

**INSEAD**

The Business School  
for the World®

# Faculty & Research Working Paper

**Electric Vehicles with a Battery  
Switching Station:  
Adoption and Environmental Impact**

---

Buket AVCI  
Karan GIROTRA  
Serguei NETESSINE  
2013/108/TOM  
(Revised version of 2013/46/TOM)

# Electric Vehicles with a Battery Switching Station: Adoption and Environmental Impact

Buket Avci\*

Karan Girotra\*\*

Serguei Netessine\*\*\*

Revised version of 2013/46/TOM

This paper can be downloaded without charge from the Social Science Research Network electronic library at: <http://ssrn.com/abstract=2005092>

\* Assistant Professor of Operations Management (ABD) at Singapore Management University, 81 Victoria Street, Singapore 188065. Email: [buketavci@smu.edu.sg](mailto:buketavci@smu.edu.sg)

\*\* Assistant Professor of Technology and Operations Management at INSEAD, Boulevard de Constance 77305 Fontainebleau Cedex, France. Email: [karan.girotra@insead.edu](mailto:karan.girotra@insead.edu)

\*\*\* The Timken Chaired Professor of Global Technology and Innovation, Professor of Technology and Operations Management at INSEAD, Boulevard de Constance 77305 Fontainebleau Cedex, France. Email: [serguei.netessine@insead.edu](mailto:serguei.netessine@insead.edu)

A Working Paper is the author's intellectual property. It is intended as a means to promote research to interested readers. Its content should not be copied or hosted on any server without written permission from [publications.fb@insead.edu](mailto:publications.fb@insead.edu)

Find more INSEAD papers at [http://www.insead.edu/facultyresearch/research/search\\_papers.cfm](http://www.insead.edu/facultyresearch/research/search_papers.cfm)

# **ELECTRIC VEHICLES WITH A BATTERY SWITCHING STATION: ADOPTION AND ENVIRONMENTAL IMPACT**

ABSTRACT. The transportation sector's carbon footprint and dependence on oil are of deep concern to policy makers in many countries. Use of all-electric drive-trains is arguably the most realistic medium-term solution to address these concerns. However, motorist anxiety induced by an electric vehicle's limited range and high battery cost have constrained consumer adoption. A novel switching-station-based solution is touted as a promising remedy. Vehicles use standardized batteries that, when depleted, can be switched for fully charged batteries at switching stations and motorists only pay for battery use.

We build a model that highlights the key mechanisms driving adoption and use of electric vehicles in this new switching-station-based electric vehicle system and contrast it with conventional electric vehicles. Our model employs results from repairable item inventory theory to capture switching station operation; we embed this model in a behavioral model of motorist use and adoption. Switching-station systems effectively transfer range risk from motorists to the station operator, who, on account of statistical economies of scale, can better manage it. We find that this transfer of risk can lead to higher electric vehicle adoption than in a conventional system, but it also encourages more driving than a conventional system does. We calibrate our models with motorist behavior data, electric vehicle technology data, operation costs and emissions data to estimate the relative effectiveness of the two systems under the status quo and other plausible future scenarios. We find that the system that is more effective at reducing emissions is often less effective at reducing oil dependence, and the misalignment between the two objectives is most severe when the energy mix is coal heavy and with advanced battery technology. Increases in gasoline prices (by imposition of taxes, for instance) are much more effective in reducing carbon emissions while battery-price reducing policy interventions are more effective for reducing oil dependence. Taken together, our results help a policy maker identify the superior system for achieving the desired objectives. They also highlight that policy makers should not conflate the dual objectives of oil dependence and emissions reductions as the preferred system and the policy interventions that further that system may be different for the two objectives.

## 1. INTRODUCTION

The transportation sector is a substantial contributor to carbon dioxide emissions (20%-25% share), with its emissions growing faster than in any other energy-using sector (here and later, see World Energy Council (2007)). Carbon emissions contribute to global warming that is associated with climate change, which is likely to have catastrophic economic, social and moral consequences. Further,

over 95% of transport energy comes from oil. The supply of oil is concentrated in parts of the world, and a transportation sector dependent on oil is exposed to significant geopolitical oil supply risks.

Means of transportation that can diversify the sources of transportation energy to reduce oil dependence and decrease the carbon footprint of this sector have thus attracted increasing attention from environmentalists, governments, industry and academics. Vehicles with alternate drive-train technologies including electrical, bio-fuel, hydrogen and natural gas, all hold the promise of reducing oil dependence and carbon emissions, but, with rare exceptions, implementation of these technologies is currently very limited due to technological, political and other issues (see Struben and Sterman (2008) for historical notes). Electric drive-trains are perhaps the most technologically advanced amongst these choices: electric vehicles have a lower per-mile carbon footprint than gasoline vehicles, and the electricity used to power them can be produced from a variety of sources besides oil. Thus, use of electric vehicles is perhaps the most realistic medium-term solution to reduce oil-dependence and carbon emissions. Multiple countries including the United States, France and China (U.S. Department of Energy (2011); Kroon et al. (2012); China Daily July 30 (2012)) have thus set objectives for electric vehicle adoption in an attempt to achieve the dual goals of limiting oil dependence and reducing carbon emissions.

Electric vehicles (EVs) historically predate gasoline vehicles, but have only received mainstream interest in the last decade (see Eberle and Helmolt (2010)). The first mass-produced hybrid gasoline-electric vehicle, the Toyota Prius, was introduced in 2003, and the first mass-use battery-powered electric car, the Nissan Leaf, in 2010. Most other major automakers are in the process of launching their own versions of electric vehicles. While electric vehicles are arguably the most promising of all alternative technologies, the adoption of electric vehicles has been minimal, mainly due to two widely accepted limiting factors. The first is *range anxiety*, a term introduced to highlight the fear that a vehicle has insufficient range to reach its destination (Eberle and Helmolt (2010)). While this term equally applies to electric and gasoline vehicles, the former usually have range limitations of about 100 miles on a single charge, and unlike its gas-fueled counterpart, an electric vehicle takes hours to recharge. The second factor is the cost of the battery (around \$15,000 for a 24KWh battery that powers a small-mid size car), which is typically the most expensive component driving the cost difference between electric and gasoline vehicles. Although the running cost of an electric vehicle is far lower than that of a gasoline vehicles, the higher upfront costs deter many adopters despite governmental subsidies and tax breaks. Over the last 150+ years, numerous technological advances have been targeted towards making cheaper batteries with longer range but, to this point, their success has been insufficient.

Some recently established firms, such as Tesla Motors and the now failed start-up Better Place (Girotra et al. (2011)) are attempting to address these two limiting factors, through the use of a novel mobility system that combines (1) a network of battery switching stations and (2) a payment system such that the motorist is charged per mile driven while the company owns the batteries. The switching stations would be widely accessible and would allow a motorist to exchange a depleted battery for a fully charged one in 90 seconds or less. Since the motorists would potentially have different batteries at different points of time, the batteries would be owned by the firm. Thus, rather than paying the large upfront cost of the battery, the motorist would pay for battery use measured as miles driven. This mobility system still includes the traditional charging stations at a number of locations, with all electricity costs paid by the firm. Components of this system are not entirely new: switching stations have been long used for forklift trucks (Timmer (2009)), and purchase subsidy combined with pay-per-use contracts have long been used by mobile phone companies among others. The novel mobility system combines the two elements.

The advantages of this switching-station mobility system are apparent: it eliminates the two key barriers to adoption of electric vehicles described above. There are, however, some hidden, as yet unstudied, disadvantages. In addition to the extensive charging infrastructure and the need to standardize batteries to make them swappable, the mobility system must hold more batteries than the number of cars deployed. Presumably, the cost of these (very expensive) extra batteries will depend on the demand dynamics and the service level that the company wants to provide at the switching station. Nevertheless, switching station systems have attracted a lot of attention, with venture capitalists valuing the pioneer of this system, Better Place at over \$2.25B at its peak, the first annual Green Car Breakthrough Award given to the company, and several countries (including Israel, Denmark, China and Australia) signing agreements with Better Place to deploy switching station systems, with dozens of others currently negotiating terms right now. Tesla Motors, that has arguably brought the most highly regarded electric vehicle design to the market in recent years has also co-opted this promising mobility system in its offering.

There is, to our knowledge, no rigorous analysis and comparison of this mobility system with the more conventional fixed-battery powered electric vehicle systems in terms of their ability to reduce oil dependence and carbon emissions. Conducting this study is the goal of this paper. Our first contribution is in proposing a model for the switching-station mobility system. We posit that charging and storing batteries is similar to a repairable items inventory system in which running out of charge is equivalent to “failing” and the recharging process is equivalent to “repairing”. We embed this inventory model in a model of motorist choice and provider-firm behavior in which the amount

of driving is uncertain and depends on the contractual arrangement (pay-per-use) offered by the operator to the motorist.

Our second contribution is in analyzing this model, characterizing the optimal solution, and identifying some surprising structural properties. On the motorist side, we determine the optimal driving decision and the end-state equilibrium adoption of the technology. For the mobility system operator, we find the optimal price per mile driven and the inventory of spare batteries. We show that, under very general conditions, the optimal motorist adoption and driving of electric vehicles in the switching-station system are strategic complements: that is, any policy intervention (e.g., subsidies, taxes, etc.) would have the same directional effect on both, electric vehicle adoption and driving. Interestingly, this implies that seemingly environmentally friendly policy changes (e.g., electric vehicle subsidies) would lead to higher adoption, but also to more driving of electric vehicles under the switching station system. While the former should reduce oil dependence by shifting motorists from gasoline to electric vehicles, the latter increases electricity consumption which, in most countries, is still obtained using carbon emitting technologies. We demonstrate that statistical economies of scale inherent in the switching-station mobility system is the driving force behind this result.

Our third contribution is in conducting a large-scale numerical comparison that estimates and compares the effectiveness of the two systems. We calibrate our models with motorist behavior data, electric vehicle technology data, operation costs and emissions data to identify the superior system and its effectiveness under the status quo and plausible future scenarios. We find that, with current technology and the U.S. electricity mix, a switching-station system will outperform a conventional electric vehicle system on both policy objectives. This is not the case with more carbon-heavy mix of electricity used in countries like China, where the dual policy objectives are misaligned— while switching-station systems are preferred for reducing oil dependence, conventional electric vehicle systems are better for reducing emissions. Further, this misalignment in objectives will also arise with the U.S. electricity mix with modest improvements in battery technology, projected to happen well before a switching-station system becomes a reality. On the other hand, in countries with a low carbon intensity electricity mix, such as France, the dual policy objectives are aligned so the same system achieves higher reductions in oil dependence and carbon emissions: typically this is the switching-station system. Essentially, the system that is more effective at reducing emissions is often less effective at reducing oil dependence, and the misalignment between the two objectives is most severe when the energy mix is coal heavy and when battery technology advances.

We find that an increase in gasoline price (by imposition of taxes, for instance) is much more effective in reducing carbon emissions while battery-price reducing policy interventions are more effective for

reducing oil dependence. In fact, battery price reductions (by way of purchase/research/manufacturing subsidies) and/or technology improvements may in fact be inimical to reducing emissions in the case of switching-station systems and they generally enhance the misalignment between objectives. A 50% increase in gasoline prices can almost halve the emissions and double adoption in each system, whereas a 50% reduction in battery prices can increase adoption four fold while achieving only ~ 10% reduction in emissions.

Taken together, our analytical and calibrated numerical analysis can support policy makers in three ways: First, our analysis identifies the preferred electric vehicle system to achieve the objectives of reduction in oil dependence and emissions. Policy makers should choose the prescribed system as per their preferred objective, and then create conditions to facilitate its introduction and adoption. Second, we illustrate that policy makers should not conflate the dual objectives of oil dependence and emissions reductions;<sup>1</sup> the preferred system and the policy interventions that further that system may be different for the two objectives. Finally, our comparison of policy interventions suggests that increases in gasoline taxes are more effective for carbon emission reduction, while reductions in battery prices are more effective in reducing oil dependence.

## 2. LITERATURE REVIEW

Our work contributes to the growing sustainable operations management literature. Sustainability has become a prominent topic in operations management over recent years, especially given the growing interest in the effects of global warming and corporate social responsibility. Kleindorfer et al. (2005) provide a review of papers integrating sustainability into operations management published in the first 50 issues of the journal *Production and Operations Management*. Adoption of green practices and associated arrangements is a key topic in the sustainable operations literature. Corbett and Muthulingam (2007) study the adoption of green practices using empirical data to identify the limiting factors. Lobel and Perakis (2011) develop a model for the adoption of solar photovoltaic technology by residential consumers. Akin to the battery contract in this paper, Agrawal et al. (2012) study the environmental impact of pay-per-use contracts (leasing) versus outright purchases in the context of durable products. Taking a life-cycle environmental impact perspective, they identify conditions such that leasing is a superior strategy for the provider firm. These papers study the same adoption and environmental impact issues we do, but for products that do not have any of the demand and use dynamics arising from driving, charging, and battery-switching in our model.

---

<sup>1</sup>As is the case in the official policy statements of the U.S. (U.S. Department of Energy (2011)), France (Kroon et al. (2012)) and China (China Daily July 30 (2012))

The research on electric vehicles in operations management is extremely limited. Chocteau et al. (2010) use cooperative game theory to investigate the impact of collaboration and intermediation on the adoption of electric vehicles among commercial fleets, and they determine the conditions under which adoption becomes economically feasible. Sioshansi (2012) presents an analysis of individual drivers' plug-in hybrid electric vehicle charging patterns under various electricity pricing tariffs and compares the cost and emissions impacts of these charging patterns. Mak et al. (2013), to the best of our knowledge, is the only paper that studies a switching-station model. Mak et al. (2013) develop models that help the planning process for deploying battery switching network infrastructure and the battery management at the switching stations. Our analysis includes the battery management problem in a similar way, but we examine the effectiveness of a switching-station model in reducing carbon emissions and oil dependence. Struben and Sterman (2008) models the dynamics of alternative fuel vehicle adoption, taking into consideration mechanisms driving consumer adoption. While this paper studies diffusion of a pre-selected electric vehicle system, we do study the effectiveness of different electric vehicle systems.

The analysis in this paper uses the results developed in two streams of literature: The repairable item inventory planning and the contracting (principal-agent) literatures. Repairable inventory models such as the METRIC model (Sherbrooke (1968)) have been widely applied to the management of critical spare parts for the aerospace and defense industries (cf. Muckstadt (2005) for recent developments). The switching station in our model can be thought of as an application of this literature to a novel context where an inventory of electric vehicle batteries at switching stations must be managed. Taken together, to the best of our knowledge, our paper is the first to model the effectiveness of different electric vehicle systems for decreasing oil dependence and greenhouse gas emissions.

### 3. ELECTRIC VEHICLES: ALTERNATIVE BUSINESS MODELS

We develop a model of a population of motorists that make utility-maximizing choices between electric and fossil-fuel vehicles, taking into account subsequent utility from the use of the vehicle. We consider the effectiveness of two alternative electric vehicle systems: 1) The *Conventional Electric* vehicle system, whereby an electric vehicle with limited range is sold to a motorist, and 2) the *Switching-Station* system, whereby the motorist has access to a network of "switching stations", which allow the exchange of depleted batteries for fully charged, thereby enhancing the range of the vehicle. In the former system, a profit-maximizing firm prices and sells a vehicle with a battery to the motorist. In the latter model, a profit-maximizing firm establishes and stocks the switching stations, and prices the service per mile driven. Motorists make utility-maximizing choices about whether to adopt electric vehicles and how much to drive. We next present a model that captures



the most salient features of this setup; an extensive discussion of alternative assumptions and model enhancements is provided in the concluding sections.

### 3.1. Motorist Behavior.

3.1.1. *Utility from owning a vehicle.* We base our model of motorist behavior on existing empirical work describing driving habits. Precise estimates of all parameters in the motorist behavior model described below are provided in the scenario analysis section. We capture a motorist's utility through four additive components:

- (1) *Utility from driving:* Motorists derive utility from how much they drive each day. This utility,  $u(\cdot)$ , is increasing in the miles driven, with diminishing marginal returns,  $u'(\cdot) > 0$ ,  $u''(\cdot) < 0$ .
- (2) *Range Inconvenience:* Motorists incur a disutility,  $M$ , whenever their daily driving exceeds the range of the vehicle,  $R$ .<sup>2</sup> This disutility includes the inconvenience from waiting for the electric vehicle battery to be recharged, excessive depreciation of the battery if using a fast-charge option, and even using an alternate means of transport to reach a destination, etc.<sup>3</sup>
- (3) *Green Utility:* Motorists derive additional utility from owning electric vehicles: a "green" utility. This green utility varies in our population of motorists. In particular, we assume that our population's green utility,  $\tilde{U}_{gr}$  is uniformly distributed in the interval  $[0, d]$ .
- (4) *Direct Costs:* Motorists incur the costs of owning and operating the vehicle. Depending on the vehicle type and associated operating model, this potentially includes the initial purchase price of the vehicle, the fuel, the electricity, the battery or per-mile charges, taxes and repairs. We normalize the initial purchase price of a fossil-fuel vehicle and that of an electric vehicle without batteries to zero.<sup>4</sup> Further, we assume that the life-cycle of all vehicles is the same.

We assume that the distance driven per day by a motorist has a planned or controlled component,  $e$ , and an unplanned or random component,  $\epsilon$ . The planned component captures the average daily distance that a motorist anticipates or plans to drive based on the best information available on driving needs and costs at the time of vehicle purchase. The unplanned component captures any additional

<sup>2</sup>Most electric vehicle batteries can be fully recharged in less than 8 hours, typically during the night. Due to the limited availability of a charging-point network, they are rarely charged during the day (cf. Denholm and Short (2006) for charging characteristics). Thus, our model assumes that each day the full range of the battery is available. With simple modifications, we can also consider cases in which less than the range is available due to an inability to charge during the night, or more than the range is available due to charging during the day. Neither case alters our main insights.

<sup>3</sup>All results in the subsequent sections also hold if we assume different range-inconvenience disutilities for gasoline, conventional electric and switching-station models.

<sup>4</sup>90% or more of the incremental cost of electric vehicles arises out of the battery pack that comprises individual battery modules, an enclosure for the modules, management systems, terminals and connectors, and any other pertinent auxiliaries (Simpson (2006); Pistoia (2010)). We note that this normalization is not essential, i.e., any difference in the initial purchase prices can be captured by the green utility,  $\tilde{U}_{gr}$ , which can be interpreted as the additional utility (or disutility) from owning an electric vehicle, including any purchase, tax subsidies, etc.

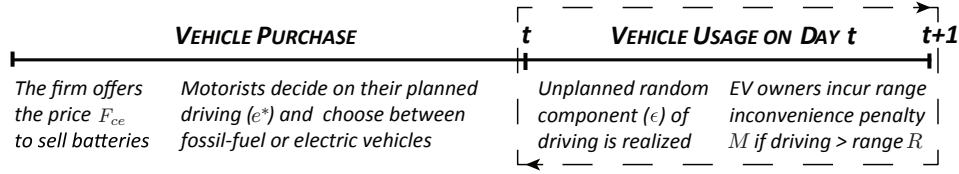

FIGURE 3.1. Sequence of Events with Conventional Electric Vehicles

driving due to subsequent changes in life situation, driving needs, costs of driving, unexpected detours on any day, traffic conditions, etc. In contrast to the planned component, the unplanned driving is realized on a daily basis and is unknown at the time of the purchase. Hence, at the time of purchase, we model this unplanned driving as a random variable,  $\epsilon$ , that will be drawn each day from a zero-mean, finite-variance distribution with density  $g(\cdot)$  and inverse cumulative distribution function  $\bar{G}(\cdot)$ .

3.1.2. *Status Quo: Fossil-Fuel Vehicles.* With the extensive network of gas stations, fossil-fuel vehicles essentially have an unlimited range and consequently motorists who decide to own such a vehicle never incur range inconvenience, nor do they derive any green utility. The direct costs of use of such a vehicle include the purchase price of the vehicle and the fuel costs for each mile. A utility-maximizing owner of such a vehicle can maximize her ownership utility by planning to drive  $e_g$  miles per day, such that  $E_{\epsilon} [u'(e_g + \epsilon)] = c_g$ , where  $c_g$  is the per-mile fuel cost. If this utility is positive, the motorist purchases the vehicle, else she does not own a vehicle. Specifically, owners earn an expected daily utility,  $U_g \equiv (E_{\epsilon} [u(e_g + \epsilon)] - c_g e_g)^+$ , and drive  $e_g^* \equiv e_g \cdot I \{E_{\epsilon} [u(e_g + \epsilon)] > c_g e_g\}$  miles, where  $I$  is the indicator function.

### 3.2. Conventional Electric Vehicles.

3.2.1. *Preliminaries.* Owners of conventional electric vehicles buy a vehicle with a battery installed and are responsible for all subsequent costs. Specifically, the conventional electric vehicle operating model proceeds along the following steps (Figure 3.1). First, the provider firm offers a selling price,  $F_{ce}$ , the price premium for the electric vehicle over and above fossil-fuel vehicles. Motorists choose between fossil-fuel or electric vehicles based on their expected utility of ownership, and they then decide on the planned driving,  $e^*$ , based on the relevant marginal costs and benefits. Finally, for each day of ownership, the random unplanned component of driving is realized. If electric vehicle owners end up driving more than the range of the battery, they incur the range-inconvenience penalty.

3.2.2. *Electric Vehicle Pricing, Adoption and Use.* As is typical in sequential games, we solve for the equilibrium choices using backward induction, starting from the planned driving best response,

followed by the adoption response and the pricing decisions. Owners of electric vehicles plan driving to maximize expected utility from their use of the vehicle. Specifically, motorists solve the following optimization problem to obtain their optimal driving best response:

$$\max_e \left[ E \left[ u(e + \epsilon) \right] - c_e e - M \cdot \bar{G}(R - e) \right],$$

where  $c_e$  is the per-mile operating cost, in this case, the cost of charging and maintaining the battery.<sup>5</sup> The utility from ownership of the vehicle, denoted by  $U_{ce}$ , is the above maximized use utility plus the green utility,  $\tilde{U}_{gr}$ , minus the purchase price,  $F_{ce}$ .<sup>6</sup> The motorists for whom this utility exceeds the utility from a fossil-fuel vehicle (which we assume to be the status quo) will migrate to electric vehicles. The provider firm must decide on the purchase price,  $F_{ce}$ , to charge for the batteries.<sup>7</sup> Increasing the purchase price increases margins but reduces the ownership utility and consequently the adoption of and demand for electric vehicles. The firm trades off these two concerns to arrive at the optimal price. Specifically, the firm solves the following maximization problem:

$$\max_{F_{ce}} \mathbf{E} [I \{U_{ce} > U_{gas}\} \cdot (F_{ce} - c)],$$

where  $c$  is the cost of battery normalized to a daily level.

**Lemma 1. *Equilibrium Adoption and Driving of Conventional Electric Vehicles***

a) *Owners of conventional electric vehicles plan on driving  $e_{ce}^*$  miles, where  $e_{ce}^*$  is such that*

$$(3.1) \quad E \left[ u'(e_{ce}^* + \epsilon) \right] - M \cdot g(R - e_{ce}^*) = c_e.$$

b) *The firm prices the battery such that, in equilibrium,  $A_{ce}^*$  fraction of motorists adopts the vehicles*

$$(3.2) \quad 2dA_{ce}^* = E \left[ u(e_{ce}^* + \epsilon) \right] - c_e e_{ce}^* - M\bar{G}(R - e_{ce}^*) + d - U_g - c.$$

*Proof.* Detailed proofs are provided in the accompanying technical appendix. □

The equilibrium driving decision (Eq. 3.1) is determined by: the trade-off between the motorist's marginal gain from an extra mile of driving utility; the change in the risk of incurring the range-inconvenience penalty; and the marginal cost of driving consisting of the per-mile costs of charging and maintaining the battery. The adoption decision (Eq. 3.2) is driven by the pricing of the firm. Our setup is similar to a monopoly pricing situation in which the uniformly distributed green utility

<sup>5</sup>To guarantee a unique solution, we subsequently assume  $E \left[ u''(e + \epsilon) \right] + Mg'(R - e) < 0$ .

<sup>6</sup>All utility and cost values are normalized to a daily level with the daily purchase price  $F_{ce}$  leading to a total purchase price of  $F_{ce} (1 - (1 + i)^{-t}) / i$  with an interest rate of  $i$  and total days of ownership of  $t$ .

<sup>7</sup>Note that in our model, the provider firm has pricing power with respect to the selling price of electric vehicles, but the price of a fossil-fuel vehicle is exogenous (and normalized to zero). This assumption is consistent with the highly competitive fossil-fuel vehicle market and the much less competitive electric vehicle market.

leads to a traditional linear downward-sloping demand curve. As is typical in such a setting, the profit-maximizing price of the vehicle is such that it attracts half the viable market, that is half of the population for whom the utility of owning the vehicle is higher than the cost. In our setup, this is half of the maximum ownership utility,  $E_{\epsilon}[u(e_{ce}^* + \epsilon)] - c_e e_{ce}^* - M\bar{G}(R - e_{ce}^*) + d$ , minus the gasoline utility,  $U_g$ , and the incremental cost of provisioning electric vehicles, the cost of battery,  $c$ .

As expected, the adoption and driving decrease in the per-mile cost of battery charging and maintenance and a higher average green utility increases the adoption of electric vehicles. Further, Lemma 1 highlights the two key effects of the limited range of conventional electric vehicles. First, motorists who own such vehicles face the risk of exceeding the battery range. While the direct marginal costs of driving would suggest an average driving level such that  $E_{\epsilon}[u'(e_{ce}^* + \epsilon)] = c_e$ , due to the range-inconvenience penalty,  $M$ , average driving is lowered and higher values of the penalty or a smaller values of range lead to less driving as captured by Eq. 3.1. Second, range anxiety also reduces the adoption of electric vehicles, as is evident from Eq. 3.2. Hence, our model captures the two key features that are relevant in this setting. Owners of electric vehicles are anxious about exceeding the vehicle's range, so they plan to drive it less, which reduces their utility from owning an electric vehicle. This observation implies that only those motorists who highly value having a green vehicle would buy it, so fewer motorists switch to electric vehicles than would if electric vehicles had an unlimited range.

### 3.3. Electric Vehicle with a Switching Station.

3.3.1. *Preliminaries.* The setup of our model is inspired by and directly follows the operating model of the electric vehicle startup, Better Place (Girotra et al. (2011); Mak et al. (2013)). There are two main points of departure from the conventional electric vehicle model above. 1) Instead of incurring the range-inconvenience penalty, motorists whose driving exceeds the vehicle's range can now utilize a battery switching station. This switching station has a limited stock of fully charged batteries and the motorist can swap her depleted battery for a fully charged battery. The received depleted batteries are plugged in to charging bays and once charged, they are moved to the stock of fully charged batteries. 2) Instead of paying directly for the electricity consumed to charge the electric vehicle or for the battery, the motorist pays the provider firm for miles driven. The provider firm incurs the cost of charging and maintaining the batteries, be it batteries obtained at the switching station or charged at home. The switching station business model proceeds as follows (Figure 3.2). The provider firm proposes a price for the vehicle,  $F_{ss}$ , sets a per-mile price,  $p_{ss}$ , and commits to providing a level of availability for charged batteries. Based on these terms and their idiosyncratic preference for a green vehicle, motorists choose between it and a fossil-fuel vehicle. Based on the

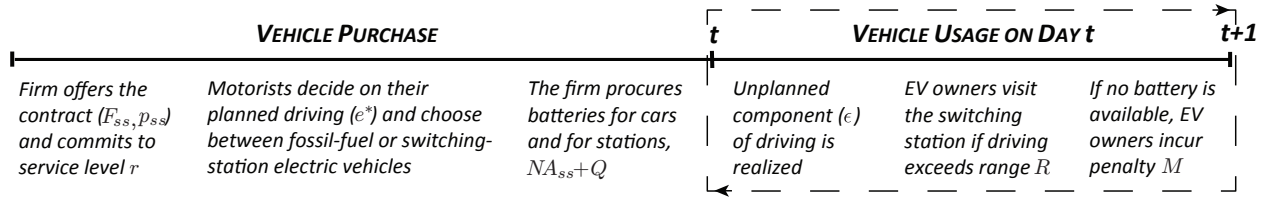

FIGURE 3.2. Sequence of Events in a Switching-Station Model

fraction of the population that adopts electric vehicles, the provider firm procures batteries both for cars and for the switching station. Motorists decide on their planned driving. Finally, for each day of ownership, the random unplanned component of driving is realized. If electric vehicle owners end up driving more than the vehicle’s range, they visit the switching station. If the station has batteries in stock, the motorist drives away with a replenished battery. If she does not find a battery in stock, she incurs the range-inconvenience penalty. We formulate this problem as a sequential game in which the firm decides on the stocking level of batteries and the pricing while motorists select their vehicle types and daily driving. Identifying the equilibria in this game requires us to analyze the operational dynamics of the switching-station model embedded within a pricing and consumption game.

3.3.2. *Analysis of the Switching Station.* At the heart of this novel operating system for electric vehicles lies the switching station. There are two components to analyzing this system. 1) the demand process that arises from motorists driving and exceeding the vehicle range; and 2) the charging facility.

*Demand Process:* Demand for a battery occurs when any motorist exceeds the range of the vehicle, i.e., with probability  $\bar{G}(R - e_{ss})$ , where  $e_{ss}$  is the planned driving. Consider a market with a population of  $N$  motorists, of which a fraction  $A_{ss}$  adopts these electric vehicles. Assuming  $N$  is large, the probability  $\bar{G}(R - e_{ss})$  is small and the arrivals are stationary,<sup>8</sup> the demand at the switching station is a Poisson process with a mean arrival rate  $A_{ss}N \cdot \bar{G}(R - e_{ss})$  (Karlin and Taylor (1975)).<sup>9</sup>

*Charging Facility:* We conceptualize the charging facility (as illustrated in Figure 3.3) as a repairable spare parts facility (see Muckstadt (2005)). Depleted batteries correspond to broken parts, the charging process to the repair process, and charged batteries to the stock of spare parts. We adapt

<sup>8</sup>For a typical US motorist, the probability  $\bar{G}(R - e_{ss})$  is only 6% (based on a battery range of 100 miles (Better Place Blog (2011)) and daily driving distributions provided by the US Department of Transportation Federal Highway Administration (Hu and Reuscher (2004))). See the data-driven analysis in Section 5 for details.

<sup>9</sup>Mak et al. (2013) directly uses a Poisson process to model the demand arrival at a switching station. The fixed demand rate assumption is in fact an approximation, because the closed-loop cycle with finite population means  $\lambda\tau$  is a function of the number of operating cars. For example, in the case that a replacement is not available and a back-order occurs, the motorist waits at the station until the battery is charged. As the car is not operating in this case, the population size decreases. However, the approximation of the fixed-demand rate is reasonable in our problem context because in practice the expected back-orders at any time are fewer than  $\lambda\tau$  and  $\lambda\tau \ll N$ . This ensures that, on average, the number of motorists waiting at the station at any given time is relatively small, and the correction due to state dependency can be safely ignored.

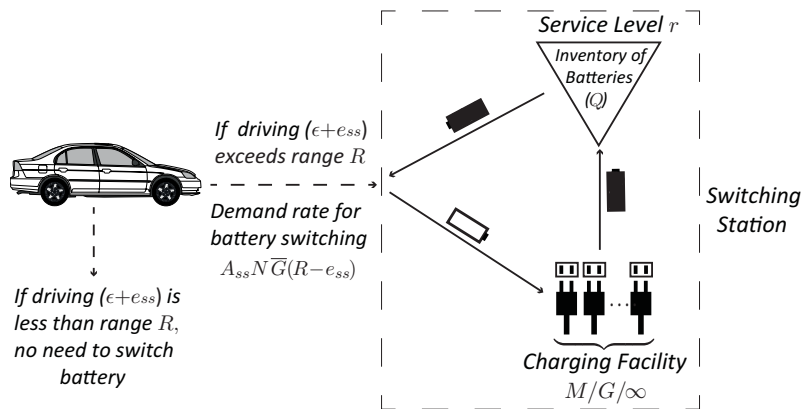

FIGURE 3.3. Operation of the Switching-Station Model

and develop the extensive literature on managing spare parts inventory to our setup. The battery charging process takes a random amount of time, with a mean service time of  $\tau$  time units. As is typical in these stations, a large number of (cheap) charging bays is available so “repair” capacity is not constrained. Once the battery is fully charged, it is placed in the station’s inventory. As suggested by Mak et al. (2013), we assume that the charged batteries are reused in a first-in-first-out (FIFO) order. This charging process can be modeled as an  $M/G/\infty$  queuing system, which is a typical assumption in the repairables literature. The provider firm chooses a spare battery inventory level,  $Q$ . At any given point in time,  $O$  of these batteries are in the process of being charged, while  $(Q - O)^+$  others are available for arriving motorists. If a motorist arrives and no battery is available,  $Q < O$ , she incurs the range-inconvenience penalty, and we assume that she waits at the station for a new battery; that is, her demand is back-ordered. From Palm’s theorem, we know that, in a steady state,  $O$  is Poisson-distributed. Following standard practice for large-scale repairable service parts systems (see Kim et al. (2007)), for all further analysis we analyze  $O$  as a continuous random variable that is distributed normally with mean and variance  $\tau A_{ss} N \cdot \bar{G}(R - e_{ss})$ . Further, we advance the standard setup by taking a slightly more complex and, we believe, more realistic approach by considering the standard deviation to be a function of the motorist’s decision  $e_{ss}$ , which allows us to consider even the second-order effect of the motorist’s demand choices, which turns out to be important.

**3.3.3. Electric Vehicle Pricing, Adoption, Switching-Station Management and Driving.** As is typical in sequential games, we solve for the equilibrium using backward induction. We start with the last step, the optimal driving best response,  $e_{ss}$ , followed by the number of batteries stocked at the switching station,  $Q$ , the pricing for this service,  $(F_{ss}, p_{ss})$ , and the resulting adoption  $A_{ss}$  of electric

vehicles. An owner of a vehicle plans her driving level,  $e_{ss}^*$ , to maximize her utility

$$e_{ss} = \arg \max_e \left[ E [u(e + \epsilon)] - p_{ss}e - M(1 - r) \cdot \bar{G}(R - e) \right].$$

<sup>10</sup>Note here that the motorist now incurs the range-inconvenience penalty only when the charging facility is out of stock, i.e., with probability  $1 - r$ , where  $r$  is the availability promised by the service provider.<sup>11</sup>, <sup>12</sup> This is a lower penalty than that of a conventional electric vehicle. The utility from ownership of the vehicle is the above optimal use utility plus the idiosyncratic green utility,  $\tilde{U}_{gr}$  minus the purchase price,  $F_{ss}$ . A fraction,  $A_{ss}$ , of motorists finds this utility to be higher than the utility from a gasoline vehicle, and they adopt the electric vehicle. Anticipating these driving levels and adoption rates, the firm selects the fixed fee and the per-mile fee for the service to maximize its profits while ensuring that it stocks enough batteries to meet the promised service level.<sup>13</sup> Specifically,

$$\begin{aligned} \max_{F_{ss}, p_{ss}, Q} \mathbf{E} [N A_{ss} (F_{ss} + (p_{ss} - c_e) e_{ss} - c) - cQ], \\ \text{s.t. } Pr(Q > O) \geq r. \end{aligned}$$

For each adopting motorist, the profits for the firm include the revenues from the sale of the vehicle,  $F_{ss}$ , the profits from the miles driven,  $(p_{ss} - c_e) e_{ss}$ , the costs of batteries in the vehicle,  $c$ , and the per-motorist costs of batteries at the station,  $cQ/NA_{ss}$ .<sup>14</sup> In addition to the purchase price of the vehicle, the firm now also has the per-mile price to maximize its profits. The solution is as follows:

**Lemma 2. *Equilibrium Outcomes for the Switching-Station Model:*** *The equilibrium driving,  $e_{ss}^*$ , adoption,  $A_{ss}^*$ , stocking level,  $Q^*$ , and per-mile price,  $p_{ss}^*$ , are the solutions to the following*

<sup>10</sup>Note that we focus on the part of solution space where  $R - e > 0$  because a solution where all motorists drive more than the range of the vehicle is neither sustainable (for the switching station firm) nor reasonable.

<sup>11</sup>Note that, in our setup, the probability that a motorist will find a charged battery in stock (the in-stock probability) corresponds to the steady state probability that the station is in stock (the fill rate), due to the Poisson Arrivals See Time Averages (PASTA) property of our setup (Wolff (1982)).

<sup>12</sup>All our results continue to hold even in a hypothetical scenario in which the service levels were endogenously chosen by the switching station operator to manage the adoption-cost trade-off such that it maximizes profits.

<sup>13</sup>Better Place subscribers are guaranteed access to an inventory of batteries with a committed service level agreement (Better Place (2011a)).

<sup>14</sup>To ensure a non-trivial ( $p_{ss} \neq 0$ ) and unique pricing solution, we assume that the firm's profit is concave in the driving level,  $e_{ss}$ . Technically, this corresponds to a condition on the shape of the distribution of the unplanned driving, the service level and the battery range:  $\chi(e_{ss}, A_{ss}) = \delta + \tau z_r (4\bar{G}(x)\sqrt{v})^{-1} g^2(x) + \tau g'(x) (1 + z_r(2\sqrt{v})^{-1}) < 0$ , where  $x = R - e_{ss}$ ,  $\delta = E(u''(e_{ss} + \epsilon)) + M(1 - \alpha) \cdot g'(x)$  and  $v = \tau A_{ss} N \cdot \bar{G}(R - e_{ss})$ . This assumption holds for all distributions with a decreasing failure rate; for example, the Gamma distribution with a shape parameter less than 1. Further, it often holds also for distributions with an increasing failure rate with mild restrictions on other parameters: for example, the triangular and normal distributions also work when the battery in-stock service level,  $r$ , is not vanishingly close to 1 and the optimal driving  $e_{ss}^*$  is not too close to the range  $R$ . We also assume that this concavity is large enough at the optimum such that the Hessian  $H(e_{ss}^*, A_{ss}^*)$  is positive. Formally, we assume that  $H = \gamma/\delta \left( \tau z_r \cdot g(x) \cdot e_{ss} \cdot (4d\sqrt{v})^{-1} + A_{ss} \chi/\delta \right) - d^{-1} (\tau z_r)^2 \cdot g^2(x) (4\delta\sqrt{v})^{-2} > 0$ , at  $e_{ss} = e_{ss}^*$  and at  $A_{ss} = A_{ss}^*$ , where  $\omega = \tau z_r \cdot \bar{G}(x) (4dA_{ss}\sqrt{v})^{-1}$  and  $\gamma = N/d(-2 + \omega)$ .

system of equations. First, there is the driving equation,

$$(3.3) \quad E_{\epsilon} [u'(e_{ss}^* + \epsilon)] - M(1-r) \cdot g(R - e_{ss}^*) = p_{ss}^*.$$

Next is the stocking-level equation,

$$(3.4) \quad Q^* = \tau A_{ss}^* N \cdot \bar{G}(R - e_{ss}^*) + z_r \left( \tau A_{ss}^* N \cdot \bar{G}(R - e_{ss}^*) \right)^{1/2},$$

the pricing equation,

$$(3.5) \quad p_{ss}^* = c_e + c \cdot g(R - e_{ss}^*) \cdot \Omega(e_{ss}^*, A_{ss}^*),$$

and finally the adoption/purchase price equation,

$$(3.6) \quad 2dA_{ss}^* = E_{\epsilon} (u(e_{ss}^* + \epsilon)) - c_e e_{ss}^* - \varphi(e_{ss}^*, A_{ss}^*) \cdot \bar{G}(R - e_{ss}^*) + d - U_g - c,$$

where  $\Omega(e_{ss}^*, A_{ss}^*) \equiv \tau + 1/2\tau z_r \left( \tau N A_{ss}^* \bar{G}(R - e_{ss}^*) \right)^{-1/2}$  represents the change in the stocking level with respect to the demand at the switching station and  $\varphi(e_{ss}^*, A_{ss}^*) \equiv M(1-r) + c\Omega(e_{ss}^*, A_{ss}^*)$  represents the total expected penalty incurred in the system (the motorist+the firm) per motorist demand at the switching station.  $z_r$  is the standard normal  $z$  value.

Equation 3.3 describes the motorist's decision regarding planned driving. As with conventional electric vehicles, motorists trade off their utility from driving additional miles, the risk of incurring the range-anxiety penalty, and the per-mile costs of driving. However, there are two departures. First, the range-inconvenience penalty is now limited only to instances in which the switching station is out of batteries, which happens with probability  $1 - r$ . Second, the marginal cost of driving an additional mile is not the cost of maintaining and charging the battery, but the price that the motorist pays to the provider firm. The stocking-level equation (Eq. 3.4) describes the batteries required to meet the service level constraints. As expected, the constraint is binding and the optimal stocking level follows directly from the amount required to fulfill the service level constraints.

The pricing equation (Eq. 3.5) characterizes the per-mile price. A decrease in the price of miles incentivizes motorists to drive more, hence increasing firm sales, but reducing margins. This trade-off can be managed by using the two-part pricing scheme, i.e., using the purchase and the per-mile prices. In particular, from traditional models of two-part pricing with downward sloping demand curves, one would expect the firm to set the per-mile price equal to the marginal cost of servicing the mile and then to use the purchase price to extract the surplus, with the marginally green motorist earning zero utility. This is indeed the case in our setup, but the cost of servicing a mile is very different. There are two components to this cost. First, there is the cost of maintaining and charging



the battery,  $c_e$ , which is the same as that for the conventional electric vehicles (see the first part of the RHS in Eq. 3.5). Second, for each additional mile driven, there is the cost of servicing this mile at the switching station. In particular, the firm is now more likely to see demand for a charged battery at the station and it must increase its stock of charged batteries. These costs are captured by the second part of the RHS of Eq. 3.5. In equilibrium, the firm sets the per-mile price equal to this total cost. The per-mile price can be interpreted as the costs of charging and maintaining the battery plus an insurance premium— an additional amount paid to limit the range risk. This insurance premium is captured by the second term in Eq. 3.5. It increases in the battery cost, the charging time and the promised service level. The first part of the expression  $\Omega$  reflects the increase in stock due to an increase in the mean demand at the station, while the second reflects the increase in the safety stock.

Finally, Eq. 3.6 describes the adoption level, which is driven by the vehicle's purchase price. As before, decreasing the price increases adoption but reduces revenues. The optimal purchase price is such that the firm captures half the viable market, that is half the customers with green utility between the utility of gasoline vehicles and electric vehicles with the mid-point customer earning zero utility. We next state a fundamental result that drives subsequent results.

**Theorem 1.** *The optimal customer adoption and driving in a switching-station model are strategic complements, formally (with a slight abuse of the notation)  $\partial A_{ss}^*/\partial e_{ss}^* > 0$ . This implies that any policy intervention through a change in any exogenous parameter  $X$  will have the same directional effect on adoption and driving. Formally,*

$$\text{sign} \left( \frac{\partial A_{ss}^*}{\partial X} \right) = \text{sign} \left( \frac{\partial e_{ss}^*}{\partial X} \right).$$

The above theorem highlights an important property of the equilibrium outcome in the switching-station model: the relationship between equilibrium adoption and driving. Namely, optimal adoption increases in optimal driving and optimal driving increases in optimal adoption. This observation has important implications for policy-makers trying to create a favorable environment for switching-station vehicles. Policy actions can be thought of as changes to the parameters within which the switching-station model must operate. For example, a battery subsidy can be thought of as a policy intervention that reduces battery prices,  $c$ . An electric vehicle purchase subsidy can be thought of as a change to the motorist's green utility, i.e.,  $d$ . Our theorem suggests that battery subsidies, electric vehicle purchase subsidies, changes in electricity/gasoline prices, customer inconvenience and other costs, will all have the same directional effect on adoption and driving. That is, if they increase the adoption of switching-station vehicles, they will also increase the driving of these vehicles. This

fundamental property of the switching-station vehicle will be at the root of understanding their effectiveness in decreasing oil dependence and affecting greenhouse gas emissions.

#### 4. THE EFFECTIVENESS OF THE SWITCHING-STATION MODEL

A transportation infrastructure dependent on oil is vulnerable to increasing geopolitical uncertainties and supply disruptions. Policy makers in countries with limited domestic fossil-fuel sources thus are attempting to design policies that limit dependence on imported fossil fuel, for strategic or economic reasons. For example, in Israel, the birthplace of the switching-station model, limiting dependence on imported fossil fuel is both a strategic and commercial concern.<sup>15</sup> Adoption of electric vehicles can limit oil dependence, as electricity used to power electric vehicles can be produced from a variety of energy sources, including non-oil or even non-fossil-fuel sources. This diversity in the energy source for powering electric vehicles limits the vulnerability of economies to oil price oscillations and natural or man-made oil supply disruptions. Multiple countries have set objectives to reduce oil-dependence by converting motorists from oil-based systems to electric vehicles.<sup>16</sup> Thus, a common metric for the effectiveness of an electric vehicle system in reducing oil dependence is the level of electric vehicle adoption achieved by the system in a population.

A second source of interest in electric vehicles arises from their lower per-mile carbon footprint. Carbon emissions contribute to global warming that is associated with climate change, which is likely to have catastrophic economic, social and moral consequences. Reducing the transportation sector's carbon footprint is thus a desirable goal. The per-mile carbon footprint of an electric system is typically only 40% of a gasoline system, so adoption and use of electric vehicles can change the carbon footprint of the transportation sector. Our second metric for system effectiveness, which captures the objective of carbon emissions reduction, is thus the aggregate carbon emissions from a population of motorists that can choose between gasoline and electric vehicles. Finally, electric vehicle systems may be built and operated by entities with commercial interests, and a third metric for effectiveness of the system is its profitability. We analyze these three dimensions below.

**4.1. Profitability of Different Electric Vehicle Businesses.** EV systems may be built and operated by entities with commercial interests and investors so we examine profitability first.

---

<sup>15</sup>See for instance, "Israel bids to end global oil dependency by 2020", *Haaretz*, September 19th, 2010.

<sup>16</sup>In his 2011 State of the Union address, President Obama called for putting one million electric vehicles on the road by 2015 – highlighting a goal aimed at reducing U.S. dependence on oil (U.S. Department of Energy (2011)). The U.S. Department of Energy in their February 2011 Status Report sees electric vehicles as a key pathway for reducing petroleum dependence. France set the sales goal for EVs at 100,000 cars by 2015 and 2 million cars by 2020 (Kroon et al. (2012)). The central government's plan in China, posted on its website, is targeting the production of 500,000 plug-in hybrid and electric vehicles by 2015 (China Daily July 30 (2012)). To facilitate this goal, China launched a nationwide program to install large electric system charging stations.

**Theorem 2.** 1) *Equilibrium Operating Profits:* The equilibrium operating profits of a switching-station vehicle provider,  $\Pi_{ss}^*$ , are higher than those of a conventional electric vehicle provider,  $\Pi_{ce}^*$  iff the cost of batteries,  $c$  is lower than a threshold  $\bar{c}_\pi$ , where

$$\bar{c}_\pi = \frac{2Nd(A_{ss}^{*2} - A_{ce}^{*2})}{z_r \left( \tau N A_{ss}^* \bar{G} (R - e_{ss}^*) \right)^{1/2}}.$$

2) The equilibrium profits of a switching-station vehicle provider,  $\Pi_{ss}^*$ , exhibit economies of scale with respect to the population size  $N$ . On the other hand, the equilibrium profits of a conventional electric vehicle provider,  $\Pi_{ce}^*$ , exhibit constant returns to scale. Formally,

$$\frac{\partial (\Pi_{ss}^*/N)}{\partial N} > \frac{\partial (\Pi_{ce}^*/N)}{\partial N} = 0.$$

A key difference between the two electric vehicle businesses arises from the extra batteries that must be stocked at the switching station. Thus, as Part 1 of Theorem 2 illustrates, if batteries are cheap enough, the switching-station model earns higher profits, the numerator of the threshold battery cost captures the adoption effects, while the denominator captures the safety stock effects.

Further, a switching-station system provider's profits exhibit economies of scale that arise from the key differentiating feature of the model, the switching station. The safety stock of battery inventory required at the station does not increase linearly with the number of adopting motorists. As the population and adopters increase, the statistical economies of scale in inventory kick in, which causes costs to increase in a sub-linear fashion, and profits thus exhibit economies of scale.

**4.2. Reducing Oil Dependence.** As discussed above, oil dependence reduces in direct proportion to the adoption level of different systems, thus we use the level of electric vehicle adoption in a system as our metric for system effectiveness in reducing oil dependence.

**Theorem 3. Reducing Oil Dependence:** A Switching-station system is more effective at reducing oil dependence than a conventional system iff the cost of batteries,  $c$ , is lower than a threshold  $\bar{c}$ . Formally,  $A_{ss}^* > A_{ce}^*$  iff

$$c < \bar{c} \equiv \frac{Mr}{\Omega(e_{ss}^*, A_{ss}^*)}$$

where, as before,  $\Omega(e_{ss}^*, A_{ss}^*)$ , is the increase in the switching-station cost for an additional unit of station demand.  $A_{ss}^*$ ,  $e_{ss}^*$  and  $\Omega(e_{ss}^*, A_{ss}^*)$  are given by Lemmas 1 and 2. Furthermore, the threshold battery cost,  $\bar{c}$ , decreases in the charging time,  $\tau$ , and in the per-mile cost of electric vehicle operation,  $c_e$  and increases in the market size,  $N$ , and in the per-mile cost of fossil-fuel vehicle operation,  $c_g$ .

The condition in Theorem 3 illustrates the key difference between conventional electric vehicles and switching-station systems. With conventional vehicles, motorists bear the risk of incurring the range-inconvenience penalty. In the switching-station model, customers bear the range-inconvenience penalty only with some probability,  $1-r$ , a reduction of  $r$ . The numerator of the expression represents this reduction in risk exposure and, from the customers' perspective, is a key advantage of the switching-station model. However, this model also has a disadvantage. While the customer transfers a large part of the range-inconvenience risk to the firm, the firm charges the customer for this transfer. Recall from Lemma 2, Eq. 3.5, that the firm's per-mile price is at a premium above the cost of charging and maintaining batteries, which is the per-mile price that the customer pays with a conventional electric system. This premium is the denominator of the above inequality. From the customer's point of view, if the gains from the risk transfer are higher than the loss due to the premium price, adoption is higher with the switching-station model; otherwise, conventional electric vehicles dominate.

The threshold battery cost,  $\bar{c}$ , changes with changes in charging time, per-mile costs of electric, fossil-fuel vehicle operation and, market size along expected lines, driven by the economies of scale. Interestingly, this threshold cost is lower than the threshold cost below which switching-station systems achieve higher adoption,  $\bar{c}_\pi < \bar{c}$ . This implies that there always exists a range of battery costs,  $(\bar{c}_\pi, \bar{c})$  in which the policy maker interested in achieving higher adoption prefers a switching-station system, but a commercial provider prefers to employ conventional electric vehicles.

The above discussion demonstrates the central premise for the development of the switching-station system. The results illustrate that, indeed, in certain markets, the switching-station model can increase the use of electric vehicles and thus reduce dependence on fossil fuels. The main mechanism for achieving this is the range-risk transfer from the customer to the firm. Customers pay the firm for the costs of managing this risk, which can manage it at a relatively low cost due to statistical economies of scale. However, the operation of this seemingly beneficial mechanism has an unintended, harmful, and as yet overlooked side effect that we demonstrate in the next Theorem.

**Theorem 4.** *In scenarios where the switching-station system is more effective at reducing oil dependence (adoption), customers who own switching-station vehicles drive more than they would had they adopted conventional electric vehicles. Formally,  $A_{ss}^* > A_{ce}^*$  iff  $e_{ss}^* > e_{ce}^*$ .*

The intuition behind the above result is related to the strategic complementarity between driving and adoption in switching-station models (Theorem 1). From the motorist's point of view, the switching-station model is an improvement over conventional electric vehicles due to a reduction of the range-inconvenience penalty in exchange for a premium that is relatively small and decreasing in market size. But this very reduction in the risk of incurring the range-inconvenience penalty also

incentivizes customers to drive more because, in the switching-station model, driving more does not increase the chances of being stuck with a depleted battery as much as it does with conventional electric vehicles. Further, note that the per-mile price for switching-station systems is at the cost basis because of the two-part tariff. While this total cost is indeed higher, there is no per-mile margin that the firm is charging. The two-part nature of the pricing scheme helps the firm maximize its profits and increase adoption, but not charging the customer an extra margin has an additional effect: it incentivizes the customer to drive more.

This above result is a manifestation of the well-known Jevon's paradox (Jevons (1866)) In its traditional interpretation, Jevons paradox concerns technological progress that increases efficiency, which in turn lowers the relative cost of using a resource and leads to an increase in consumption of the resource. Our result departs from the traditional interpretation in three ways: First, in our paper, we are comparing two models with two equally environmentally efficient technologies. Second, unlike in the traditional interpretation, the business model innovation of the switching-station system leads to higher per-mile usage costs than the conventional electric vehicles. The main benefit of the innovation is not in reducing costs of consumption, but in convenience. Finally, there are unique operational characteristics of the switching-station model (i.e. economies of scale) that reinforce and strengthen the Jevons paradox-like effect in our case.

Further analysis allows us to narrow down the source of this adoption-driving duality in the switching-station system. It is the economies of scale in switching station operation that lead to a cascading effect between adoption and driving. Switching stations facilitate adoption by reducing range anxiety while charging a usage premium, as adoption rises, this premium becomes smaller (economies of scale), as the premium becomes smaller, customers are incented to use/drive more, which in turn increases the desirability of the systems and leads to higher adoptions, and so on and so forth. It is this cascading effect of the economies of scale that leads to all our key structural results. We also examined a model (omitted for brevity) with a hypothetical switching station whose operation does not exhibit economies of scale. With this model, all our key structural results disappear or become much less likely to arise, thus confirming that the economies of scale that we capture in our detailed operational model of switching stations are at the root of our results.

Taken together, this discussion illustrates that the two key departures of the switching-station model—reduced range-anxiety and a pricing scheme in which the upfront costs are reduced and the provider firm is also paid for the miles driven— both help incentivize the adoption of electric vehicles, but they both do so by increasing average planned driving. In fact, our analysis illustrates that there

is a one-to-one correspondence between adoption and driving which, as we will show shortly, has important implications for the environmental impact of switching-station systems.

**4.3. Reducing Carbon Emissions.** In most countries, electricity is produced using a combination of non-renewable and renewable sources of energy (Ambec and Crampes (2010)). Irrespective of the exact composition of electricity in most countries, systems that use contemporary electric power-trains have lower per-mile emissions than systems that use fossil-fuel-based power-trains (International Energy Agency (IEA) (2010)). Thus, electric vehicles supposedly lie at the heart of establishing a sustainable transportation infrastructure. Total emissions in our model can be computed as the sum of the emissions from electric-vehicle users and those from fossil-fuel-based users, specifically emissions  $EM$ ,  $ev$ ,  $ev \in \{ce, ss\}$  are

$$EM_{ev} = A_{ev}^* \alpha_e e_{ev}^* + (1 - A_{ev}^*) \alpha_g e_g^*$$

where  $\alpha_e$  and  $\alpha_g$  are the per-mile emissions from electric and fossil-fuel vehicles,  $\alpha_e < \alpha_g$ . Essentially, there are two factors that contribute to emissions: adoption of electric vehicles (a higher adoption leads to lower emissions), and average miles driven (higher average driving leads to higher emissions). However, as we illustrated in Theorem 4, adoption and driving always go in the same direction, which leads to competing effects with respect to carbon emissions. Let  $\Delta EM = EM_{ss} - EM_{ce}$ , so that a positive  $\Delta EM$  indicates that the switching-station system is worse at reducing carbon emissions than the conventional system. The next theorem examines these conditions.

**Theorem 5.** *When the switching-station system achieves higher (lower) adoption of electric vehicles than the conventional system, it may lead to higher (lower) total carbon emissions if the electric vehicles are not sufficiently less emitting than fossil-fuel vehicles. Formally, despite  $A_{ss}^* > A_{ce}^*$ ,  $\Delta EM > 0$  and despite  $A_{ss}^* < A_{ce}^*$ ,  $\Delta EM < 0$  iff  $\alpha_e > \alpha_{gas} \cdot \lambda$ , where  $\lambda$  is a positive-valued function of the model primitives,  $\lambda = \frac{e_g^*(A_{ss}^* - A_{ce}^*)}{A_{ss}^* e_{ss}^* - A_{ce}^* e_{ce}^*}$ . Furthermore*

1.  $\lambda < 1$  if  $\max(e_{ss}^*, e_{ce}^*) > e_g^*$ .
2. If  $\Gamma = \frac{A_{ss}^* e_{ss}^* - A_{ce}^* e_{ce}^*}{A_{ss}^* - A_{ce}^*}$  is increasing in  $e_{ss}^*$ , then  $\lambda$  is increasing in  $c$  and  $\tau$ , and decreasing in  $c_g$ .
3. If  $A_{ss}^*$  is concave in  $e_{ss}^*$ ,  $\Gamma$  is increasing in  $e_{ss}^*$ .
4. If the motorist has a quadratic utility of driving (i.e.  $u(e) = e\theta - e^2/2$ ) and  $g(\cdot)$  follows a uniform distribution on the interval  $[-a, a]$  with  $a \geq R$ ,  $\Gamma$  increases in  $e_{ss}^*$ .

The above theorem illustrates why the dual policy objectives of reducing oil dependence and carbon emissions may be in conflict. While switching-station systems increase adoption and consequently reduce oil dependence, they also incent higher driving which can lead to increased carbon emissions.

In particular, the adoption-driven benefits that switching-station systems provide over conventional systems may be dominated by their use/driving related disadvantages. This is more likely to happen if the per-mile emissions from electric vehicles are high enough. Following the same logic, switching-station systems can be better for the environment even if they are adopted by fewer people. In our detailed data-driven numerical analysis in Section 5, we highlight vital policy recommendations that derive from this analysis.

The formal statement of the Theorem 5 further characterizes  $\lambda$ , the threshold carbon intensity of electricity production at which the preferred systems for the two objectives are different. A decrease in  $\lambda$  makes the key misalignment between oil-dependence (adoption) and emissions reduction in Theorem 5 more likely. Note that function  $\Gamma$  is the ratio of  $A_{ss}^* e_{ss}^* - A_{ce}^* e_{ce}^*$ , the difference between total expected driving for switching-station systems and conventional electric vehicles, to  $A_{ss}^* - A_{ce}^*$ , the difference in adoption. When the optimal driving  $e_{ss}^*$  increases as a result of a change in any exogenously given primitive in our model, the increase in total expected electric system driving dominates the effect of an increase in adoption; hence the misalignment results in Theorem 5 become more likely. This result holds if the adoption is concave, i.e., it increases in a diminishing way with respect to the optimal driving. More specifically, part 4 illustrates a utility function and a distribution under which the above corollary holds. Consider a change in battery technology that leads to an increase in both adoption and driving (such as a reduction in battery cost or charging time), so that  $\lambda$  decreases. In such a case, the condition  $\alpha_e > \alpha_g \cdot \lambda$  in Theorem 5 becomes more likely to hold, making the electric vehicle system with a higher adoption worse for the environment. If it is the switching-station system that leads to higher adoption, improvements in battery technology can actually hurt the environment!

## 5. SCENARIO ANALYSIS AND IMPLICATIONS

In this section, we calibrate our models with motorist behavior data, electric vehicle technology data, operation costs and emissions data to estimate the relative effectiveness of the two systems under the status quo and other plausible future scenarios. As before, we consider adoption and emissions as our metrics of the two objectives. In addition to status quo parameters, we consider possible future changes in battery technology and the likely evolution of energy prices. The changes in battery cost and performance and changes in prices of fuel, electricity may arise out of a natural evolution of technology, demand, supply, etc. or as a result of direct policy interventions such as subsidies and taxes—our analysis applies irrespective of the source of changes that lead to the examined scenario. Tables 5.1 to 5.6 show our calibrated demand parameters and the method and sources employed to come up with the estimates.

<i>Parameter</i>	<i>Estimated Value</i>	<i>Estimation Method/Sources</i>
Range	$R = 100$ miles	Standard performance of a 24 kWh battery (Better Place (2011b))
Charging Time	$\tau = 1/4$ days	
Battery Cost	$c = \$7.15/\text{day}$	A battery costs \$12500 – \$15000 (we take the average \$13750) and has a lifetime of 8 years (Better Place Blog (2011)). The daily cost is found based on a fixed annuity amount over the lifetime of a battery with an interest rate of 11.3%. As a proxy for the interest rate, we used the weighted average cost of capital (WACC) for Tesla Motors (Paradise et al. (2010)), another electric car company at a similar stage of development as Better Place.

TABLE 5.1. Battery Technology Parameters

<i>Parameter</i>	<i>Estimated Value</i>	<i>Estimation Method/Sources</i>
Cost of Gasoline	$c_g = \text{¢}10.9/\text{mile}$	The retail price of gasoline was \$2.82 per gallon in 2010 (U.S. Energy Information Administration (2011b)). An average passenger car gets 25.8 miles to the gallon based on the U.S. Environmental Protection Agency (EPA) (2010).
Cost of Electricity	$c_e = \text{¢}2.5/\text{mile}$	The U.S. average retail price of electricity for the transportation sector was \$10.42 per kWh in 2010 (U.S. Energy Information Administration (2011a)).

TABLE 5.2. Energy Cost Parameters

<i>Parameter</i>	<i>Estimated Value</i>	<i>Estimation Method/Sources</i>
Gasoline System Emissions	$\alpha_g = 341$ gr/mile	Based on 8,788 grams of $CO_2$ /gallon (U.S. Environmental Protection Agency (EPA) (2005)) and a fuel economy of 25.8 miles/gallon of an average passenger car.
EV Emissions (USA)	$\alpha_e = 138$ gr/mile	Based on 600 grams of $CO_2$ /kWh of electricity generated based on the US electricity mix in 2009 (U.S. Energy Information Administration (2010b)) and a range of 100 miles of a 24 kWh battery. This value is found by dividing total $CO_2$ emissions by total net electricity generation in 2009, the most recent year reported.

TABLE 5.3. Carbon Emission Parameters

**Results.** First, we investigate the relative effectiveness of switching-station and conventional electric vehicle systems based on the parameters of existing technology and known motorist behavior patterns in Tables 5.1–5.6. In the absence of any data on the range-inconvenience penalty,  $M$ , we make no assumptions and present our results for many different values of  $M$ . Given  $c_g = \text{¢}10.9$ , a penalty of  $M = \$1$  is equivalent to a gasoline customer’s total gasoline cost for 9.17 miles of driving. Further, we



<i>Parameter</i>	<i>Estimated Value</i>	<i>Estimation Method/Sources</i>
Utility Function	$u(Y) = \frac{1}{b} \left( \theta Y - \frac{Y^2}{2} \right)$	There is little evidence in the literature for a functional form of the utility function for driving, but based on data a quadratic utility function with a satiation level fits well the consumption of driving miles (see Singh and Vives (1984) and Farahat and Perakis (2010) for a similar use of the quadratic function). Section 6.3 discusses the use of log, square root and power utility functions.
Satiation Level	$\theta = 58.54$ miles	A vast literature on the estimation of gasoline demand (Dahl (1979) and Espey (1998)) has focused on estimating the price elasticity $\epsilon_p$ of gasoline demand by using a log-linear model specification. Brons et al. (2008) estimate the long-run price elasticity of gasoline demand as $\epsilon_p = -0.84$ by using meta-analytical techniques that unify all other studies in the literature. To find the intercept value, we use the mean driving level $e_g^* = 37.14$ miles from the 2001 National Household Travel Survey and a gasoline price of \$1.78 per gallon in 2001. $\theta$ is the average satiation level for motorists and $b$ is a scaling factor that captures the utility from driving. The implied demand function from our utility model fits the demand function from the literature extremely well.
Scaling Factor	$b = 277.74$ miles/\$	

TABLE 5.4. Driving Utility Parameters

<i>Parameter</i>	<i>Estimated Value</i>	<i>Estimation Method/Sources</i>
Distribution	$g() \equiv$ Shifted Gamma	We use the distribution of US motorists' daily driving distances (Hu and Reuscher (2004)) to estimate the distribution. We use the Kolmogorov-Smirnov test to check the fit of various distributions, and we find that the gamma distribution fits total driving distance well (p-value of 0.88). The mean and standard deviation of distribution are calculated as 37.14 and 35.61 miles respectively. This is the distribution of total daily driving distance and includes the customer's decision $e$ as well as the noise term $\epsilon$ . In order to isolate $\epsilon$ from $e$ , we shift the distribution to the left by its mean.
Gamma Shape	$k = 1.0876$	
Gamma Scale	$m = 34.147$	
Gamma Location	$p = 37.14$	

TABLE 5.5. Unpredictable Demand Variability Parameters

perform scenario analysis to identify the relative effectiveness of two business models under multiple plausible scenarios including technological evolution and energy cost evolution.

**5.1. The Impact of Technology Evolution.** Figure 5.1 illustrates the adoptions and emission under different systems for the status quo (middle row) and in two future scenarios that may arise due to improvements in battery technology. The middle row shows the results for the current state of the world with a “high” cost of battery (\$7.15) and a “low” range (100 miles). The top row

<i>Parameter</i>	<i>Estimated Value</i>	<i>Estimation Method/Sources</i>
Switch Availability	$r = 99\%$	Marketing Materials and website of Better Place.
Green Utility–Maximum Willingness to Pay (WTP)	$d = \$5.30 / \text{day}$	Hidrué et al. (2011) estimate the WTP for some EV attributes based on a survey of 3029 respondents. We found how much extra a customer is willing to pay for an EV that more or less mimics a contemporary gasoline system (with a range of 300 miles, a charging time of 10 minutes, etc.), but emits 60% less $CO_2$ than a gasoline car. We came up with an estimate of \$10,192 for the maximum WTP over the system’s 8 years of lifetime. Daily WTP is found based on a fixed annuity amount over the lifetime with an interest rate of 11.3%.

TABLE 5.6. Other Model Parameters

illustrates scenarios with lower battery cost (\$2.86 as projected for 2020 by the Boston Consulting Group (2010)). The bottom row illustrates a scenario with a higher range, 200 miles.

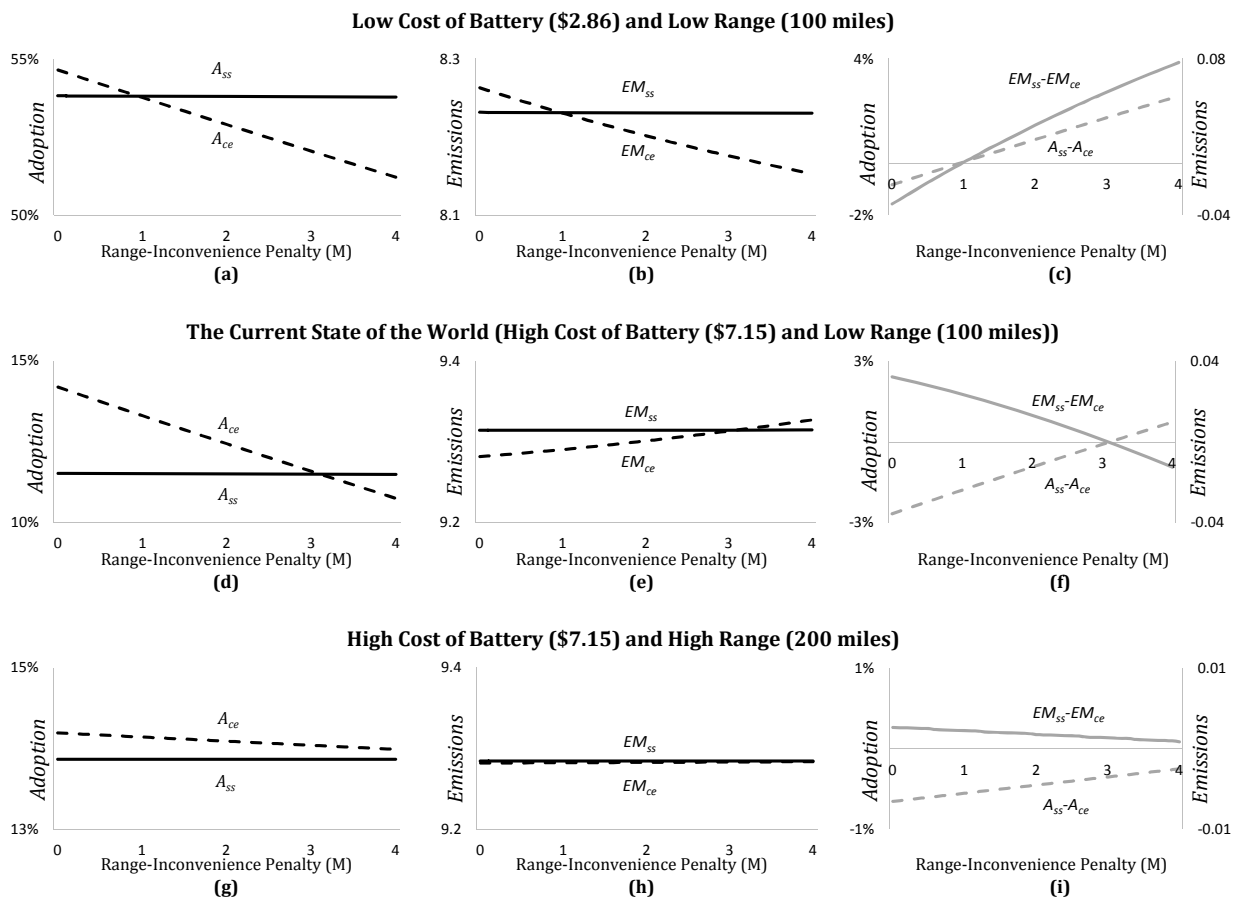

The black lines represent the conventional (dashed) and switching-station models (solid); the gray lines illustrate the differences in emissions (solid) and adoption (dashed). Emissions are in kg of  $CO_2$ .

FIGURE 5.1. The Impact of Technological Evolution on Adoption and Emissions

First, note from Figure 5.1, panels (d) and (e), that the adoption and emissions in the conventional system are more sensitive to the range-inconvenience penalty  $M$  given the current range of 100 miles because the incidence of range inconvenience is much higher in the conventional system. Next note that for high enough range-inconvenience penalties, a switching-station system can lead to higher adoption of EVs, validating that these systems hold substantial promise as their proponents argue.

Comparing panels (a) and (d), we see that the effect of a decrease in battery cost on adoption is substantial both for conventional and switching-station systems. Adoption can increase to as high as 55% (from panel (a)) for both systems, which is almost four times today's maximum adoption value of 14% (from panel (d)). On the other hand, when we look at Figure 5.1 (b) and (e), we see that a decrease in battery cost has a much smaller effect on total emissions— it corresponds to a decrease of about 11% from the current emissions values.

A comparison of panels 5.1 (c) and (f) suggests that switching-station systems become superior to conventional systems in the future in terms of adoption. That is, a reduction in the cost of batteries favors switching-station systems. However, this also leads switching-station system to emit more in the future, which reiterates the central misalignment of objectives, superiority in terms of adoption does not necessarily mean lower emissions. As batteries are expected to become much cheaper in the future, the price premium paid by customers will be much lower, hence usage of switching-station systems will be elevated, leading to higher emissions.

Finally, we see from panel (f) that today the dual policy objectives of increasing EV adoption and reducing carbon emissions are aligned. Switching-station systems are, in fact, preferred for achieving reductions in both oil dependence and emissions. However, based on our model and scenario analysis, we expect that these two goals will not be aligned in the future, if, as expected, battery costs go down (panel (c)). When batteries become cheaper, switching-station systems will become more effective in increasing EV adoption, but this also leads to higher emissions. Note that all of the above effects can arise out of a reduction in battery costs due to technology advancements, but the same effects and misaligned policy objectives will exist if battery costs are reduced due to (misguided) battery price reducing policy interventions such as battery purchase, research or manufacturing subsidies.

Note from Figure 5.1 panels (g) and (h) that an improvement in battery range leads the two systems to become similar both in terms of adoption and emissions. Not surprisingly, if battery range is high enough, range anxiety ceases to be an issue and the switching-station system becomes similar to the conventional system. When we look at Figure 5.1 (d) and (g), we see that the effect of an extension in battery range on adoption is quite limited both for conventional and switching-station systems. It increases adoption up to 2 – 3% maximum, depending on the level of range inconvenience. As

a result of this limited change in adoption, the change in emissions is also quite limited, less than 0.5% from the current emissions values. Note that this and the above analysis imply that battery cost reductions have a much larger impact on adoption and emissions than battery range extension. Finally, note in panel (i) that, as opposed to the battery cost reduction effect, the dual objectives of increasing electric vehicle adoption and reducing greenhouse gas emissions are still aligned when there is an extension in battery range. In other words, there won't be any misalignment in the dual policy objectives; however, the switching-station model does not help increase EV adoption either.

**5.2. The Impact of Changing Energy Costs.** Energy costs vary widely as a results of changes in supply and demand and because of idiosyncratic taxation. In our next set of counter-factual analyses, we investigate how a change in the costs of electricity and gasoline influence the adoption and emissions in our two systems. In Figure 5.2, the middle row shows the current state of the world (as before). The top row illustrates our analysis under a scenario with the long-run cost of gasoline at 50% more than the current long-run value (i.e.,  $\bar{c}_g = \text{¢}16.35$ , which corresponds to  $\sim\text{\$}4.20/\text{gallon}$ ) and the bottom row with the cost of electricity at 50% more than the current value (i.e.,  $\bar{c}_e = \text{¢}3.75$ ). First, note from Figure 5.2 panels (a) and (d) that an increase in the cost of gasoline favors both electric vehicles in terms of adoption, but it favors the switching-station system more. Thus, the expected rise in oil prices in the future (U.S. Energy Information Administration (2010a)) will increase the attractiveness of switching-station systems, which is in line with our results in Theorem 3, a finding that is driven by the economies of scale in the switching-station system. More importantly, comparing panels (b) and (e) shows that the reduction in emissions is quite substantial due to an increase in the cost of gasoline: the decrease is almost 50%, much larger than all other comparisons examined by our study. Based on this analysis, we believe that a policy of gasoline taxes that leads to the above hypothesized increase in gasoline prices is the most effective tool in reducing emissions. The effect of an increase in the cost of electricity is similar to the effect of the cost of gasoline, but in the opposite way. It hurts both systems, but hurts switching-station systems more due to the economies of scale effect. On the other hand, the change in emissions is quite limited as seen in Figure 5.2 (h), suggesting that making electricity cheaper would not be an effective tool for reducing emissions.

**5.3. The Impact of the Electricity Mix.** As Theorem 5 suggests, the ratio of the per-mile emissions advantage of electric vehicles over fossil-fuel systems,  $\alpha_e/\alpha_g$ , is a key parameter that influences the effectiveness of switching-station systems in reducing emissions. This environmental advantage depends crucially on the mix of sources used to produce electricity. Further, the electricity mix is also a key variable that determines whether the dual policy objectives of reducing oil dependence and carbon emissions are aligned. In this section, we investigate the relationship between the electricity

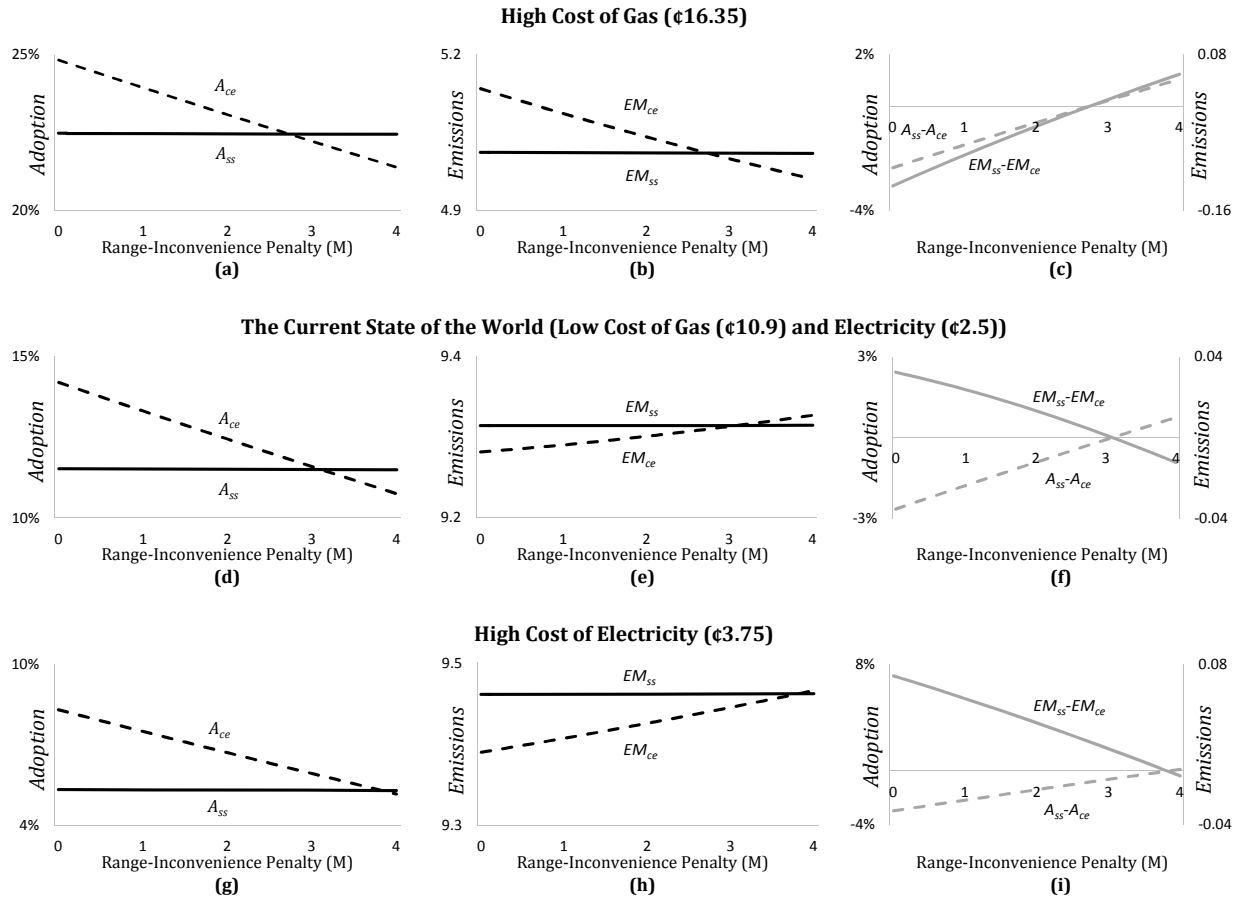

The black lines represent the conventional (dashed) and switching-station models (solid); the gray lines illustrate the differences in emissions (solid) and adoption (dashed). Emissions are in kg of  $CO_2$ .

FIGURE 5.2. The Impact of Energy Cost Evolution on Adoption and Emissions

mix and the policy objective alignment. We compare three different countries with very different electricity mixes. First, we consider France, which has a generation mix that leads to low carbon emissions due to the widespread use of nuclear sources (with  $\alpha_e/\alpha_g = 0.06$ ). Next is the United States, which uses a mix of nuclear, wind and fossil-fuel-based production (with  $\alpha_e/\alpha_g = 0.4$ ). Finally, we consider China, in which the generation mix is dominated by coal, and which is associated with high carbon emissions (with  $\alpha_e/\alpha_g = 0.5$ ).<sup>17</sup> Figure 5.3 shows our results. The top row compares the alignment of dual policy objectives in different countries with the current state of battery technology, and the bottom row shows results in a future scenario in which batteries cost less.

Figure 5.3 panels (a) and (d), show that for an economy like France, there is no misalignment in the policy objectives, with current technology or improved technology– the preferred system for both reducing oil dependence and carbon emissions is the same. In the USA, the objectives are aligned today, but misalignment is expected to happen in the future as a result of battery cost improvements.

<sup>17</sup>We find  $\alpha_e^{FR} = 19.1$  gr/mile and  $\alpha_e^{CH} = 171$  gr/mile based on 83 and 745 grams of  $CO_2$ /kWh of electricity generated, with the 2008 French and Chinese electricity mix (International Energy Agency (IEA) (2010)).

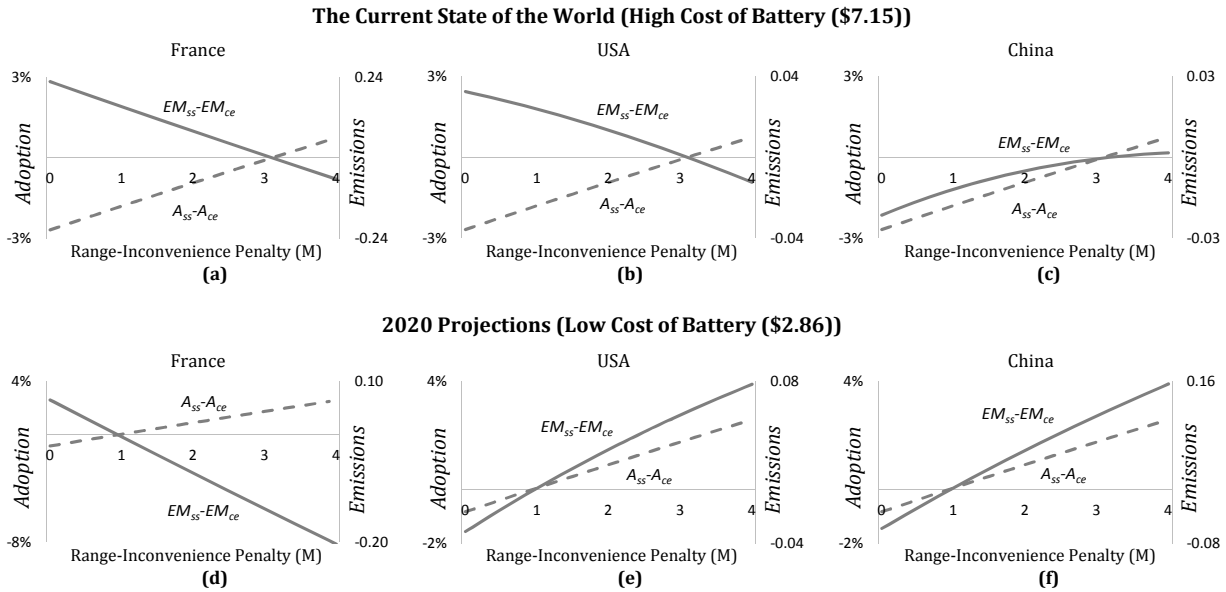

The solid and dashed lines represent the emissions (in kg  $CO_2$ ) and adoption differences respectively

FIGURE 5.3. Emissions in France, USA and China

Note that more recent anecdotal data than that used in this study suggests that battery improvements may arrive sooner than forecast, definitely before a switching-station system can become a reality indicating that even for the USA, a misalignment in policy objectives is highly likely. Finally, in China, the electricity generation mix is highly polluting and the system that is *more* effective in reducing oil dependence is *less* effective in reducing emissions. With status quo parameters, the system that leads to higher adoption is also associated with higher carbon emissions today, an effect that will be exacerbated in the future (panels (c) and (f)), suggesting that switching-station systems come with tradeoffs between the dual policy objectives in these countries.

**5.4. Price Elasticity of Driving.** For many years, researchers and policy makers have sought to understand motorist response to changes in the price of gasoline so as to design effective energy and environmental policy. However, empirical study results differ greatly in their estimates of the price elasticity of driving/gasoline demand. This is hardly surprising, given the spatial and temporal variation between studies, the assumptions inherent in the behavioral model underlying the demand, including measures of quantity, price, income, system ownership, countries included, the specifications of the estimated demand function; and the econometric estimation technique. For example, Espey (1998), using long-run and short-run price elasticity estimates from previous studies, reports that the short-run price elasticity estimates for gasoline demand range from 0 to -1.36, averaging -0.26 and the long-run price elasticity estimates range from 0 to -2.72, averaging -0.58. Given the huge heterogeneity among estimates and the fact that it is a key variable that affects driving level of customers, we

investigate the relationship between the price elasticity and the policy objective alignment in this section. We again compare the USA, France and China by using two different price elasticity values and the projected cost of battery for 2020. In Figure 5.4, the top and bottom rows illustrate our analysis under scenarios with price elasticities of  $-0.26$  and  $-0.58$  respectively, both these levels imply a much lower responsiveness of motorist driving to changes in prices than our original estimates.

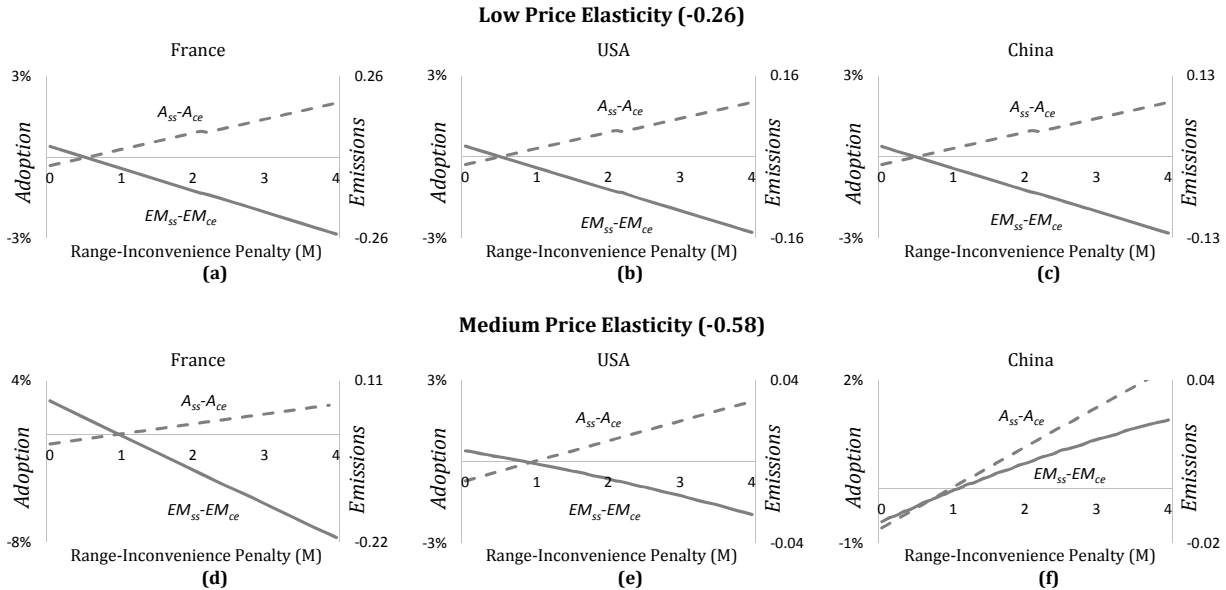

The solid and dashed lines represent the emissions (in kg  $CO_2$ ) and adoption differences respectively

FIGURE 5.4. The Impact of Per-mile Price Elasticity on Emissions in France, USA and China

Figure 5.4 shows that for the French and the U.S. energy mix there is no misalignment in the policy objectives, neither with the low nor with the medium price elasticities. However, in China, increased EV adoption is associated with increased carbon emissions with the medium price elasticity, suggesting that dual policy objectives may not be aligned in countries with a coal-based electricity mix even if price elasticity is much lower than the value used in the original study. Note here that even though a part of our result for the USA changes on the lower range of elasticity estimates, this analysis is predicated on multiple conservative projections of the model parameters. For instance, if battery technology progresses faster than the estimates we use (as seems to be the case based on more recent data), all our results will likely hold even for these low levels of elasticity.

## 6. EXTENSIONS

**6.1. Heterogeneity in Driving Needs.** We have extended our analysis to the case in which motorists differ from each other in their driving needs rather than in their desire for green products. We built a model where motorists have a quadratic utility of driving and their satiation level is distributed along a general distribution  $H$ . Interestingly, while previously motorists with the green

utility above a threshold level adopt electric vehicles, in the new model the adopting population is defined by a range of satiation levels,  $(\theta_1^\nu, \theta_2^\nu)$ ,  $\nu \in \{ce, ss\}$ . Motorists with limited driving needs and satiation levels below  $\theta_1$  derive limited operating cost savings from the lower per-mile costs of EVs. On the other hand motorists with higher driving needs and satiation levels above  $\theta_2$  do not adopt EVs as they have a higher likelihood of driving more than the limited range of EVs, incurring the range-inconvenience penalty. Recall that this penalty is much more severe in the case of conventional electric vehicles, where each time the motorist drives above the range, she incurs the penalty; whereas with the switching-station model the penalty arises in the relatively rare case when the switching station is out of batteries. Thus, for most reasonable parameter values, we find that  $\theta_2^{ss} \geq \theta_2^{ce}$ , i.e., there exists a population of high driving motorists that cannot be captured by conventional electric vehicle systems, but only by switching-station systems. From a practical point of view, our analysis of adoption with heterogeneous driving needs suggests that switching-station systems should target customer segments with high driving needs, such as fleet operators, delivery systems and taxis.

Our analysis confirms that the structural properties identified in Theorems 1-5 hold even if motorists were heterogeneous in their driving needs. Further, in replicating our numerical analysis with heterogeneous customers we confirm all results stated above, we find that the dual policy objectives of reduction in oil dependence and carbon emissions are often misaligned.

**6.2. Green Utility.** There are limited attempts in the literature to measure and model the additional utility that customers derive from using equally performing green products, the green utility in our model. In the absence of any data on the distribution of green utility, we assume that it is distributed uniformly in the interval  $[0, d]$ . By assuming that the green utility is not negative, and on average is positive, we may be inflating the adoption impact of electric vehicles. To address this concern, we have extended our analysis to consider a distribution such that motorists are equally likely to obtain negative or positive utility from a green product, and the average customer obtains zero green utility. Specifically, we assume that  $\tilde{U}_{gr}$  is uniformly distributed in the interval  $[-d, d]$ . This does not lead to any structural change in any of the Theorems. We also find that all qualitative claims from our original scenario analysis in Section 5 continue to hold even with the use of a green utility which has a mean of zero.

**6.3. Additional Discussion.** In addition to the results described above, we conducted a number of additional analyses to verify the robustness of our results. Our original estimates are based on a weighted average cost of capital of 11.3% but are unchanged even with a much lower cost of 5%. We considered a quadratic driving utility function with a satiation level but we replicated the analysis with log, square root and power utility functions. While calibrating the parameters of these



functions, we find that each of them represents a more elastic response to costs of driving than our main assumptions, this accentuates all our effects, resulting in the policy misalignment, and all our other key results become even more likely. Finally, our analysis above relies on estimates of the average carbon intensity of electricity in different countries. There are multiple alternate assumptions possible here. First, some proponents of switching-station systems envision that depleted batteries will only be charged at night, thus using base-load generation capacity, which may be less polluting than the average capacity. By our estimates, restricting battery charging (or repairs in our model) to only the night will significantly increase the number of batteries that will need to be stocked at the station, which will make the system far less promising, perhaps even commercially unviable. Another argument supports using the (much higher) marginal carbon intensity of electricity production because charging electric vehicles is a new demand on the electric grid and as such in most countries it will require using the marginal or peak-load sources of electricity. On balance, we feel that our estimates above using a relatively inelastic utility function and average carbon intensity of electricity are very conservative, and we feel confident that the policy misalignments that we find are quite likely to come to continue.

## 7. DISCUSSION

Our model had the ambitious goal of capturing the salient features of electric system adoption decisions by modeling range anxiety and the impact of different ownership structures (selling miles vs. selling batteries). Although we believe our model captures these two key factors in the electric system adoption decision, naturally, it does so at the expense of other considerations. Clearly, the adoption of electric vehicles is a very complex decision so, in order to focus on key tradeoffs between the two business models we discuss, we had to make a number of simplifications and assumptions. Given that our paper is one of the very few to study this question from a modeling point of view, there is little literature available to guide our efforts, so we had to make some choices. Some of the obvious phenomenon that we omitted include:

- ▷ The adoption process of new technology is clearly dynamic with multiple feedback loops. An analytical model of such a feedback process is analytically intractable (see, e.g., Struben and Sterman (2008) for a systems dynamics approach). Our model considers adoption as a one-time decision, even though it permits the use of non-stationary and correlated distributions describing the driving realizations on different days. On another level, our model can be interpreted as an end-state analysis that helps identify which system is preferred after the model attains high visibility. This allows policy makers to identify which end state is desirable, and then appropriate policies could be introduced to facilitate adoption and diffusion of the system.

- ▷ We chose to focus on the decision to adopt electric vehicles with a gasoline system as a base case. One could envision more complex models in which other green modes of transportation are considered (e.g., public transportation, bicycling). Likewise, one could attempt to model a tripartite competition among gasoline, conventional electric and switching-station systems. Naturally, we would not expect this model to lead to many tractable results. An alternative could be to focus on the high-level adoption decision at the expense of operational details (cf. Chocteau et al. (2010)), which we intend to do in a follow-up paper focused on public policy.
- ▷ Our model is based on a partial equilibrium analysis that considers the differences in the use and adoption of different electric vehicle systems. The use and adoption of electric vehicles may also impact the use of other means of transport not considered in our model, such as air-transport, shipping, etc. The change in the oil-dependence and carbon emissions on account of changes pertaining to other modes of transport are thus excluded from our analysis.
- ▷ There are other potential benefits of electric vehicles due to, for instance, lower maintenance costs (cf. Chocteau et al. (2010)). Moreover, the switching-station model could have an advantage due to battery recycling or reuse by the company which owns the battery or, for instance, due to better battery maintenance by the company rather than by the individual motorists. As long as these and other costs that we do not account for are fixed, they can be easily incorporated into the model with predictable results.
- ▷ Our model concerns a single switching station while, in practice, one expects to see multiple stations covering some geographical area. Studying the issue of locating these stations is a fruitful avenue for future research (see, e.g., Cachon (2011) for research on a related issue) as a function of population density and/or traffic patterns. These issues clearly merit a separate study and, if anything, modeling the network of stations would further increase the economies of scale effect and exacerbate the key misalignment result in our model.
- ▷ It is likely that the government would intervene into any large-scale electric car project by proposing subsidies and tax breaks, along with standards and legal requirements. Similarly, a mobility project on large scale could cause intense competition among electricity providers, car and battery manufacturers and infrastructure builders. Once again, these issues are clearly outside the scope of our paper but, at present, they do not seem to play a major role: e.g., Better Place uses a single type of battery, and cars come from a single manufacturer (Renault-Nissan) without much competition.
- ▷ There are numerous issues related to the electricity supply side which we sidestep in this paper. For instance, batteries at the switching stations can be used to store electricity and give it back to the network at peak demand, or the charging process can be otherwise optimized to take advantage of fluctuating electricity prices. If this is done, we expect to see the switching-station model become

even more attractive. At present, however, it is difficult to estimate the potential impact of such optimization since the business model is not yet tested on the electricity supply side.

Overall, we are confident that the key result of our paper— that there is an overlooked inherent tension between the twin goals of decreasing oil dependence and reducing carbon emissions with the use of a switching-station system— would survive if our analysis were extended to include most of the above proposed additional factors. While we believe that, overall, the switching-station model offers a promising operational solution to the issue of limited electric vehicle adoption (see Girotra and Netessine (2011)) and can be an effective solution to reduce carbon emissions for some countries, we advocate a cautious examination of the effects of such a system based on a rigorous analysis of its operational dynamics.

We urge policy makers to use our analysis in three ways: First, we have identified the preferred system for achieving different objectives under different scenarios. Policy makers should create conditions to support introduction of the system relevant to their setting. Second, policy makers should not conflate the dual objectives of oil dependence and emissions reductions; the preferred system and the policy interventions that further that system may be different for the two objectives, the departure between the two objectives being most severe when switching-station systems are employed, when the energy mix is coal-heavy, and when battery technology advances. Finally, gasoline price increasing policy interventions are most effective for reducing emissions, while subsidies which reduce the total cost of ownership of electric vehicles are best suited for reducing oil dependence.

#### REFERENCES

- Agrawal, V., M. Ferguson, L.B. Toktay, V. Thomas. 2012. Is leasing greener than selling? *Manage. Sci.* **58**(3) 523–533.
- Ambec, S., C. Crampes. 2010. Electricity production with intermittent sources of energy. INRA Working Paper Series.
- Better Place. 2011a. Better Place and Renault launch Fluence Z.E., the first unlimited mileage electric car together with innovative mobility packages, in Europe's first Better Place Center. Accessed Jan. 8, 2012, [goo.gl/42nsc](http://goo.gl/42nsc).
- Better Place. 2011b. Lithium-ion batteries. Accessed Jan. 8, 2012, [goo.gl/vEcz3](http://goo.gl/vEcz3).
- Better Place Blog. 2011. Quicker than quick charge: Extending EV range instantly with battery switch. Accessed Jan. 8, 2012, [goo.gl/G57SH](http://goo.gl/G57SH).
- Boston Consulting Group. 2010. Batteries for electric cars: Challenges, opportunities, and the outlook to 2020. [goo.gl/4rpcV](http://goo.gl/4rpcV).

- Brons, M., P. Nijkamp, E. Pels, P. Rietveld. 2008. A meta-analysis of the price elasticity of gasoline demand. A SUR approach. *Energy Economics* **30**(5) 2105–2122.
- Cachon, G. P. 2011. Supply chain design and the cost of greenhouse gas emissions. Working Paper, The Wharton School, UPenn.
- China Daily July 30. 2012. Fuel-saving targets need driving home. Accessed Mar. 22, 2013, [goo.gl/zzFk9](http://goo.gl/zzFk9).
- Chocteau, V., D. Drake, P. R. Kleindorfer, R. J. Orsato, A. Roset. 2010. Sustainable fleet operations: The role of partnerships and intermediation in electric vehicle adoption. Working Paper, HBS.
- Corbett, C.J., S. Muthulingam. 2007. Adoption of voluntary environmental standards: The role of signaling and intrinsic benefits in the diffusion of the LEED green building standards. Tech. rep., Working Paper, UCLA.
- Dahl, C. A. 1979. Consumer adjustment to a gasoline tax. *The Rev. of Econ. and Stat.* **61** 427–432.
- Denholm, P., W. Short. 2006. An evaluation of utility system impacts and benefits of optimally dispatched plug-in hybrid electric vehicles. Technical Report NREL/TP-620-40293.
- Eberle, U., R. Von Helmolt. 2010. Sustainable transportation based on electric vehicle concepts: A brief overview. *Energy & Environmental Science* **3** 689–699.
- Espey, M. 1998. Gasoline demand revisited: An international meta-analysis of elasticities. *Energy Economics* **20** 273–295.
- Farahat, A., G. Perakis. 2010. A nonnegative extension of the affine demand function and equilibrium analysis for multiproduct price competition. *Oper. Res. Lett.* **38**(4) 280–286.
- Girotra, K., S. Netessine. 2011. How to build risk into your business model. May 2011 Harvard Business Review.
- Girotra, K., S. Netessine, P. Pokala, D. Gupta. 2011. Better Place: The electric vehicle renaissance. Teaching Case, INSEAD.
- Hidrue, M. K., G. R. Parsons, W. Kempton, M. P Gardner. 2011. Willingness to pay for electric vehicles and their attributes. *Res. and En. Econ.* **33** 686–705.
- Hu, P., T. Reuscher. 2004. 2001 national household travel survey, summary of travel trends. *U.S. Dept. of Trans. Fed. Highway Admin.*
- International Energy Agency (IEA). 2010. *CO<sub>2</sub> emissions from fuel combustion highlights*. [goo.gl/imvQ3](http://goo.gl/imvQ3).
- Jevons, W. S. 1866. *The Coal Question*. Second Edition. MacMillan, London.
- Karlin, S., H. Taylor. 1975. *A First Course in Stochastic Processes*. Academic Press, New York.
- Kim, S., M. A. Cohen, S. Netessine. 2007. Performance contracting in after-sales service supply chains. *Manage. Sci.* **53** 1843–1858.

- Kleindorfer, P.R., K. Singhal, L.N. Van Wassenhove. 2005. Sustainable operations management. *Prod. and Oper. Man.* **14**(4) 482–492.
- Kroon, P., M. Weeda, D. Appels. 2012. An international perspective on electric transportation. survey on electric road transport 2012. [goo.gl/TknlC](http://goo.gl/TknlC).
- Lobel, R., G. Perakis. 2011. Consumer choice model for forecasting demand and designing incentives for solar technology. Working Paper, MIT.
- Mak, H.Y., Y. Rong, Z.J.M. Shen. 2013. Infrastructure planning for electric vehicles with battery swapping. *Man. Sci.* .
- Muckstadt, J. A. 2005. *Analysis and Algorithms for Service Parts Supply Chains*. Springer, NY.
- Paradise, J., R. Shanker, S. Srethapramote, T. Radcliff. 2010. Tesla Motors Inc. Another partner, another positive: Panasonic invests \$30MM. Morgan Stanley Research.
- Pistoia, G. 2010. *Electric and hybrid vehicles : Power sources, models, sustainability, infrastructure and the market*. Elsevier, Amsterdam.
- Sherbrooke, C. C. 1968. METRIC: A multi-echelon technique for recoverable item control. *Oper. Res.* **16**(1) 122–141.
- Simpson, A. 2006. Cost-benefit analysis of plug-in hybrid electric vehicle technology. 22nd Intl. Battery, Hybrid and Fuel Cell Electric Vehicle Symp. and Exhib. (EVS-22), Yokohama, Japan.
- Singh, N., X. Vives. 1984. Price and quantity competition in a differentiated duopoly. *Rand J. Econom.* **15**(4) 546–554.
- Sioshansi, R. 2012. Modeling the impacts of electricity tariffs on plug-in hybrid electric vehicle charging, costs, and emissions. *Oper. Res.* **60**(2) 1–11.
- Struben, J., J. Sterman. 2008. Transition challenges for alternative fuel vehicle and transportation systems. *Environment and Planning B: Planning and Design* **35**(6) 1070–1097.
- Timmer, J. 2009. Industrial electrical vehicle stalwarts head out on the road. [goo.gl/cMD8S](http://goo.gl/cMD8S).
- U.S. Department of Energy. 2011. One million electric vehicles by 2015. [goo.gl/iAhmU](http://goo.gl/iAhmU).
- U.S. Energy Information Administration. 2010a. Annual energy outlook 2011 with projections to 2035: Petroleum product prices. [goo.gl/P75xz](http://goo.gl/P75xz).
- U.S. Energy Information Administration. 2010b. Electric power annual: Summary statistics for the United States. [goo.gl/rJ0f5](http://goo.gl/rJ0f5).
- U.S. Energy Information Administration. 2011a. Electric power monthly: Average retail price of electricity to ultimate customers by end-use sector, by state. Accessed Jan. 14, 2011, [goo.gl/M2cBL](http://goo.gl/M2cBL).
- U.S. Energy Information Administration. 2011b. Short-term energy outlook: Regular gasoline retail prices. Accessed Feb. 8, 2011, [goo.gl/6q4ei](http://goo.gl/6q4ei).

- U.S. Environmental Protection Agency (EPA). 2005. Emission facts: Greenhouse gas emissions from a typical passenger vehicle. [goo.gl/3nq39](http://goo.gl/3nq39).
- U.S. Environmental Protection Agency (EPA). 2010. Light-duty automotive technology, carbon dioxide emissions, and fuel economy trends: 1975 through 2010: Appendix D. [goo.gl/jvlJb](http://goo.gl/jvlJb).
- Wolff, R. W. 1982. Poisson arrivals see time averages. *Oper. Res.* **30**(2) 223–231.
- World Energy Council. 2007. Transport technologies and policy scenarios. [goo.gl/buKSc](http://goo.gl/buKSc).

## APPENDIX

## APPENDIX A. PROOFS FOR LEMMAS AND THEOREMS

## A.1. Proof of Lemma 1 (Page 9).

**Analysis of a Conventional Electric Vehicle Customer's Problem.** Customers set their optimal driving best response  $e_{ce}^*$  such that  $e_{ce}^* = \arg \max_e \left[ E[u(e + \epsilon)] - c_e e - M \cdot \bar{G}(R - e) \right]$ . The first-order condition with respect to  $e$  is given below:

$$(A.1) \quad E[u'(e_{ce}^* + \epsilon)] - c_e - M \cdot g(R - e_{ce}^*) = 0.$$

For  $e_{ce}^*$  that solves Eq. A.1 to be a unique optimum, we assume that the following is true:

*Assumption 1:*  $E[u''(e + \epsilon)] + M \cdot g'(R - e) < 0$  for  $\forall e$ .

**Analysis of the Conventional Electric Vehicle Firm's Problem.** The firm solves the maximization problem  $\max_{F_{ce}} \mathbf{E}_{\tilde{U}_{gr}} [I\{U_{ce} > U_g\} \cdot (F_{ce} - c)]$  where  $U_{ce} = E[u(e_{ce}^* + \epsilon)] - c_e e_{ce}^* - M \cdot \bar{G}(R - e_{ce}^*) - F_{ce} + \tilde{U}_{gr}$ . Given  $\mathbf{E}_{\tilde{U}_{gr}} [I\{U_{ce} > U_g\}] = P(\tilde{U}_{gr} > U_g - E[u(e_{ce}^* + \epsilon)] + c_e e_{ce}^* + M \cdot \bar{G}(R - e_{ce}^*) + F_{ce})$  and  $\tilde{U}_{gr} \sim \text{Uniform}[0, d]$ , the first-order condition with respect to  $F_{ce}$  is given below:

$$E[u(e_{ce}^* + \epsilon)] - c_e e_{ce}^* - M \cdot \bar{G}(R - e_{ce}^*) + d - U_g + c - 2F_{ce}^* = 0.$$

$F_{ce}^*$  is the unique optimum, as the second-order condition is  $-2 < 0$ . Given  $F_{ce}^*$ , the fraction of customers who adopt the electric vehicle  $A_{ce}^*$  is given by

$$(A.2) \quad A_{ce}^* = \mathbf{E}_{\tilde{U}_{gr}} [I\{U_{ce} > U_g\}] = \left( E[u(e_{ce}^* + \epsilon)] - c_e e_{ce}^* - M \cdot \bar{G}(R - e_{ce}^*) + d - U_g - c \right) / 2d.$$

Equations A.1 and A.2 characterize Lemma 1.

## A.2. Proof of Lemma 2 (Page 13).

**Analysis of a Switching-Station Vehicle Customer's Problem.** Customers set their optimal driving best response  $e_{ss}$  such that  $e_{ss} = \arg \max_e \left[ E[u(e + \epsilon)] - p_{ss} e - M(1 - r) \cdot \bar{G}(R - e) \right]$ . The first-order condition with respect to  $e$  is given below:

$$(A.3) \quad E[u'(e_{ss} + \epsilon)] - p_{ss} - M(1 - r) \cdot g(R - e_{ss}) = 0.$$

For  $e_{ss}$  that solves Eq. A.3 to be a unique optimum, we need  $E[u''(e_{ss} + \epsilon)] + M(1 - r) \cdot g'(R - e) < 0$  for  $e < R$ . Given *Assumption 1*, this automatically holds.

**Analysis of the Switching-Station Vehicle Firm's Problem.** The firm solves the maximization problem

$$\begin{aligned} \max_{F_{ss}, p_{ss}, Q} \Pi_{ss} &= \mathbf{E}_{\tilde{U}_{gr}} [N A_{ss} (F_{ss} + (p_{ss} - c_e) e_{ss} - c) - cQ] \\ \text{s.t. } Pr(Q > 0) &\geq r \end{aligned}$$

where  $A_{ss} = P\left(\tilde{U}_{gr} > U_g - E[u(e_{ss} + \epsilon)] + p_{ss}e_{ss} + M(1-r) \cdot \bar{G}(R - e_{ss}) + F_{ss}\right)$ . Given that  $O$  is distributed normally with mean and variance  $\tau A_{ss}N \cdot \bar{G}(R - e_{ss})$ , at the optimal driving and adoption levels  $e_{ss}^*$  and  $A_{ss}^*$ ,  $Q^*$  simply solves

$$(A.4) \quad Q^* = \tau A_{ss}^* N \cdot \bar{G}(R - e_{ss}^*) + z_r \left(\tau A_{ss}^* N \cdot \bar{G}(R - e_{ss}^*)\right)^{1/2},$$

where  $\Phi$  is the cdf of the standard normal distribution and  $z_r$  is the standard normal  $z$  value. The first-order conditions with respect to  $F_{ss}$  and  $p_{ss}$  are given below:

$$(A.5) \quad \frac{\partial \Pi_{ss}}{\partial F_{ss}} = \frac{N}{d} \left( E[u(e_{ss}^* + \epsilon)] - 2p_{ss}^* e_{ss}^* + c_e e_{ss}^* - M(1-r) \cdot \bar{G}(R - e_{ss}^*) + c \cdot \bar{G}(R - e_{ss}^*) \cdot \Omega(e_{ss}^*, A_{ss}^*) + d - U_g + c - 2F_{ss}^* \right) = 0,$$

$$(A.6) \quad \frac{\partial \Pi_{ss}}{\partial p_{ss}} = e_{ss}^* \frac{\partial \Pi_{ss}}{\partial F_{ss}} + N A_{ss}^* (p_{ss}^* - c_e - c \cdot g(R - e_{ss}^*) \cdot \Omega(e_{ss}^*, A_{ss}^*)) \frac{\partial e_{ss}}{\partial p_{ss}} = 0,$$

where  $\Omega(e_{ss}^*, A_{ss}^*) = \tau + 1/2\tau z_r \left(\tau N A_{ss}^* \bar{G}(R - e_{ss}^*)\right)^{-1/2}$  and  $\frac{\partial e_{ss}}{\partial p_{ss}} = 1/\left(E[u''(e_{ss}^* + \epsilon)] + M(1-r) \cdot g'(R - e_{ss}^*)\right) < 0$ . Next, we show that there exist unique maximizers  $F_{ss}^*$  and  $p_{ss}^*$  that solve Equations A.5 and A.6. Because  $\frac{\partial \Pi_{ss}}{\partial F_{ss}} = 0$  and  $\frac{\partial e_{ss}}{\partial p_{ss}} < 0$  in Eq. A.6 and defining  $\beta(p_{ss}) = p_{ss} - c_e - c \cdot g(R - e_{ss}) \cdot \Omega(e_{ss}, A_{ss})$ , we need  $\beta(p_{ss}^*) = 0$  at the optimality. Given

$$\frac{\partial \beta}{\partial p_{ss}} = N A_{ss} \left( 1 + c\tau \xi(e_{ss}, A_{ss}) \frac{\partial e_{ss}}{\partial p_{ss}} \right) \frac{\partial e_{ss}}{\partial p_{ss}}$$

with  $\xi(e_{ss}, A_{ss}) = \left( \frac{z_r}{4\bar{G}(x) (\tau A_{ss} N \cdot \bar{G}(x))^{1/2}} g^2(x) + g'(x) \left( 1 + \frac{z_r}{2(\tau A_{ss} N \cdot \bar{G}(x))^{1/2}} \right) \right)$  and  $x = R - e_{ss}$ , the following assumption guarantees that there exists a unique solution  $p_{ss}^*$  that solves  $\beta(p_{ss}^*) = 0$ .

*Assumption 2:*  $\chi(e_{ss}, A_{ss}) = E[u''(e_{ss} + \epsilon)] + M(1-r) \cdot g'(R - e_{ss}) + c\tau \xi(e_{ss}, A_{ss}) < 0$  for  $\forall e_{ss}$  and  $\forall A_{ss}$ .

Under *Assumption 2*, the following equation characterizes the unique solution  $p_{ss}^*$ :

$$(A.7) \quad p_{ss}^* - c_e - c \cdot g(R - e_{ss}^*) \cdot \Omega(e_{ss}^*, A_{ss}^*) = 0.$$

The fact that  $\frac{\partial^3 \Pi_{ss}}{\partial F_{ss}^3} = \frac{N}{d} \left( -\frac{3c\tau z_r \cdot \bar{G}(R - e_{ss})}{8(dA_{ss})^2 (\tau A_{ss} N \cdot \bar{G}(R - e_{ss}))^{1/2}} \right) < 0$  means that the first-order condition  $\frac{\partial \Pi_{ss}}{\partial F_{ss}}$  is concave in  $F_{ss}$ . Therefore there can be at most two solutions that solve  $\frac{\partial \Pi_{ss}}{\partial F_{ss}} = 0$ . Let these solutions be  $F_{ss}^{min}$  and  $F_{ss}^{max}$  with  $F_{ss}^{min} < F_{ss}^{max}$ . As  $\frac{\partial \Pi_{ss}}{\partial F_{ss}}$  is concave in  $F_{ss}$ , we have  $\frac{\partial^2 \Pi_{ss}}{\partial F_{ss}^2} \Big|_{F_{ss}^{min}} > 0$  and  $\frac{\partial^2 \Pi_{ss}}{\partial F_{ss}^2} \Big|_{F_{ss}^{max}} < 0$ . Therefore only  $F_{ss}^{max}$  can be a maximizer, whereas  $F_{ss}^{min}$  is a minimizer. Hence there is a unique maximizer  $F_{ss}^* = F_{ss}^{max}$  that solves Eq. A.5.

For the optimality of  $F_{ss}^*$  and  $p_{ss}^*$ , we also need  $H(F_{ss}^*, p_{ss}^*) = \left[ \frac{\partial^2 \Pi_{ss}}{\partial F_{ss}^2} \frac{\partial^2 \Pi_{ss}}{\partial p_{ss}^2} - \left( \frac{\partial^2 \Pi_{ss}}{\partial F_{ss} \partial p_{ss}} \right)^2 \right] \Big|_{F_{ss}^*, p_{ss}^*}$  to be positive evaluated at  $F_{ss}^*$  and  $p_{ss}^*$ . The following assumption guarantees this:

$$\begin{aligned} \text{Assumption 3 : } H(F_{ss}^*, p_{ss}^*) &= \frac{N}{d} \frac{\partial^2 \Pi_{ss}}{\partial F_{ss}^2} \left( \frac{N}{d} \frac{\partial e_{ss}}{\partial p_{ss}} e_{ss}^* \frac{c\tau z_r \cdot g(R - e_{ss}^*)}{4(\tau A_{ss}^* N \cdot \bar{G}(R - e_{ss}^*))^{1/2}} + \frac{\partial \beta}{\partial p_{ss}} \Big|_{p_{ss}^*} \right) \\ &\quad - \left( \frac{N}{d} \frac{\partial e_{ss}}{\partial p_{ss}} \frac{c\tau z_r \cdot g(R - e_{ss}^*)}{4(\tau A_{ss}^* N \cdot \bar{G}(R - e_{ss}^*))^{1/2}} \right)^2 > 0 \end{aligned}$$



where  $\frac{\partial^2 \Pi_{ss}}{\partial F_{ss}^2} = \frac{N}{d} \left( -2 + \frac{c\tau z_r \cdot \bar{G}(R - e_{ss}^*)}{4dA_{ss}^* (\tau A_{ss}^* N \cdot \bar{G}(R - e_{ss}^*))^{1/2}} \right)$ . Finally, given  $F_{ss}^*$ , the fraction of customers who adopt the electric vehicle  $A_{ss}^*$  solves the following equation:

$$(A.8) \quad A_{ss}^* = \frac{E[u(e_{ss}^* + \epsilon)] - c_e e_{ss}^* - (M(1-r) + c \cdot \Omega(e_{ss}^*, A_{ss}^*)) \bar{G}(R - e_{ss}^*) + d - U_g - c}{2d}.$$

Equations A.3, A.4, A.7 and A.8 characterize Lemma 2.

**A.3. Proof of Theorem 1 (Page 15).** Given  $p_{ss}^*$  defined by A.7, the customer's optimal driving  $e_{ss}^*$  solves

$$(A.9) \quad \Theta_1 = E[u'(e_{ss}^* + \epsilon)] - c_e - (M(1-r) + c \cdot \Omega(e_{ss}^*, A_{ss}^*)) g(R - e_{ss}^*) = 0.$$

Given  $\Theta_1$  and Eq. A.8, the fraction of customers who adopt electric vehicle  $A_{ss}^*$  solves the following equation:

$$(A.10) \quad \Theta_2 = A_{ss}^* - 1/2d \left( \frac{E[u(e_{ss}^* + \epsilon)] - c_e e_{ss}^* - U_g + d - c - \left( E[u'(e_{ss}^* + \epsilon)] - c_e \right) \frac{\bar{G}(x)}{g(x)}}{\epsilon} \right) = 0$$

with  $x = R - e_{ss}^*$ . Then  $e_{ss}^*$  and  $A_{ss}^*$  would be solutions to the simultaneous equations A.9 and A.10. Then using the implicit function theorem, we have

$$\frac{\partial \Theta_2}{\partial A_{ss}^*} \frac{\partial A_{ss}^*}{\partial e_{ss}^*} + \frac{\partial \Theta_2}{\partial e_{ss}^*} = 0 \quad \text{and} \quad \frac{\partial \Theta_1}{\partial e_{ss}^*} \frac{\partial e_{ss}^*}{\partial A_{ss}^*} + \frac{\partial \Theta_1}{\partial A_{ss}^*} = 0.$$

With  $\frac{\partial \Theta_2}{\partial A_{ss}^*} = 1 > 0$  and  $\frac{\partial \Theta_2}{\partial e_{ss}^*} = \frac{\bar{G}(R - e_{ss}^*)}{2dg(R - e_{ss}^*)} \chi(e_{ss}^*, A_{ss}^*) < 0$ , we have  $\frac{\partial A_{ss}^*}{\partial e_{ss}^*} > 0$ . With  $\frac{\partial \Theta_1}{\partial e_{ss}^*} = \chi(e_{ss}^*, A_{ss}^*) < 0$  and  $\frac{\partial \Theta_1}{\partial A_{ss}^*} = \frac{c\tau z_r \cdot g(R - e_{ss}^*)}{4dA_{ss}^* (\tau A_{ss}^* N \cdot \bar{G}(R - e_{ss}^*))^{1/2}} > 0$ , we have  $\frac{\partial e_{ss}^*}{\partial A_{ss}^*} > 0$ . Hence  $e_{ss}^*$  and  $A_{ss}^*$  are strategic complements.

**A.4. Proof of Theorem 2 (Page 17).** 1) The equilibrium profits of a conventional electric vehicle provider and a switching-station vehicle provider are  $\Pi_{ce}^* = NdA_{ce}^{*2}$  and  $\Pi_{ss}^* = NdA_{ss}^{*2} - 1/2cz_r (\tau NA_{ss}^* \bar{G}(R - e_{ss}^*))^{1/2}$  respectively.

Given  $\frac{\partial \Pi_{ce}^*}{\partial c} = \frac{\partial \Pi_{ce}}{\partial c} \Big|_{A_{ce}^*, e_{ce}^*} = -N \mathbf{E} [I \{U_{ce} > U_g\}] \Big|_{A_{ce}^*, e_{ce}^*} = -NA_{ce}^* < 0$  and  $\frac{\partial \Pi_{ss}^*}{\partial c} = \frac{\partial \Pi_{ss}}{\partial c} \Big|_{A_{ss}^*, e_{ss}^*} = -NA_{ss}^* - Q^* < 0$ , we have  $\frac{\partial (\Pi_{ss}^* - \Pi_{ce}^*)}{\partial c} = -N(A_{ss}^* - A_{ce}^*) - Q^*$ . First, note that  $\Pi_{ss}^* > \Pi_{ce}^*$  at  $c = 0$ . Second, when  $\Pi_{ss}^* = \Pi_{ce}^*$ , we must have  $A_{ss}^* > A_{ce}^*$ . Then from Theorem 3, we know that  $A_{ss}^* > A_{ce}^*$  iff  $c < \bar{c}$ . Hence, for  $c < \bar{c}$ ,  $\frac{\partial (\Pi_{ss}^* - \Pi_{ce}^*)}{\partial c} < 0$  and there exists a unique  $\bar{c}_\pi$  such that  $\Pi_{ss}^* = \Pi_{ce}^*$ . At  $c \geq \bar{c}$ ,  $A_{ss}^* \leq A_{ce}^*$ , hence  $\Pi_{ss}^* = \Pi_{ce}^*$  can not hold true. This proves that there exists a unique  $\bar{c}_\pi$  such that  $\Pi_{ss}^* = \Pi_{ce}^*$  and for  $c < \bar{c}_\pi$ , we have  $\Pi_{ss}^* > \Pi_{ce}^*$  and for  $c > \bar{c}_\pi$ , we have  $\Pi_{ss}^* < \Pi_{ce}^*$ . This also proves that  $\bar{c}_\pi < \bar{c}$ .

2) Note that  $\Pi_{ss}/N = A_{ss}(F_{ss} + (p_{ss} - c_e)e_{ss} - c) - cQ/N$  and  $\Pi_{ce}/N = A_{ce}(F_{ce} - c)$ . Then  $\frac{\partial (\Pi_{ss}/N)}{\partial N} = \frac{cz_r (\tau A_{ss}^* N \cdot \bar{G}(R - e_{ss}^*))^{1/2}}{2N^2} > 0$  and  $\frac{\partial (\Pi_{ce}/N)}{\partial N} = \frac{\partial (\Pi_{ce}/N)}{\partial N} \Big|_{A_{ce}^*, e_{ce}^*} = 0$ .

**A.5. Proof of Theorem 3 (Page 17).** Given Eqs. A.1 and A.9 and by defining  $\omega(c) = Mr - c \cdot \Omega(e_{ss}^*, A_{ss}^*) = 0$ , we have  $e_{ce}^* = e_{ss}^*$  iff  $\omega(\bar{c}) = 0$ . The fact that

$$\frac{\partial \omega(c)}{\partial c} = -\Omega(e_{ss}^*, A_{ss}^*) + \frac{c\tau z_r}{4(\tau A_{ss}^* N \cdot \bar{G}(R - e_{ss}^*))^{1/2}} \left( \frac{\partial A_{ss}^*}{\partial c} \frac{1}{A_{ss}^*} + \frac{\partial e_{ss}^*}{\partial c} \frac{g(R - e_{ss}^*)}{\bar{G}(R - e_{ss}^*)} \right) < 0$$

with  $\frac{\partial A_{ss}^*}{\partial c} = \frac{g(x) \cdot \Omega(e_{ss}^*, A_{ss}^*) \frac{\partial \Theta_2}{\partial e_{ss}^*} + \frac{1}{2} \frac{\partial \Theta_1}{\partial e_{ss}^*}}{H(F_{ss}^*, p_{ss}^*)} < 0$  and  $\frac{\partial e_{ss}^*}{\partial c} = \frac{-g(x) \cdot \Omega(e_{ss}^*, A_{ss}^*) - \frac{1}{2} \frac{\partial \Theta_1}{\partial A_{ss}^*}}{H(F_{ss}^*, p_{ss}^*)} < 0$  proves that  $\bar{c}$  is unique.

For the rest of the proof, we use the implicit function theorem  $\frac{\partial \omega(c)}{\partial c} \frac{\partial \bar{c}}{\partial y} + \frac{\partial \omega(c)}{\partial y} = 0$  for  $y = \tau, c_e, N$  and  $c_{gas}$ . Hence given  $\frac{\partial \omega(c)}{\partial c} < 0$ ,  $sign\left(\frac{\partial \bar{c}}{\partial y}\right) = sign\left(\frac{\partial \omega(c)}{\partial y}\right)$ .

**Part a:**

$$\frac{\partial \omega(c)}{\partial \tau} = -c \left(1 + 1/4z_r (\tau N A_{ss}^* \bar{G}(x))^{-1/2}\right) + \frac{c\tau z_r}{4(\tau A_{ss}^* N \cdot \bar{G}(x))^{1/2}} \left(\frac{\partial A_{ss}^*}{\partial \tau} \frac{1}{A_{ss}^*} + \frac{\partial e_{ss}^*}{\partial \tau} \frac{g(x)}{\bar{G}(x)}\right) < 0$$

where  $\frac{\partial e_{ss}^*}{\partial \tau} = \frac{-c \cdot g(R - e_{ss}^*) \cdot \left(1 + 1/4z_r (\tau N A_{ss}^* \bar{G}(x))^{-1/2}\right)}{H(F_{ss}^*, p_{ss}^*)} < 0$  and  $\frac{\partial A_{ss}^*}{\partial \tau} = -\frac{\partial e_{ss}^*}{\partial \tau} \frac{\partial \Theta_2}{\partial e_{ss}^*} < 0$ . Hence  $\frac{\partial \bar{c}}{\partial \tau} < 0$ .

$$\frac{\partial \omega(c)}{\partial c_e} = \frac{c\tau z_r}{4(\tau A_{ss}^* N \cdot \bar{G}(x))^{1/2}} \left(\frac{\partial A_{ss}^*}{\partial c_e} \frac{1}{A_{ss}^*} + \frac{\partial e_{ss}^*}{\partial c_e} \frac{g(x)}{\bar{G}(x)}\right) < 0$$

where  $\frac{\partial e_{ss}^*}{\partial c_e} = \frac{\frac{1}{2} \left(-e_{ss}^* + \frac{\bar{G}(x)}{g(x)}\right) \frac{\partial \Theta_1}{\partial A_{ss}^*} - 1}{H(F_{ss}^*, p_{ss}^*)} < 0$  and  $\frac{\partial A_{ss}^*}{\partial \tau} = \frac{\frac{1}{2} \left(e_{ss}^* \frac{\partial \Theta_1}{\partial e_{ss}^*} - \frac{c\tau z_r \cdot g(x)}{4(\tau A_{ss}^* N \cdot \bar{G}(x))^{1/2}}\right)}{H(F_{ss}^*, p_{ss}^*)} < 0$ . Hence we have  $\frac{\partial \bar{c}}{\partial c_e} < 0$ .

**Part b:**

$$\frac{\partial \omega(c)}{\partial N} = \frac{c\tau z_r}{4(\tau A_{ss}^* N \cdot \bar{G}(x))^{1/2}} \left(\frac{1}{N} + \frac{\partial A_{ss}^*}{\partial N} \frac{1}{A_{ss}^*} + \frac{\partial e_{ss}^*}{\partial N} \frac{g(x)}{\bar{G}(x)}\right) > 0$$

where  $\frac{\partial e_{ss}^*}{\partial N} = \frac{-\frac{\partial \Theta_2}{\partial e_{ss}^*} \left(\frac{c\tau \cdot g(R - e_{ss}^*) \cdot z_r}{4N (\tau A_{ss}^* N \cdot \bar{G}(x))^{1/2}}\right)}{H(F_{ss}^*, p_{ss}^*)} > 0$  and  $\frac{\partial A_{ss}^*}{\partial N} = \frac{c\tau \cdot g(R - e_{ss}^*) \cdot z_r}{4N (\tau A_{ss}^* N \cdot \bar{G}(x))^{1/2}} > 0$ . Hence  $\frac{\partial \bar{c}}{\partial N} > 0$ .

$$\frac{\partial \omega(c)}{\partial c_{gas}} = \frac{c\tau z_r}{4(\tau A_{ss}^* N \cdot \bar{G}(x))^{1/2}} \left(\frac{\partial A_{ss}^*}{\partial c_{gas}} \frac{1}{A_{ss}^*} + \frac{\partial e_{ss}^*}{\partial c_{gas}} \frac{g(x)}{\bar{G}(x)}\right) > 0$$

where  $\frac{\partial e_{ss}^*}{\partial c_{gas}} = \frac{\frac{1}{2} e_{gas}^* \frac{\partial \Theta_1}{\partial A_{ss}^*}}{H(F_{ss}^*, p_{ss}^*)} > 0$  and  $\frac{\partial A_{ss}^*}{\partial c_{gas}} = \frac{-\frac{1}{2} e_{gas}^* \frac{\partial \Theta_1}{\partial e_{ss}^*}}{H(F_{ss}^*, p_{ss}^*)} > 0$ . Hence  $\frac{\partial \bar{c}}{\partial c_{gas}} > 0$ .

**A.6. Proof of Theorem 4 (Page 18).** Let  $e_{ss}^* = e_{ce}^* + t$ . Then using Eqs. A.2 and A.10, we can write

$$\begin{aligned} A_{ss}^* - A_{ce}^* &= \frac{1}{2d} \left( E_{\epsilon} [u(e_{ce}^* + t + \epsilon)] - c_{\epsilon} t - E_{\epsilon} [u(e_{ce}^* + \epsilon)] + M\bar{G}(R - e_{ce}^*) \right. \\ &\quad \left. - \left( E_{\epsilon} [u'(e_{ce}^* + t + \epsilon)] - c_{\epsilon} \right) \frac{\bar{G}(R - e_{ce}^* - t)}{g(R - e_{ce}^* - t)} \right). \end{aligned}$$

Taking the derivative with respect to  $t$ , we have  $\frac{\partial (A_{ss}^* - A_{ce}^*)}{\partial t} = -\frac{\bar{G}(R - e_{ss}^*)}{2dg(R - e_{ss}^*)} \chi(e_{ss}^*, A_{ss}^*) > 0$  under *Assumption 2*.

Given  $A_{ss}^* = A_{ce}^*$  when  $t = 0$  and  $\frac{\partial (A_{ss}^* - A_{ce}^*)}{\partial t} > 0$  imply that  $A_{ss}^* > A_{ce}^*$  if  $e_{ss}^* > e_{ce}^*$  and  $A_{ss}^* < A_{ce}^*$  if  $e_{ss}^* < e_{ce}^*$ .

**A.7. Proof of Theorem 5 (Page 20).** Consider  $\Delta EM = EM_{ss} - EM_{ce} = \alpha_c (A_{ss}^* e_{ss}^* - A_{ce}^* e_{ce}^*) - \alpha_g e_g^* (A_{ss}^* - A_{ce}^*)$ . Then  $\Delta EM < 0$  iff  $\alpha_c < \alpha_g \cdot \lambda$  when  $A_{ss}^* - A_{ce}^* > 0$  and  $\Delta EM < 0$  iff  $\alpha_c > \alpha_g \cdot \lambda$  when  $A_{ss}^* - A_{ce}^* < 0$ .

1.  $\lambda < 1$  iff  $A_{ss}^* (e_{ss}^* - e_g^*) > A_{ce}^* (e_{ce}^* - e_g^*)$  when  $A_{ss}^* - A_{ce}^* > 0$  and  $A_{ss}^* (e_{ss}^* - e_g^*) < A_{ce}^* (e_{ce}^* - e_g^*)$  when  $A_{ss}^* - A_{ce}^* < 0$ .

Given Theorem 4, this holds if  $e_{ss}^* > e_g^*$  when  $A_{ss}^* - A_{ce}^* > 0$  and if  $e_{ce}^* > e_g^*$  when  $A_{ss}^* - A_{ce}^* < 0$ . Hence  $\lambda < 1$  if  $max(e_{ss}^*, e_{ce}^*) > e_g^*$ .

2. Note that  $\lambda = \frac{e_g^*}{\Gamma}$  with  $\Gamma > 0$ . Then  $\frac{\partial \Gamma}{\partial e_{ss}} = \left( \left( A_{ss}^* (A_{ss}^* - A_{ce}^*) - A_{ce}^* (e_{ss}^* - e_{ce}^*) \frac{\partial A_{ss}^*}{\partial e_{ss}} \right) \right) / (A_{ss}^* - A_{ce}^*)^2$ . For an arbitrary parameter  $y$ , we have

$$\frac{\partial \Gamma}{\partial y} = \left( (e_{ss}^* - e_{ce}^*) (A_{ss}^* - A_{ce}^*) \frac{\partial A_{ce}^*}{\partial y} + \frac{\partial e_{ss}^*}{\partial y} \left( A_{ss}^* (A_{ss}^* - A_{ce}^*) - A_{ce}^* (e_{ss}^* - e_{ce}^*) \frac{\partial \Theta_2}{\partial e_{ss}} \right) \right) / (A_{ss}^* - A_{ce}^*)^2.$$

For  $y = c, \tau$ , we have  $\frac{\partial e_{ss}^*}{\partial y} < 0$  and  $\frac{\partial A_{ce}^*}{\partial y} \leq 0$ ; and for  $y = c_g$ , we have  $\frac{\partial e_{ss}^*}{\partial y} > 0$  and  $\frac{\partial A_{ce}^*}{\partial y} \geq 0$ . Also note that  $\frac{\partial A_{ss}^*}{\partial e_{ss}} = \frac{\partial \Theta_2}{\partial e_{ss}}$ . Then if  $\frac{\partial \Gamma}{\partial e_{ss}} > 0$ , for  $y = c, \tau$ , we have  $\frac{\partial \Gamma}{\partial y} < 0$  and for  $y = c_g$ , we have  $\frac{\partial \Gamma}{\partial y} > 0$ . As  $\frac{\partial \lambda}{\partial y} = \frac{\partial e_g^*}{\partial y} \frac{1}{\Gamma} - \frac{\partial \Gamma}{\partial y} \frac{e_g^*}{\Gamma^2}$ , we have  $\frac{\partial \lambda}{\partial y} > 0$  given  $\frac{\partial e_g^*}{\partial y} = 0$  for  $y = c, \tau$  and we have  $\frac{\partial \lambda}{\partial y} < 0$  given  $\frac{\partial e_g^*}{\partial y} < 0$  for  $y = c_g$ .

3. We can rewrite  $\frac{\partial \Gamma}{\partial e_{ss}}$  as  $\frac{\partial \Gamma}{\partial e_{ss}} = \left( (A_{ss}^* - A_{ce}^*)^2 + A_{ce}^* \left( A_{ss}^* - A_{ce}^* - (e_{ss}^* - e_{ce}^*) \frac{\partial A_{ss}^*}{\partial e_{ss}} \right) \right) / (A_{ss}^* - A_{ce}^*)^2$ . If  $A_{ss}^*$  is concave, it satisfies  $A_{ss}^*(e_{ss}^*) - A_{ss}^*(e_{ce}^*) - (e_{ss}^* - e_{ce}^*) \frac{\partial A_{ss}^*}{\partial e_{ss}} \Big|_{e_{ss}^*} > 0$ . As  $A_{ss}^*(e_{ce}^*) = A_{ce}^*(e_{ce}^*)$  from Theorem 4,  $\frac{\partial \Gamma}{\partial e_{ss}} > 0$  if  $A_{ss}^*$  is concave in  $e_{ss}^*$ .

4. Given  $u(e) = \theta e - \frac{e^2}{2}$ ,  $g(x) = \frac{1}{2a}$  and  $\bar{G}(x) = \frac{a-x}{2a}$ , we have  $A_{ce}^* = \frac{1}{2} \left( \frac{e_{ce}^{*2}}{2} - \frac{M(a-R)}{2a} - T \right)$  and  $A_{ss}^* = \frac{1}{2} \left( \frac{(e_{ss}^*)^2}{2} - \left( \frac{M(1-r) + c \cdot \Omega(e_{ss}^*, A_{ss}^*)}{2a} \right) (a-R) - T \right)$  where  $T = \frac{Var(\epsilon)}{2} + U_g + c - d > 0$ . Hence  $A_{ss}^* - A_{ce}^* = \frac{1}{2} (e_{ss}^* - e_{ce}^*) \left( a - R + \frac{e_{ss}^* + e_{ce}^*}{2} \right)$  and  $\frac{\partial A_{ss}^*}{\partial e_{ss}} = \frac{1}{2} (a - R + e_{ss}^*)$ . Then

$$(A_{ss}^* - A_{ce}^*)^2 \frac{\partial \Gamma}{\partial e_{ss}} = \frac{1}{4} (e_{ss}^* - e_{ce}^*)^2 \left( (a-R) \left( a - R + e_{ss}^* + e_{ce}^* + \frac{M}{4a} \right) + \frac{e_{ss}^* (e_{ss}^* + 2e_{ce}^*)}{4} + \frac{T}{2} \right) > 0.$$

Europe Campus  
Boulevard de Constance  
77305 Fontainebleau Cedex, France  
Tel: +33 (0)1 60 72 40 00  
Fax: +33 (0)1 60 74 55 00/01

Asia Campus  
1 Ayer Rajah Avenue, Singapore 138676  
Tel: +65 67 99 53 88  
Fax: +65 67 99 53 99

Abu Dhabi Campus  
Muroor Road - Street No 4  
P.O. Box 48049  
Abu Dhabi, United Arab Emirates  
Tel: +971 2 651 5200  
Fax: +971 2 443 9461

[www.insead.edu](http://www.insead.edu)

**INSEAD**

**The Business School  
for the World®**