



Design of a Tractor for Optimised Safety and Fuel Consumption

Report 104190

Forschungsgesellschaft Kraftfahrwesen mbH Aachen
Body Department

Final Report
Design of a Tractor for Optimised Safety and Fuel Consumption

Project Number

104190

Contractor:

Transport & Environment
Rue d'Edimbourg
1050 Brussels
Belgium

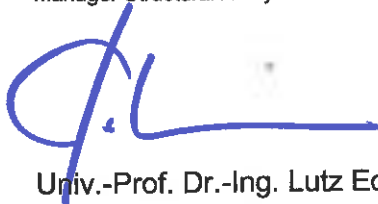
Project Leader:



Dipl.-Ing. Thomas Welfers



Dipl.-Ing. Dipl.-Wirt. Ing. Roland Wohlecker
Manager Structural Analysis and Benchmarking



Univ.-Prof. Dr.-Ing. Lutz Eckstein
Chairman of the Advisory Board

Project Engineers:

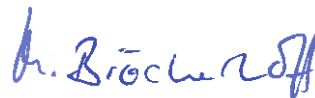
Dipl.-Ing. Sven Ginsberg

Dipl.-Ing. Michael Funcke

Dipl.-Ing. Michael Hamacher

Dipl.-Ing. Ralf Matheis

All rights reserved. No part of this publication may be reproduced and/or published without the previous written consent of fka. © fka



Dr.-Ing. Markus Bröckerhoff
Managing Director fka

Aachen, August 2011

Contents

1	Introduction.....	6
2	Approach.....	7
3	State-of-the-Art Semi-trailer Trucks	9
3.1	Body Shape of Trucks	9
3.2	Body Shape of Trailers	11
3.3	Close to Series Concept Trucks.....	12
3.4	Future Design Concept Trucks	15
3.5	Key Learnings.....	20
4	Standards and Regulations.....	22
4.1	Valid Regulations.....	23
4.1.1	Vehicle Dimensions.....	24
4.1.2	Vehicle Masses	25
4.1.3	Passive Safety	27
4.1.3.1	External Projections	27
4.1.3.2	Pendulum Tests	27
4.1.3.3	Front Underrun Protection Device	28
4.1.3.4	Lateral Protection	28
4.1.4	Towing Devices.....	29
4.1.5	Active Safety	29
4.1.5.1	Direct Vision.....	29
4.1.5.2	Indirect Vision	30
4.1.5.3	Lighting Installation	32
4.2	Future Regulations	34
4.3	Key Learnings.....	36
5	Build-up of CAD Models	38
5.1	Definition of Reference Truck	38
5.2	Optimised Base Concepts	40
6	Safety and Aerodynamic Concepts.....	42

6.1	CFD Simulations.....	42
6.1.1	Aerodynamic Fundamentals.....	42
6.1.2	CFD Simulations of the Reference Truck	46
6.1.3	CFD Simulations of the Optimised Base Concepts.....	49
6.1.4	Selection of Concept for Additional Optimisation	50
6.1.5	Advanced Concept.....	52
6.2	Wind Tunnel Tests.....	56
6.3	Crash Simulations.....	59
6.3.1	Crash Management System	59
6.3.1.1	Definition of Functional Requirements.....	59
6.3.1.2	Concept Design	63
6.3.1.3	ECE-R 93 Test.....	66
6.3.2	Definition of Representative Crash Simulation Setups.....	67
6.3.2.1	HGV Accident Statistics	67
6.3.2.2	Passenger Car Occupant Protection	73
6.3.2.3	VRU Protection	75
6.3.2.4	Self Protection.....	76
6.3.3	Results of Crash Simulations	78
6.3.3.1	Comparison of Partner Protection Performance	78
6.3.3.2	Comparison of VRU Protection Performance	84
6.3.3.3	Comparison of Self Protection Performance.....	85
7	Technical Assessment.....	89
7.1	Estimation of the Impact on Fatality Numbers in Europe.....	93
7.2	Weight Investigation	95
7.3	Evaluation.....	98
8	Environmental and Economic Assessment	100
8.1	Cost Estimation	103
8.2	Evaluation.....	111
9	Recommendations.....	113
9.1	Design Space	113

9.2	Material Usage	115
9.3	Direct Vision	115
10	Summary and Outlook	116
11	Formula Symbols and Indices.....	118
12	Literature	119
13	Appendix	130
13.1	CFD Simulations.....	130
13.2	Partner Protection Simulations	131
13.3	Frontal Collision without Offset	131
13.4	Rear Shunt	134
13.4.1	VRU Protection Simulations.....	138
13.4.2	Reference Tractor: Central Impact.....	138
13.4.3	Reference Tractor: Edge Impact	141
13.4.4	Advanced Concept: Central Impact	143
13.4.5	Advanced Concept: Edge Impact.....	146

1 Introduction

Current trucks are designed to carry a maximum of payload or a maximum volume of goods. In European Union Regulations, the maximum weight and dimensions of trucks are clearly restricted limiting the flexibility that is needed for safety or aerodynamic issues.

This study will analyse the benefits in terms of safety and CO₂ emissions that would result from an increase in the maximum semi-trailer tractor combination length (i. e. 40 t-HGV of currently 16.5 m) without changing the maximum load length. Furthermore, the dimensions, layout and design of such an optimised tractor will be determined. Simulations, calculations and illustrations will support the achieved solution and recommendations will be derived.

The focus of the research project is to show the impact of a possible change in legislation regarding the cabin length. The task is to develop an integrated cabin concept which is focused on maximising environmental performance through aerodynamic streamlining and optimising safety compared to an appropriate reference cabin. Utility and total cost of ownership aspects set important boundaries. With regard to the internal consistence of the project, the definition of both cabins including material use will be based around consumer preferences. This approach guarantees comparability.

In the course of the safety optimisation and with regard to utility implications such as payload requirements, the new cabin's front structure properties will be designed to optimise impact energy absorption and simultaneously ensure a payload that reflects customer's requirements. If the larger cabin is found to be heavier than the reference cabin, the report will provide additional general lightweight design strategies for trucks to compensate.

In contrast to the APROSYS-project, which is described below in chapter 2.1, a significant advantage in aerodynamic performance at a reasonable cabin length increase is one major task of the study. As a starting point of the optimisations, the generic reference 40 t-HGV will undergo aerodynamic optimisation. The most promising aerodynamic concepts will be set-up in safety simulations, in which optimised passive and active safety performance will be assessed and proven. In the course of the safety optimisation process the fully developed deflecting front shape of the APROSYS-project will serve as a valuable basis. The experiences can be used for the design of an aerodynamic and at the same time safer front structure.

The final objective of the project is the concept development of a tractor unit for a 40 t-HGV which is optimised for both safety performance and fuel consumption related to aerodynamics making use of a variable tractor unit length without substantial increase of the empty vehicle weight. The new tractor design will be assessed in a simulation environment and also realised in a 1:18 hardware model for demonstration. The overall aim is to find out how much length increase will prove to be the optimum for the best safety and environmental performance and to create a basis to quantify fuel saving, emission reduction, reduction of fatalities and serious injuries. Also the economic impacts will be analysed.

2 Approach

The first step is an overview of the state of the art concerning the body shape of trucks carried out in chapter 3. This also includes the description of close to series and future concept trucks. In addition, the most relevant valid and future regulations are described. On these conditions a generic reference truck has to be defined in chapter 5.

As a starting point of the optimisations in chapter 6 the generic reference 40 t-HGV undergoes an aerodynamic optimisation. The most promising aerodynamic concepts is set-up in safety simulations in which optimised passive and active safety performance is assessed and proven. In the course of the safety optimisation, and with regard to utility implications such as payload requirements, the new front structure of the truck is designed to optimise impact energy absorption and simultaneously ensure a payload that reflects customer's requirements. To evaluate the self-protection characteristics of the truck, it is crashed against a semi-trailer block in finite elements (FE) simulation. The partner protection characteristics are evaluated by the FE simulation of truck against passenger car (compatibility) and VRU (vulnerable road users) protection simulations. In addition, the active safety characteristics are evaluated concerning direct and indirect vision.

The detailed technical assessment of the optimised front structure is described in chapter 7 of the final report. Therefore the most relevant evaluation parameters are identified at first. Afterwards, a new concept is evaluated for technical aspects. Analogous to that, the environmental and economic impacts are analysed in chapter 8. Reduction of fuel consumption, utility and total cost of ownership aspects set important boundaries. With regard to the internal consistence of this study, the definition of both cabins including material usage is based around consumer preferences. The results from aerodynamic simulation are validated with wind tunnel tests in chapter 6.2.

A guideline for new development activities of the industry to introduce an optimised front structure is given in the recommendations of chapter 9. This includes a detailed summary of the effects on passive safety and fuel consumption as well as a priority list for changes of current EU legal standards for cabin lengths. Also the influence on direct and indirect vision is regarded.

The study concludes the results with a summary highlighting the main steps and giving an outlook for possible future developments and further research potential. An overview of the work packages of this study is shown in Fig. 2-1.

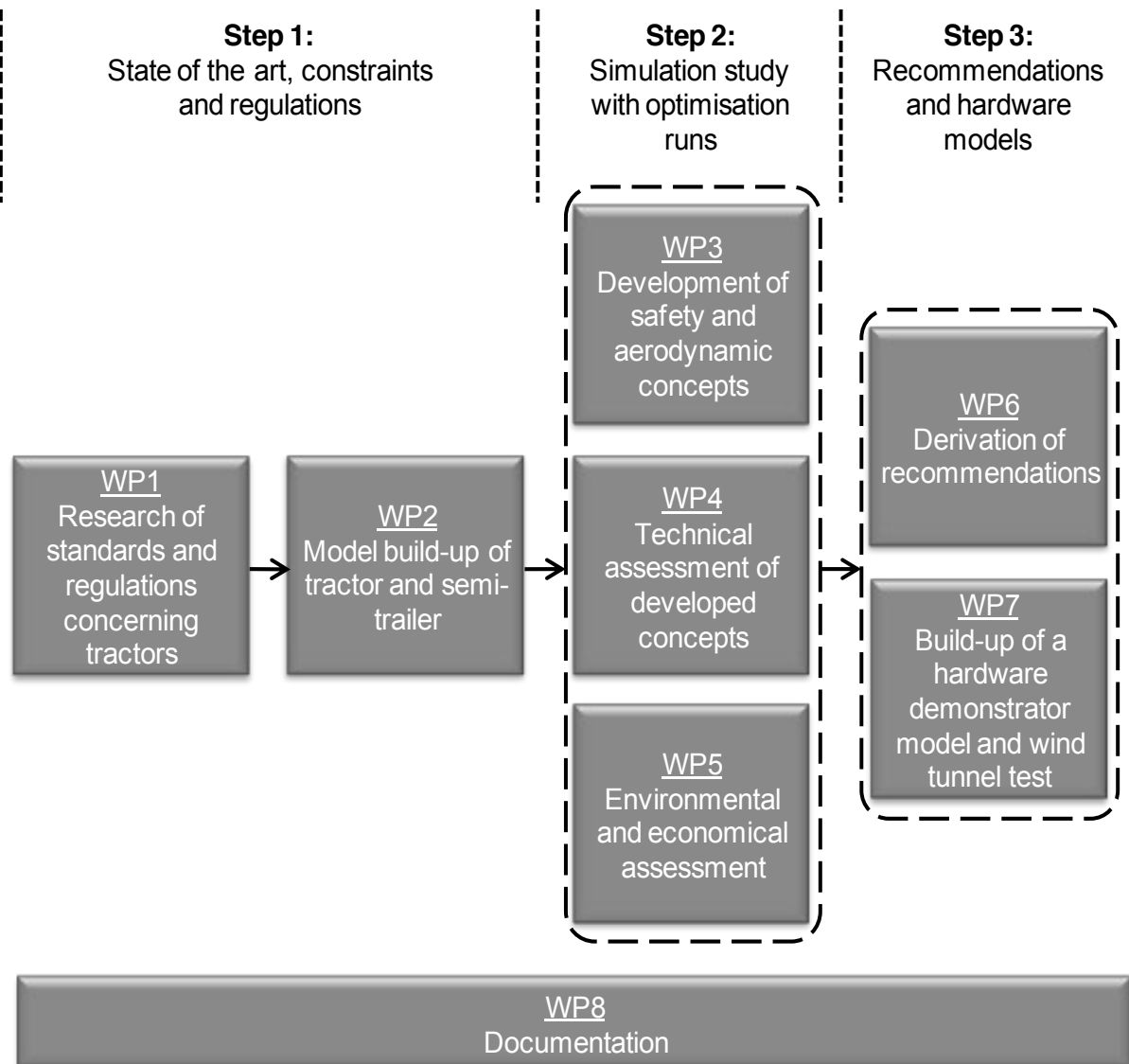


Fig. 2-1: Workflow of the study

3 State-of-the-Art Semi-trailer Trucks

In this chapter the general function of current body shapes for semi-trailer tractors is described. Afterwards an overview of series and close to series concepts is given. Finally future design concepts are described.

3.1 Body Shape of Trucks

The backbone of a tractor is the frame (Fig. 3-1). All other components, e.g. the cabin, drivetrain, wheels, suspension, steering system and brakes are attached to the frame. The cabin is constructed as a self-supporting unibody and should ensure sufficient survival space for passengers. The cabin support absorbs energy in case of a crash. Especially semi-trailer tractors have a high static load (F_{stat}) on their frame. This requires a complex balance between stability, stiffness and mass. [BAC09, SCA10]

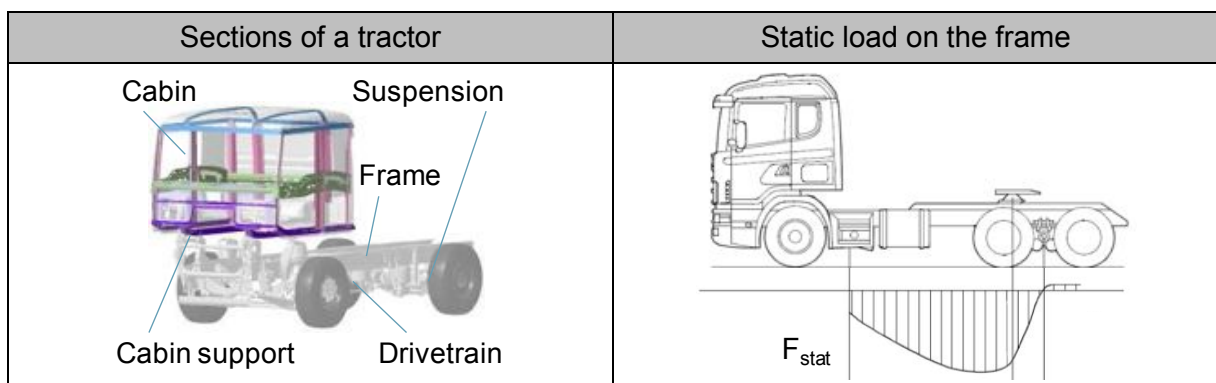


Fig. 3-1: Body shape of a tractor [BAC09, SCA10]

A large quantity of different requirements by the hauling companies result in a high flexibility of the equipment of a tractor. This can be shown by the examples of the cabins in Fig. 3-2. Most manufacturers offer a large range of different cabins. The height of the cabin can be varied as well as the depth [DAF10, IVE07a, MAN09, DAI10a, REN10, SCA10, VOL10a].

Another vehicle that can be used as semi-trailer tractor for local distribution service is the Mercedes-Benz Econic shown in Fig. 3-3. The cabin is made of an aluminium Spacecage[®] covered by sheet moulding compound (SMC). Due to this the manufacturer claims a mass reduction of the Econic cabin by 25 %. In addition two cabin heights are available and the tractor shown in Fig. 3-4 is also available with natural-gas engine. Particularly advantageous are the large side- and windscreens that enable a good visibility for the driver [DAI10b].

However, for long-distance transport this concept shows disadvantages. Because of the package layout only small engines are available. The most powerful available engine for the Mercedes-Benz Econic tractor version, for example, has 205 kW [DAI10b]. Regular long haul vehicles come with engine power between 300 and 540 kW. Furthermore low-floor concepts do not provide a hydraulic cabin support. Hence disadvantages regarding driving comfort must be expected.







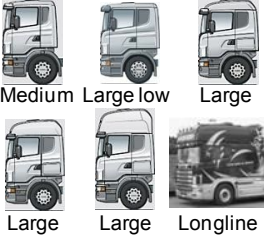



DAF XF	Iveco Stralis	MAN TGX	MB Actros
 <p>Space Cabin Super Space Cabin</p>	 <p>Active Day Active Time Active Time</p> <p>Active Space³</p>	 <p>XL XLX XXL</p>	 <p>S M</p>  <p>L, L low, L high Megaspace</p>
Renault Magnum	Scania R-series	Volvo FH	Volvo FH 16
	 <p>Medium Large low Large</p> <p>Large high Large extra high Longline</p>	 <p>Medium Medium high</p>  <p>Large Large high</p>	 <p>Large Large high</p>

Fig. 3-2: Heavy duty truck cabs [IVE07a, MAN09, DAI10a, REN10, SCA10, VOL10a]




Spacecage [®]	Cabin types
	
Visibility	
	

Fig. 3-3: Mercedes-Benz Econic [DAI10b]



Fig. 3-4: Tractor version of Mercedes-Benz Econic [DAI10b]

3.2 Body Shape of Trailers

Conventional HGV semi-trailers are available with one, two or three axles. The most common semi-trailer is a three axle semi-trailer as shown in Fig. 3-5. These trailers are available as board wall or as curtainsider. In general no special aerodynamic claddings are used.



Fig. 3-5: Trailer concepts [HOC10, KRO09]

Optimisation potential to reduce the fuel consumption of the complete truck does not only exist in tractor design, but also in trailer design. A common technology is the application of side fairings such as it is the case of the Krone Eco Liner. An accordingly equipped articulated truck can have 5 % to 7 % lower fuel consumption because of reduced aerodynamic drag [KRO09].

The UK trailer manufacturer Don-Bur offers an aerodynamically optimised trailer with a curved roof, known as the “Teardrop Trailer”. First generation models were designed to circulate on the domestic market exclusively which allowed for maximum heights strongly exceeding four metres. Don Bur claims significantly reduced aerodynamic drag resulting in important fuel economy improvements [DON10]. Recently Don Bur introduced a four metres model designed for circulation on Continental European roads. The aerodynamic concept of this trailer is compared with a UK standard trailer (4.2 m height) in Fig. 3-6.

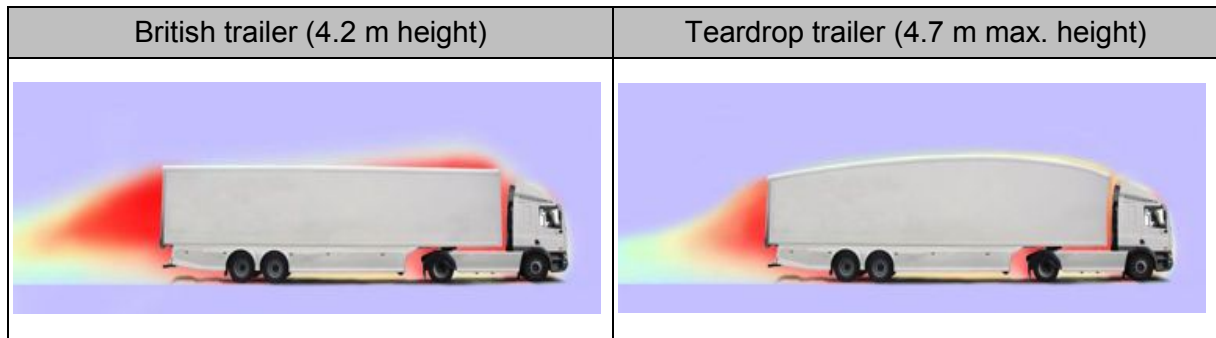


Fig. 3-6: Comparison of British trailer with Teardrop Trailer [DON10]

A similar concept to the Teardrop Trailer is the Cheetah from Cartwright. Through the consequent application of aerodynamic covers, a curved roof and an open rear chassis, the manufacturer claims that fuel savings of 16 to 18 % are possible (Fig. 3-7) [CAR10]. Another example meeting legal dimensions for unlimited circulation within the EU territory is shown by the so called 2WIN[®] trailers manufactured by the Dutch manufacturer Van Eck as well as other according trailers from niche manufacturers Langenfeld and Spermann. The trailer design contains two decks with a free loading height of 1.83 m. It is targeted to customers that transport relatively light weight unstackable pallets with a height between 1.25 m and 1.80 m with regular matching return loads. The second deck increases the loading area more than 50 % from 33 to over 50 Euro-pallets [EMO10].



Fig. 3-7: Cartwright Cheetah and 2WIN[®] trailer [CAR10, EMO10]

3.3 Close to Series Concept Trucks

One close to series concept is the prototype for the next generation of the Mercedes-Benz Actros. First pilot production tractors are already tested on public roads. The tractor is expected to have a new arrangement of daytime running lights, an intensive usage of alternative powertrains and will be offered on market in 2011 [VER09]. Pictures of the first prototypes show that the tractor has optimised aerodynamics, but no fundamental changes in design.



Fig. 3-8: Next generation of the Mercedes-Benz Actros [MOT11]

The concept truck of the Renault named Radiance was presented in 2004. It is illustrated in Fig. 3-9. Numerous cameras mounted on aerodynamic supports allow visibility all around the driving position. A steer-by-wire system without steering column improves crash performance. The usage of active curve light further improves safety. The vehicle has already been tested on public roads as well [LAS04].



Fig. 3-9: Renault Radiance [LAS04]

A very detailed optimisation of a conventional truck is realised in the Iveco Transport Concept shown in Fig. 3-10. Beneath optimised aerodynamics of the tractor, the vehicle has a higher ground clearance and uses tires with a low rolling resistance. The trailer is the Koegel Big-MAXX that is 1.3 m longer than a conventional semi-trailer. This increases the load capacity and requires an exception permit for usage on public roads. The inflatable fins on the cabin rear panel and rear end covering of the trailer reduce turbulences and improve the aerodynamic drag. An additional improvement of aerodynamics is realised by underbody covers. The manufacturer claims a fuel saving of 15 % in comparison to a conventional Iveco Stralis truck resulting from all measures.



Fig. 3-10: Iveco Transport Concept [IVE07b]

A similar concept is realised by the Renault Optifuel Solution Generation 2010 concept. It can be seen in Fig. 3-11. The truck is able to move 25 t of payload and consumes about 5 l less fuel per 100 km. So the diesel consumption is reduced by 15 % as compared to a conventional truck. The improved aerodynamics involves a front wraparound bumper that is 30 cm longer than in a conventional truck. The rearview mirrors are removed by a camera-based rearview system. The streamlined roof is raised to 4.16 m, so that it functions as a deflector. The side fairing, underbody covering and 70 cm deflectors in the rear further improve aerodynamics. In total 1 m is added to the overall vehicle length, leaving the payload volume and mass unchanged [REN08].

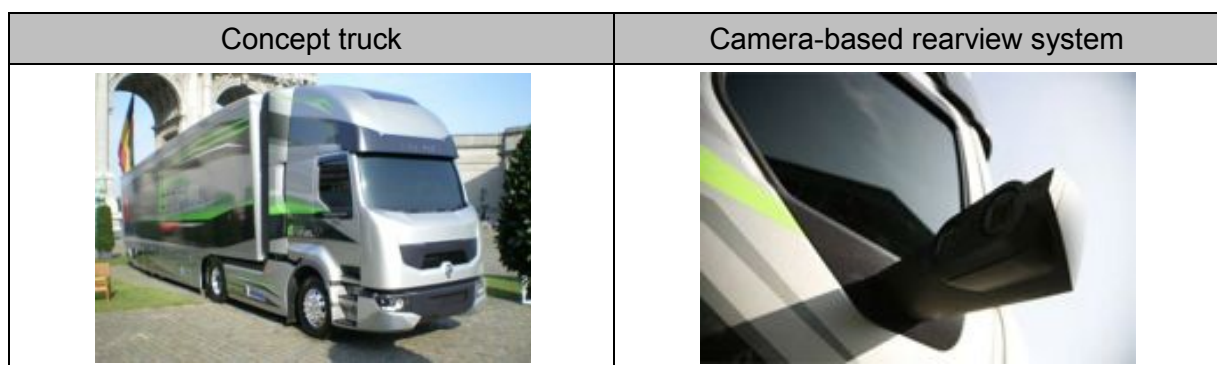


Fig. 3-11: Renault Optifuel Solution Generation 2010 concept [REN08]

Due to stronger future regulations regarding fuel consumption and CO₂-emissions and rising requirements of customers, innovations in truck design will be necessary. One approach to meet such requirements is to lower the truck's weight. Volvo, for example, is developing a "Super Light Heavy Truck" concept. Within this concept the manufacturer wants to achieve a

mass reduction of cabin and frame by 20 % in 10 years. The super-light cabin is designed in FE simulation, using steel with reduced sheet thickness, aluminium and carbon fibre reinforced plastics. The reduction of the total weight is realised without affecting other key characteristics (e.g. crashworthiness or the ability to bear loads). The truck has the same load capacity, but is powered by a smaller engine. To improve the sustainability, renewable fuels or hybrid solutions are realised in which the diesel engine is jointly powering the electric motor [VOL10b, HAR10].



Fig. 3-12: Cabin of the “Super Light Heavy Truck” [VOL10b]

3.4 Future Design Concept Trucks

The EC funded integrated project **Advanced PROtection SYStems** “APROSYS” is one of the most important projects for this study because it is intended to start this project based on these results. In the APROSYS project a safety concept for commercial vehicles which is able to deflect a vulnerable road user (VRU: pedestrians and cyclists) sideways in case of an accident by using the impact impulse was developed. The achieved deflection reduces the risk of a run over. A tapered truck front has been designed and analysed that allows additional deformation space for frontal collisions. Such a front shape can be realised by an add-on structure mountable to the front or by a fully integrated concept as shown in Fig. 3-13. In this project the integrated concept will be scaled to a 40 t-HGV truck.

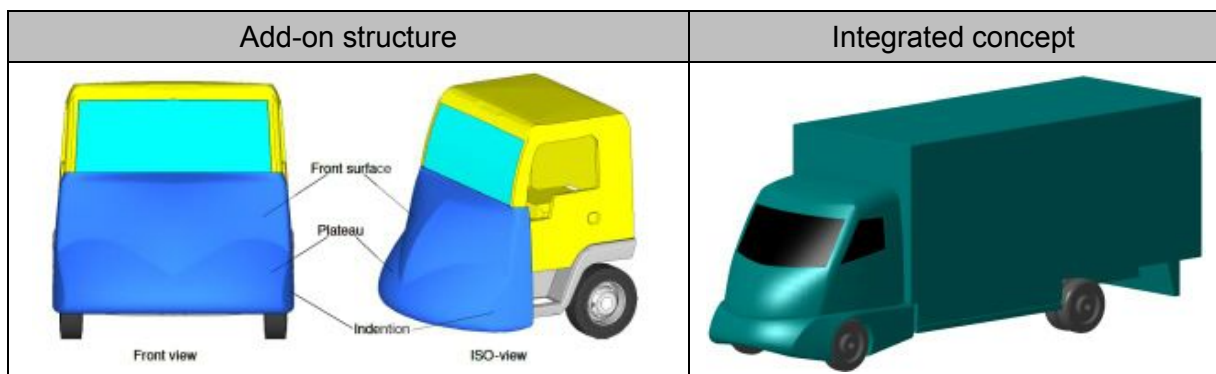


Fig. 3-13: Concepts of the APROSYS project [FAS08]

During the development phase of the new front structure in APROSYS a large number of design versions were generated and assessed. The resulting final principal shape was compared to the basic truck in various numerical simulations with different accident scenarios, pedestrian models and parameter settings. Due to the deflection principle, which is used in the rounded front design for the weakest traffic participants, the structure underneath can be designed mainly for protecting the heavy vehicle's occupants and integrating partner protection relating to passenger vehicles (improved compatibility). The deflection is not only a solution for the protection of pedestrians, but also reduces the impact energy introduced into the heavy vehicle and the passenger car in a HGV-to-car-accident.

Such a convex truck front can significantly reduce the risk of a run over for VRU and also deflect passenger cars. In addition, it provides a crush zone for energy absorption. The enhanced passive safety could be shown in avoiding serious rollover accidents by 87.5 % of the simulated cases in APROSYS [FAS08].

Another concept truck shown in Fig. 3-14 was presented at the IAA Commercial Vehicles 2002 in Hannover. The Aero Safety Truck is a semi-trailer tractor for long-distance transport. The concept was developed in the innovation and design centre of the vehicle manufacturer Hymer. The improved aerodynamics lead to a reduction in fuel consumption of up to 3 l/100 km. An improvement of safety is realised by an extremely stiff safety cage [LAS03, HYM02].



Fig. 3-14: Aero Safety Truck [LAS03, HYM02]

The DAF Xtreme Future Concept (XFC), which can be seen in Fig. 3-15, was presented at the IAA Commercial Vehicles in 2002. The improved aerodynamic concept reduces fuel consumption and the danger of overrunning other road users by a deflecting frontend. The cabin is designed to be based on an aluminium space frame [EAA02].



Fig. 3-15: DAF XFC [EAA02]

The Scania Concept illustrated in Fig. 3-16, was also presented on the IAA Commercial Vehicles in 2002 as a bonnet truck concept for the future. The targets are to identify the market interest for this concept and to optimise aerodynamics. In 2003 an additional concept was presented with the Scania Crash Zone Concept. It has an added structure of 600 mm at the front that absorbs more energy than that of a conventional truck. Therefore the survivable collision speed rises from 56 to 90 km/h. It has potential to reduce the number of fatalities in car to truck collisions. The extra weight for nose concept amounts to 250 kg [SCA02, HAH03].

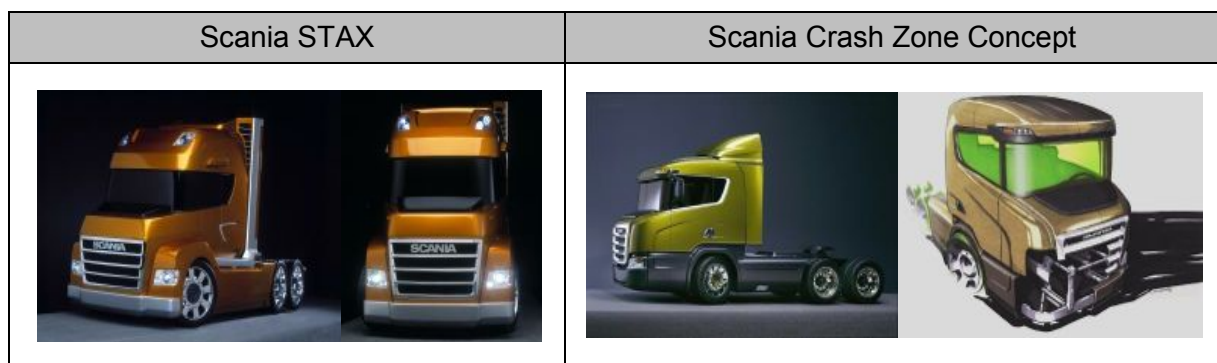


Fig. 3-16: Concept trucks by Scania [SCA02, HAH03]

In 2005 a demonstrator of the Colani Space Truck shown in Fig. 3-17 was presented. The basis of this tractor is a Mercedes-Benz Actros. It is optimised for the usage with a silo semi-trailer. With a c_D value of 0.38 a reduction of fuel consumption of 30 % in comparison to its reference is possible [NEW08].



Fig. 3-17: Colani Space Truck [NEW08]

Volvo presented the Volvo BeeVan Concept illustrated in Fig. 3-18 on the International Auto Show in Detroit 2007. It is a concept for a heavy duty truck for the US market and took part in the Michelin Challenge Design contest. The driver's seat is in the centre of the cabin to realise a full 180° visibility. Blind spot camera technology, lane tracking, parking sensors and driver drowsiness sensors improve the active safety. The doors are slider operated and hidden steps slide out automatically [AUT07].



Fig. 3-18: Volvo BeeVan Concept [AUT07]

In 2008 MAN presented the Bionic Truck with the body form of a dolphin shown in Fig. 3-19. The design of the truck leads to a reduction of fuel consumption up to 25 % according to the manufacturer's declaration. Therefore the cabin needs to be lengthened by 70 cm and the trailer by about 50 cm. So over all, the truck is 1.2 m longer than a conventional truck. Furthermore comprehensive design changes are carried out at the tractor and at the trailer. The trailer has a much rounder front shape. The trailer has a tear drop shape with a tapered rear part and its wheels are covered. For these reasons the truck has a c_D value of 0.29 [SCH08]. A further development of this study is the Concept S, which was exposed at the IAA in 2010 as a hardware demonstrator as shown in the right image.



Fig. 3-19: MAN Bionic Truck and Concept S [SCH08]

The Scania Truck Concept shown in Fig. 3-20 was presented in 2009. It uses a hybrid electric diesel drivetrain and has an ergonomic interior to provide a clean and liveable space for the driver. The high-tech fenders show the duration the truck is travelling on the road as information to other road users. Fig. 3-21 clarifies this. The optimised aerodynamics reduce fuel consumption [PAL09].



Fig. 3-20: Scania Truck Concept [PAL09]





Green lights	Green and red lights
 <p data-bbox="528 1261 772 1290">Driving for 7 hours in 24 hour period Driving 4 hours since last 45 minute break</p>	 <p data-bbox="1150 1245 1362 1290">Driving for 7 hours in 24h period But has been driving for longer than 4.5 hour legislation without a break</p>
<p data-bbox="264 1312 799 1375">Driving < 7 h in a 24 h period and driving < 4 h since last 45 min break</p>	<p data-bbox="863 1312 1414 1375">Driving < 7 h in a 24 h period, but driving > 4.5 h since last 45 min break</p>
Red lights	Flashing red lights
 <p data-bbox="587 1675 762 1704">Driving for longer than 9 hours within a 24 hour period</p>	
<p data-bbox="288 1749 775 1787">Driving longer than 9 h in 24 h period</p>	<p data-bbox="927 1733 1353 1796">Truck travelling faster than allowed on this kind of road</p>

Fig. 3-21: Fenders of the Scania Truck Concept [PAL09]

Recently Magna presented the Eco Truck shown in Fig. 3-22 with an aerodynamic design and a lightweight heavy truck frame. The tractor is using a frame in “Monocoque Design” and is designed for the European market. By the usage of welded sheet metal and a casted

frame head, a weight reduction of 290 kg (34 %) in comparison to a conventional frame has been realised. Beneath a good space utilisation by the integration of components (e.g. tank) in the frame, the design qualifies the tractor for the usage of alternative drivetrains. In addition it is suitable for future safety requirements and has a high stiffness [WIN10].

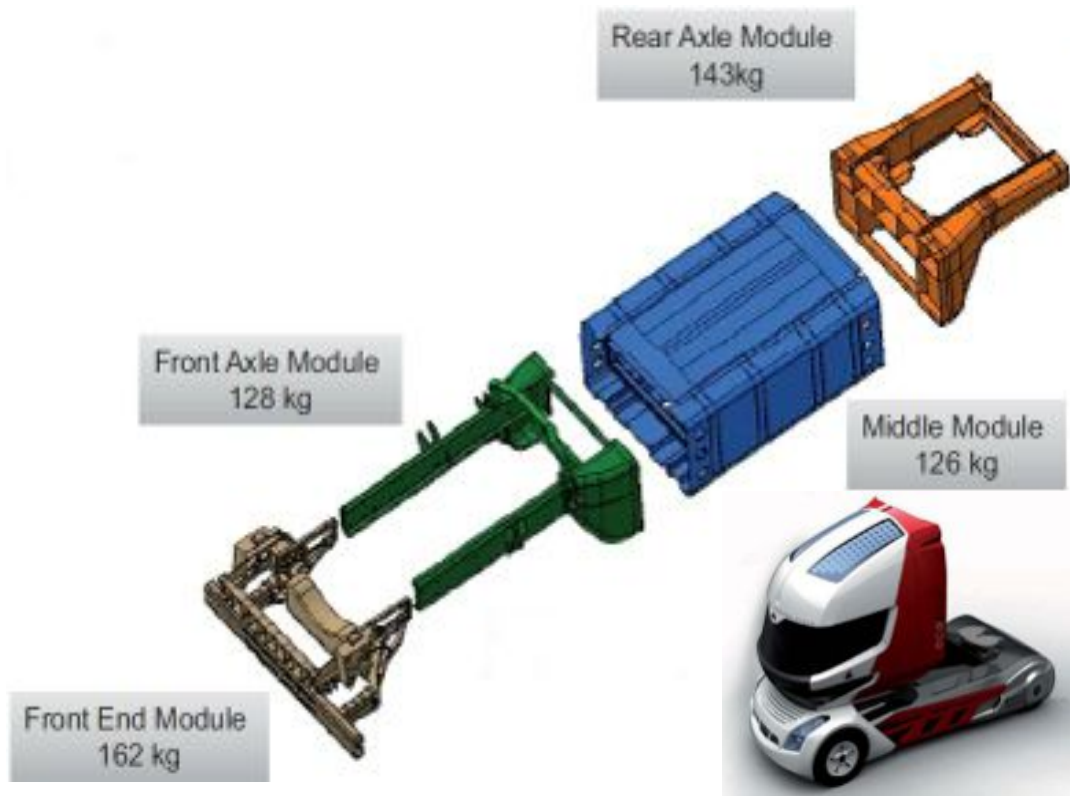


Fig. 3-22: Magna Eco Truck – lightweight heavy truck frame [WIN10, WOL10]

3.5 Key Learnings

Today all trucks have a similar design. The backbone of the tractor is the frame on which the cabin, all drivetrain parts and the suspension parts are mounted. The cabin is executed as a self-supporting unibody construction. The analysis of close to series trucks shows there will be no fundamental changes of the flat front design of tractors within the next few years. Important components that can be found on regular 40 t tractors are shown in Fig. 3-23. The optimisation of aerodynamics, passive safety and lightweight design are the most important development fields on the truck body. These components are considered in the generic reference model that is used as the basis for the optimisations in this study.

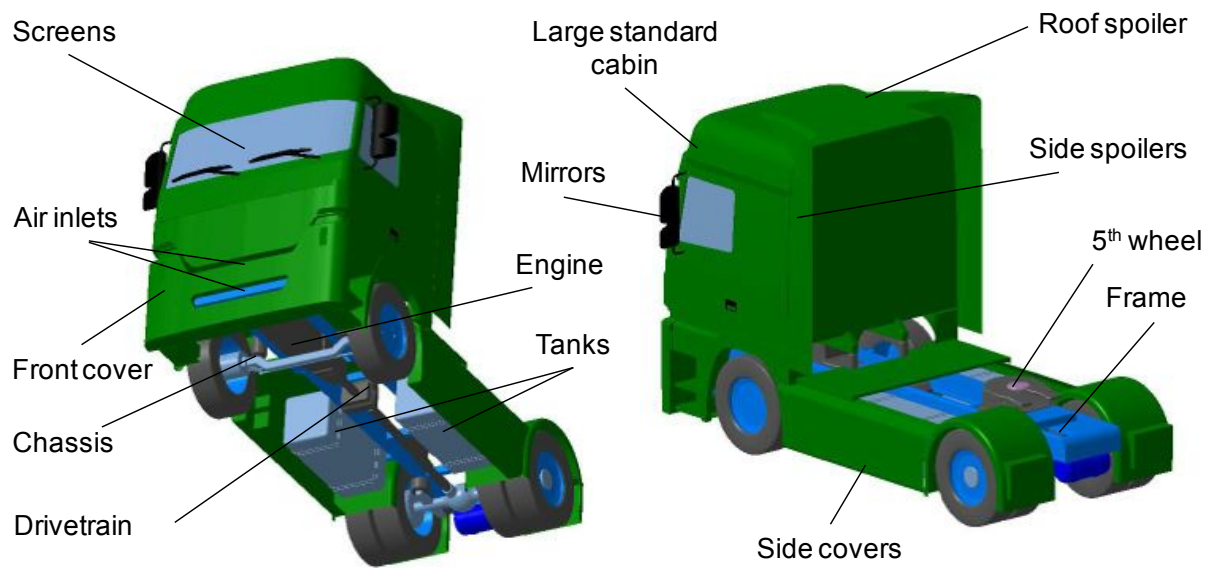


Fig. 3-23: Components of a 40 t-HGV tractor

In future the flexible integration of different drivetrain concepts will gain increased efficiency. Design studies with increased tractor length show clear advantages on aerodynamics. Additionally, improvements of active and passive safety are realised in some concept trucks. Some of the ideas shown in this chapter will be adapted for the design of the new front structure.

4 Standards and Regulations

The important Directives and Regulations released by the European Union that affect the design, the environmental and the safety performance of 40 t trucks are summarised in Fig. 4-1 to Fig. 4-4. The most important Directives and Regulations for this study are marked with an “!”.

Environment	
99/99/EC	Engine power
2003/76/EC	Emissions
2006/81/EC	Diesel emissions
2007/34/EC	Sound levels
595/2009/EC	Emissions (EURO VI)

Fig. 4-1: Important Directives and Regulations for trucks concerning environment

Passive Safety	
89/297/EEC & ECE-R 73	Lateral protection (!)
91/226/EEC	Spray suppression systems
92/114/EEC	External projection of cabs (!)
2000/40/EC & ECE-R 93	Front underrun protection (!)
2001/31/EC	Door latches and hinges
2001/92/EC	Safety glazing
2004/11/EC	Speed limiters
2005/39/EC	Seat strength
2005/40/EC	Safety belts
2005/41/EC	Safety belt anchorage
2006/20/EC	Fuel tank
661/2009/EC	General safety (!)
ECE-R 29	Pendulum tests (!)

Fig. 4-2: Important Directives and Regulations for trucks concerning passive safety

Active Safety	
70/387/EC	Doors
70/388/EC	Audible warning
94/53/EC	Identification controls
95/56/EC	Antitheft
97/39/EC	Speedometer and reverse gear
99/7/EC	Steering effort
2002/78/EC	Braking
2005/11/EC	Tyres
2005/27/EC	Indirect vision (!)
2008/89/EC & ECE-R 48	Lighting installation (!)

Fig. 4-3: Important Directives and Regulations for trucks concerning active safety

Other directives	
70/222/EC	Rear registration plate
78/507/EC	Statutory plates
94/20/EC	Mechanical couplings
96/64/EC	Towing hooks
98/91/EEC	Vehicles for transport of dangerous goods
2003/19/EC & 96/53/EC	Masses & dimensions (!)
2006/119/EC	Heating systems
2009/19/EC	Interference suppression

Fig. 4-4: Other important Directives and Regulations for trucks

Because the rear wall of the cabin in the optimised concept of this study is not changed in comparison to the reference cabin, only the front impact is of interest.

4.1 Valid Regulations

This chapter provides an overview of the important regulations affecting the design and dimensions of European Heavy Goods Vehicles. It includes those regulations that concern the frontal tractor structure and prescribe aerodynamics implications.

The optimised cabin design concept is subsequently built up in a way that ensures compliance with all of the below regulations, except for the provisions concerning maximum authorised vehicle length in national and international traffic as set out in the current version of 96/53/EC.

4.1.1 Vehicle Dimensions

A unified European Regulation was introduced in 1984. Before 1984 all European countries had their own regulations. In the context of the implementation of a common road freight, European transport market harmonised maximum vehicle lengths for all transport affecting international competition were first introduced in 1984. The total length for tractor semi-trailer combinations was set to 15.5 m (85/3/EWG).

In 1990 the maximum total length of semi-trailer trucks increased to 16.5 m (89/461/EEC). This length limit was adopted in 1996 with directive 96/53/EC. The target was to allow for sufficient productivity of vehicle combinations and to improve the driver's space. To this end, the maximum length of a semi-trailer was limited to 13.6 m and the maximum distance between the king pin and frontend of the semi-trailer to 2.04 m. The maximum authorized vehicle length in national and international traffic as set out in this directive is still valid today.

In 96/53/EC provisions are set out to Member States that allow an extension of the maximum length for vehicles that circulate on their territory. The directive stipulates that member states may only grant such allowances under strict conditions. National circulation may for instance not affect the functioning of the common EU road freight transport market.

European vehicle width for standard vehicles is limited to a maximum of 2.55 m with only Finland and the Ukraine allowing for larger vehicles for national transport that does not affect European competition. For refrigerated transports in Europe the general limit is 2.60 m.

Maximum vehicle height for free circulation across Europe is set at 4 m. One example of where a member state allows for the circulation of vehicles that deviate from this limit is the UK. In the UK national transport that does not affect international competition, is not height limited. The default high roof trailer height has become 16" (4.88 m) which allows for the circulation across the country without facing significant infrastructure boundaries on primary roads.

European HGV type approval legislation 97/27/EC, that governs the approval for new vehicle types, cross references the maximum dimensions of the circulation directive 96/53/EC. In other words: No Member States may refuse to issue European type approval to a new vehicle on the grounds of vehicle dimensions aspects, if that vehicle complies with the maximum dimensions as set out in 96/53/EC.

Member states may also issue type approval to longer, higher or larger vehicles – however their subsequent circulation is then subject to the above mentioned limitations and any Member State may refuse to accept the approval on his territory.

Important points are:

- Whereas 96/53/EC entails maximum dimensions of whole vehicle combinations, 97/27/EC governs each of the vehicles separately.
- Whenever the above conditions regarding circulation are not met, vehicles may only circulate on a national basis provided certain conditions are fulfilled.
- Vehicles exceeding the dimensions in 96/53/EC may not circulate internationally.

This study will optimise a standard tractor-trailer combination that is eligible receive type approval and to freely circulate across Europe. The most important maximum dimensions for such a combinations are shown in Fig. 4-5 [HOE06b, EEC89, ECX96]. They form the reference for the design concept.

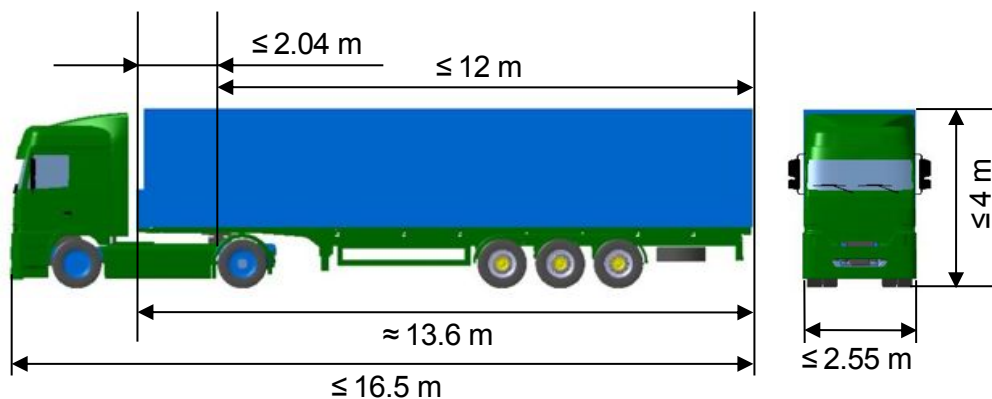


Fig. 4-5: Lengths guideline for European tractor/trailer combinations (96/53/EC)

The provisions indirectly result in a limited design space for European tractor manufacturers that offer tractors for the European general cargo market. This market, which constitutes a big share of heavy goods vehicle transport in Europe typically, features semi trailers that exploit maximal trailer dimensions. This leaves less than 2.5 m between the forward most part of the trailer and the front end of the tractor. This constraint is indirectly regulated as the difference between the maximum total vehicle length (16.50 m) and the maximum trailer length (~ 14.05 m). The resulting length defines the dimensions for tractor unit design in Europe.

The current implicit cabin length limits imposed by directive 96/53/EC result in blunt front cab-over-engine designs, which have disadvantages regarding aerodynamics and safety.

4.1.2 Vehicle Masses

The maximum laden weight of Heavy Goods Vehicles in international transport 96/53/EC is also governed by 96/53/EC. In general terms, cross border circulation of semi-trailer trucks is limited to a maximum of 40 t. For national transport and in combined transport operations with 40' ISO containers, the laden weight may deviate from this maximum weight, provided axle load requirements are met.

The load on a single axle of a tractor must be lower than 10 t, a double axle lower than 11.5 t, depending on the wheel base. The load on the drive axle of the tractor is limited to 11.5 t. The single axle load of a trailer is limited to 10 t, a double axle load to 11 t to 20 t and a triple axle load to 21 t to 24 t, depending on the axle spacing of the trailer [ECX96].

For combinations made up of a two axle tractor and a three axle trailer this results in a 40 t weight limit – being the most common configuration on European roads. 44 t vehicles must have a three-axle tractor in order to distribute the weight in accordance with the provisions. Four axle articulated vehicle combinations have a total weight limit of 36 t. If the distance between the axles of the semi trailer is more than 1.8 m a margin of 2 t can be permitted [ECX96]. Fig. 4-6 provides an overview of the possible combinations.

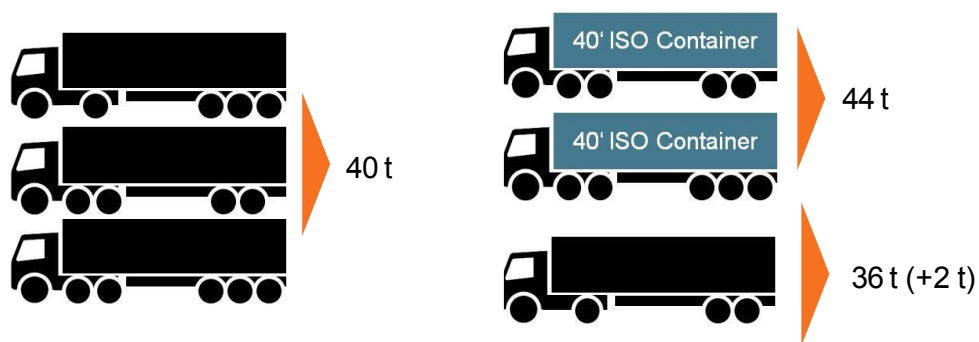


Fig. 4-6: Weight limits for semi-trailer trucks [ECX96]

Turning cycle requirements are governed by Directive 97/27/EC. Every vehicle and every vehicle combination has to be able to turn in a circle with an outer radius of 12.5 m and an inner radius of 5.3 m (Fig. 4-7). When the vehicle moves forward on either side following the circle of 12.5 m radius, no part of it may protrude the vertical plane by more than 0.8 m [ECX03].

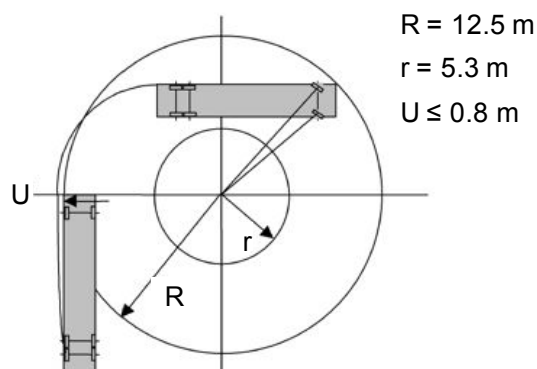


Fig. 4-7: Turning cycle requirements [ECX03]

4.1.3 Passive Safety

This chapter describes important regulated passive safety requirements. This includes requirements on external projections as well as test regulations and protection devices.

4.1.3.1 External Projections

The general requirements for external projections of Heavy Goods Vehicles are described in 92/114/EEC. It determines that no external surface of the vehicle may exhibit a part likely to catch or injure pedestrians, cyclists or motor cyclists. It mandates usage of rounded edges to decrease the likelihood of injuries (radius ≥ 2.5 mm). Frontal protective devices must have a radius of ≥ 5 mm. Parts of grilles must exhibit a radius of curvature of not less than 2.5 mm if the distance between adjacent parts is more than 40 mm. If the distance is between 25 and 40 mm, the radius must not be less than 1 mm and if the distance is less than 25 mm, the radius must not be less than 0.5 mm. The protrusion of handles, hinges, pushbuttons of doors, luggage compartments, bonnets, vents, access flaps and grab handles must be ≤ 50 mm (≤ 30 mm for pushbuttons, ≤ 70 mm for grab handles). All edges of lateral air and rain deflectors must have a radius of curvature ≥ 1 mm and sheet metal must not be touched by a sphere of 100 mm diameter or is provided with a protective covering having a radius of curvature ≥ 2.5 mm.

4.1.3.2 Pendulum Tests

The standards for pendulum tests on truck cabins are set out by ECE-R 29. These are explained in Fig. 4-8. The target is to enable enough space for the occupants without contact with rigid elements of the cabin after a collision. A minimum survival space has to be provided for every seat. In the front impact test, the impact energy for a total permissible weight ≤ 7 t is 2900 mdaN. For a total permissible weight ≥ 7 t it is 4400 mdaN. In the roof strength test, the load P is the maximum permitted weight for the front axle with a maximum weight of 10 t. The load P of the rear-wall strength tests amounts to 200 kg per ton of permitted payload [ECE93].

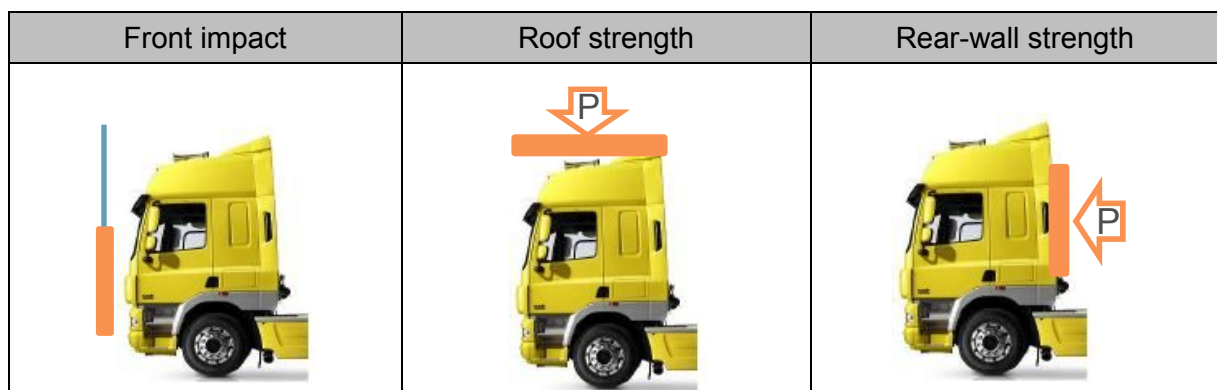


Fig. 4-8: Pendulum tests for cabins (ECE-R 29) [ECE93, DAF10]

4.1.3.3 Front Underrun Protection Device

An important body component for a frontal crash (e.g. against a passenger car) is the front underrun protection device (FUPD). ECE-R 93 describes the requirements for this component.

The section height of the FUPD cross-member should be ≥ 120 mm. The lateral extremities of the cross-member shall not bend to the front or have a sharp outer edge (rounded outside and a radius of curvature ≥ 2.5 mm). The outermost surfaces of every front guard installation shall be essentially smooth or horizontally corrugated save that domes heads of bolts or rivets may protrude beyond the surface to a distance not exceeding 10 mm [ECE94]. Other important measurements and requirements of FUPD are shown in Fig. 4-9.

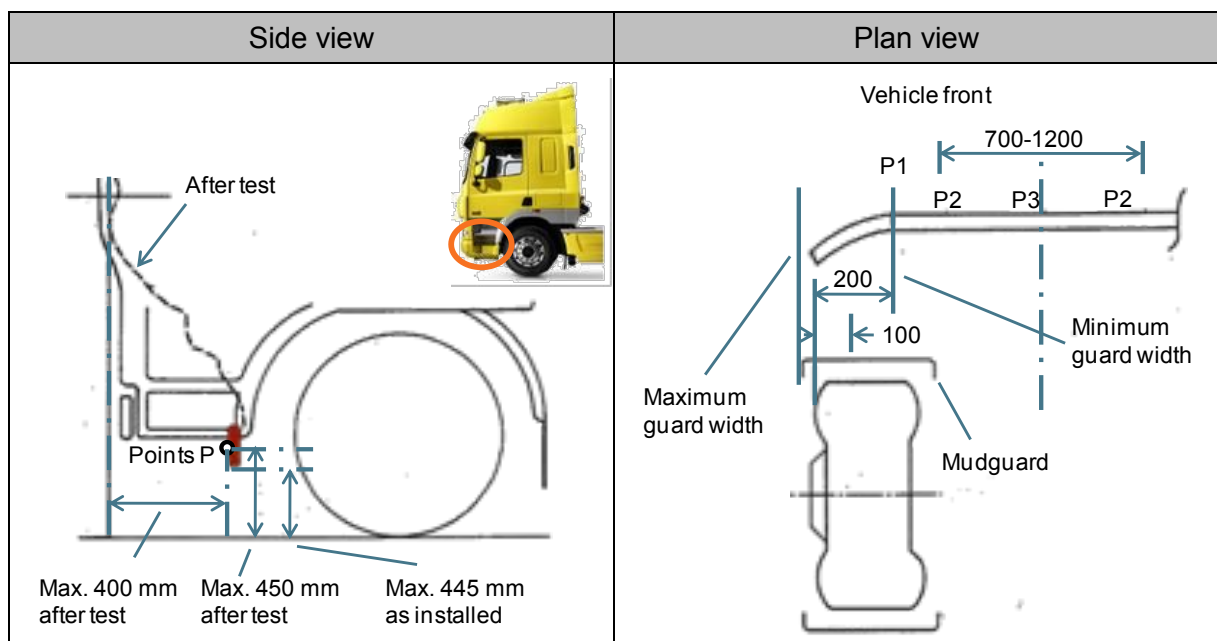


Fig. 4-9: Front underrun protection device [ECE94, DAF10]

4.1.3.4 Lateral Protection

All trucks must have an effective lateral protection in form of a special lateral protective device or special components that complies with the requirements. That means components permanently fixed to the vehicle, e.g. spare wheels, battery box, air tanks, fuel tanks, lamps, reflectors and tool boxes may be incorporated in a sideguard. Additionally they must meet the dimensional requirements of this regulation. The lateral protective device shall not increase the overall width of the vehicle. Its forward end should be turned inwards and the outer surface of the device shall be smooth, as far as possible continuous from front to rear. All external edges and corners with a radius ≥ 2.5 mm and the device may consist of a continuous flat surface or rails or a combination of both. The distance between the rails shall not exceed 25 mm and measure at least 25 mm of height. The longitudinal position shall be ≤ 300 mm rearward to the outer surface of the next tire. The edge shall consist of a

continuous vertical member extending the whole height of the guard. The lower edge of the sideguard should be ≤ 550 mm above the ground and the upper edge of the guard shall not be more than 350 mm below that part of the structure of the vehicle. Sideguards shall be essentially rigid, securely mounted and made of metal or any other suitable material. Because they are not relevant for frontal crash, the requirements are not described in detail. Further information can be found in ECE-R 73 [ECE88].

4.1.4 Towing Devices

All motor vehicles must have a special towing-device that is fitted at the front. To this towing device a connecting part, such as a towing-bar or tow-rope, may be fitted. Each special towing-device fitted to the vehicle must be able to withstand a tractive and compressive static force of at least half the authorised total weight of the vehicle, only without the towed load to which it is fitted [EEC77].

4.1.5 Active Safety

A number of active safety requirements concerning indirect vision and lighting installation are important for this study.

4.1.5.1 Direct Vision

European trucks' minimum direct field of vision is not regulated. Regulation ECE-R 125, relating to direct field of vision, only applies to passenger cars (vehicles of category M1). Notably due to the high seating position of the driver the downward vision shall be adequate to allow the driver to recognise pedestrians walking in front or besides of the cab. The downward vision is illustrated in Fig. 4-10.



Fig. 4-10: Downward vision of trucks

4.1.5.2 Indirect Vision

An important aspect of active safety on large vehicles is indirect vision as shown in Fig. 4-11.

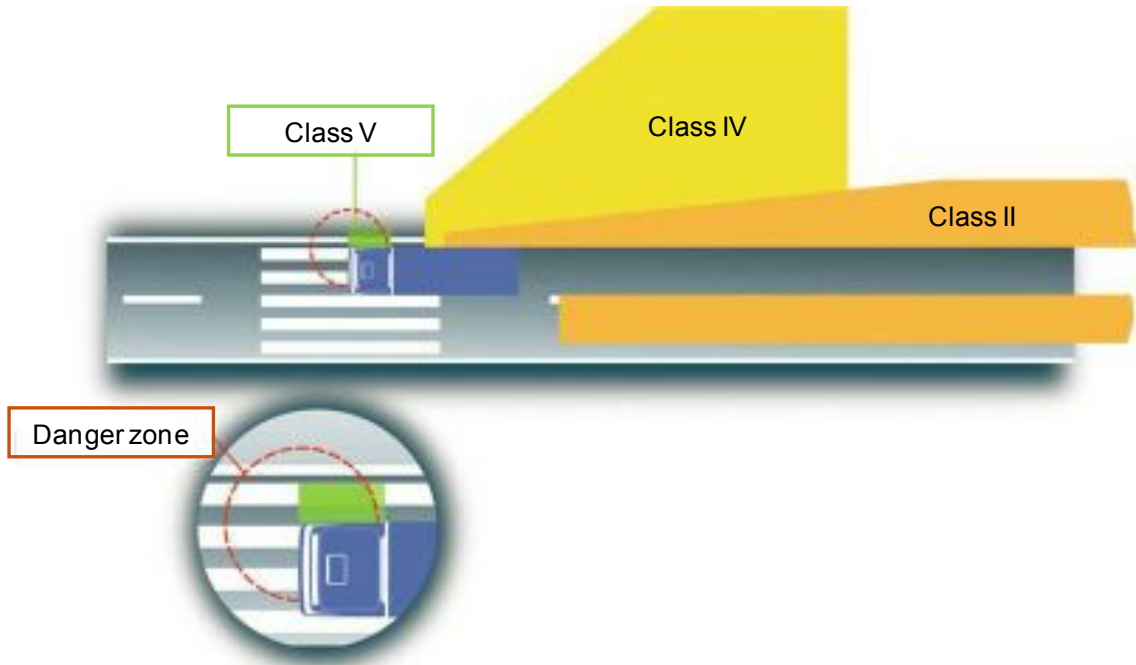


Fig. 4-11: Field of vision requirements 71/127/EEC [MEK10]

The requirements of indirect vision devices for new vehicles are set out by 2003/97/EC (Fig. 4-12). It repealed 71/156/EC and strengthened the requirements.

The vision on the passenger's side and on the driver's side is ensured by mandatory Class II and Class IV mirrors on both sides. A close-proximity mirror (class V) on the passenger side is compulsory. It must be fixed at least 2 m above the ground. A class V mirror on the driver side can be used as an option. The first-time prescribed front mirror (class VI) enables the driver to see the area directly in front of the vehicle to improve the visibility of pedestrians and cyclists. As a result the danger zone can now be seen indirectly by the driver.

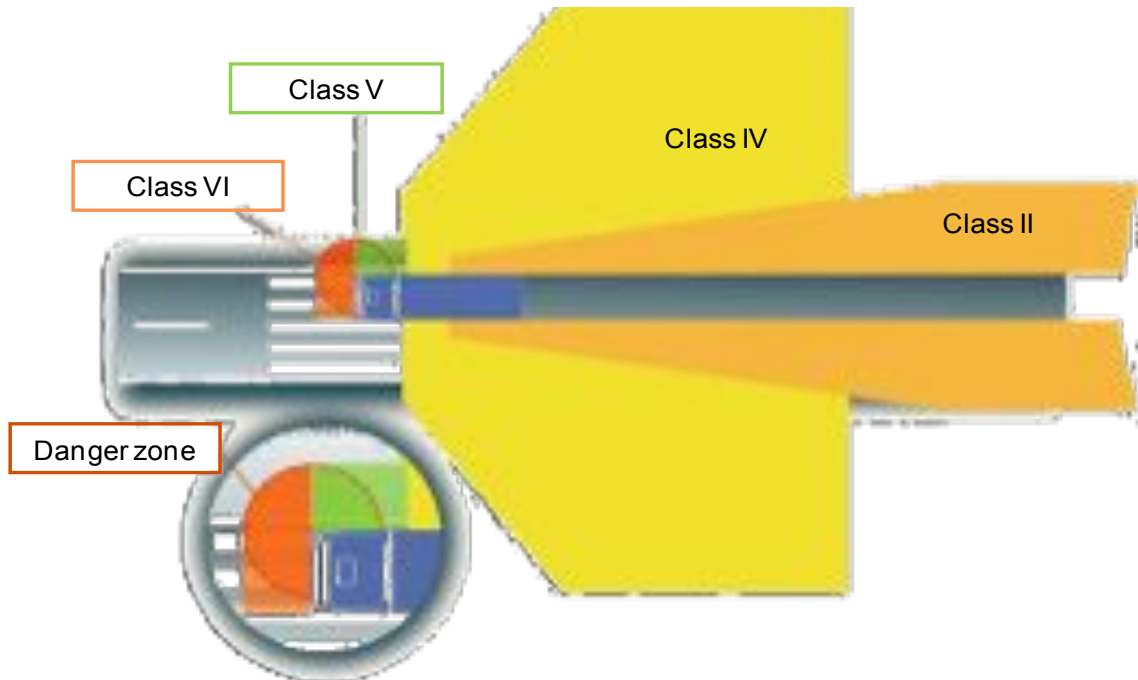


Fig. 4-12: Field of vision requirements 2003/97/EC [MEK10]

Following the adoption of 2003/97/EC the European Commission has mandated stricter requirements of existing vehicles through the adoption of 2007/38/EC which governs retrofitting requirements of indirect vision devices. This has improved the safety level across the fleet.

The differences in the field of vision between 71/127/EEC and 2003/97/EC for class IV and class V mirrors are shown in Fig. 4-13.

Comparison of field of vision requirements for class IV mirrors		
<p>71/127/EEC = 215 m²</p>	<p>2003/97/EC = 308 m²</p>	<p>Difference = 93 m²</p>
Comparison of field of vision requirements for class V mirrors		
<p>71/127/EEC = 2.25 m²</p>	<p>2003/97/EC = 5.5 m²</p>	<p>Difference = 3.25 m²</p>

Fig. 4-13: Field of vision requirements 2007/38/EC [DOD09]

With the fulfilment of directive 2003/97/EC about one third of the potential blind spots can be eliminated. An additional elimination of blind spots is possible with the usage of supplementary devices like the ones shown in Fig. 4-14. Using a Fresnel lens, an elimination of 78 to 90 % of the blind spots is possible. The optimum position on the passenger side is the bottom of the window. A retrofitting of trucks with this lens is possible, but also an implementation to a laminated screen of new trucks is feasible [DOD09].



Fig. 4-14: Supplementary devices to reduce blind spots [DOD09]

An alternative solution is using curvature mirrors like a Dobli mirror or a BDS mirror. The BDS mirror eliminates 37 to 75 % of the blind spots and the Dobli mirror 43 to 76 %. Both fulfil the directive 2003/97/EC for class IV and class V mirrors but are difficult to adjust without special ground markings. But they do not fulfil the requirements for the indirect field of vision for all ocular points.

4.1.5.3 Lighting Installation

Another important regulation for active safety is ECE-R 48 that governs the lighting installations of all road vehicles. The positions of the different lamps are shown in Fig. 4-15. The most important lamps for driving at night are the headlamps (Fig. 4-15, position 1). Two or four main-beam headlamps are mandatory for trucks > 12 t. The headlamps must not cause any discomfort to the driver either directly or indirectly through mirrors or reflecting surfaces of the vehicle. If four headlamps are used, only one per side is allowed to be used for bending light. The headlamps have to ensure a conical illumination ($\leq 5^\circ$) of the forefield [ECE08].

Also beneath the main-beam headlamps, two dipped-beam headlamps (Fig. 4-15, position 2) are mandatory. Their position is described in ECE-R 48. The edge of the apparent surface in the direction of the reference axis, which is farthest from the vehicle's middle plane, shall not be more than 400 mm from the extreme outer edge of the vehicle. The inner edges of the apparent surfaces in the direction of the reference axes shall not be less than 600 mm apart. The height should be between 500 mm and 1200 mm above the ground level. In addition no discomfort to the driver either directly or indirectly through mirrors or reflecting surfaces of the vehicle is allowed to occur. The allowed lighting angle are 15° upwards and 10° downwards as well as 45° outwards and 10° inwards [ECE08].

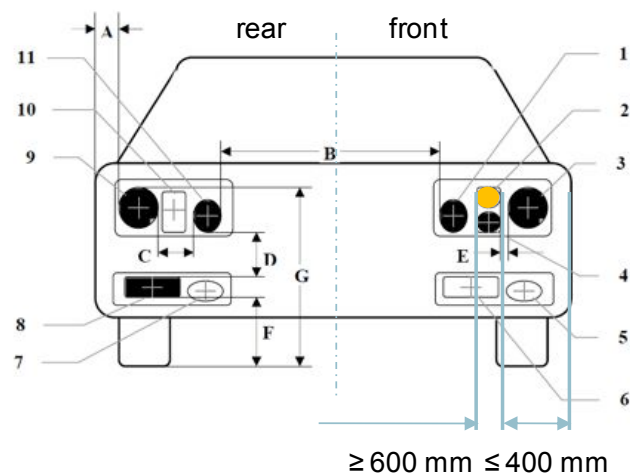


Fig. 4-15: Position of lighting installation [ECE08]

Front fog lamps (Fig. 4-15, position 3) are optional on motor vehicles. The edge of the apparent surface in the direction of the reference axis, which is farthest from the vehicle's middle plane, shall be not more than 400 mm from the extreme outer edge of the vehicle. Their position in height is established between 500 mm and the maximum height of the vehicle. Analogous to the other front lamps, no discomfort to the driver either directly or indirectly through mirrors or reflecting surfaces of the vehicle is allowed to occur. The allowed lighting angle are 5° upwards and downwards as well as 45° outwards and 10° inwards [ECE08].

Direction indicator lamps (Fig. 4-15, position 5 and 7) are mandatory for all vehicles. Different categories of lamps are used. Category 1, 1a and 1b are front direction indicator lamps, category 2a and 2b are rear direction indicator lamps, category 5 and 6 are side direction indicator lamps. A description of their illumination angles is shown in Fig. 4-16. The edge of the apparent surface in the direction of the reference axis which is farthest from the vehicle's middle plane shall be not more than 400 mm from the extreme outer edge of the vehicle. The inner edges of the apparent surfaces in the direction of the reference axes shall be not less than 600 mm apart. The height above ground level is between 500 mm and 1500 mm for category 5 and 6 lamps. Category 1, 1a, 1b, 2a and 2b have to be arranged between 350 mm and 1500 mm in height. Optional direction indicator lamps have to be fixed more than 600 mm above the mandatory lamps. The side direction indicator lamps must be fixed less than 1800 mm behind the front direction indicator lamps [ECE08].

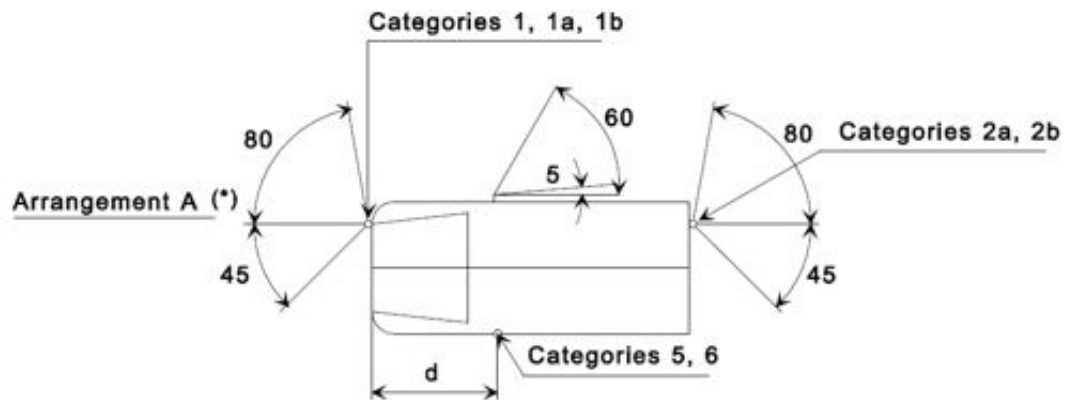


Fig. 4-16: Illumination angles of indicator lamps [ECE08]

In the rear part of a vehicle, two rear position lamps (Fig. 4-15, position 9) are mandatory for all vehicles. The edge of the apparent surface in the direction of the reference axis which is farthest from the vehicle's middle plane shall not be more than 400 mm from the extreme outer edge of the vehicle. The inner edges of the apparent surfaces in the direction of the reference axes shall not be less than 600 mm apart. The height should be between 350 mm and 1500 mm above ground. The allowed lighting angle are 45° inwards and 80° outwards as well as 15° above and below the horizontal plane [ECE08].

In addition to these lamps, all vehicles exceeding 2.1 m in width must have end-outline parking lamps. Two of them must be fixed in the front and two in the rear of the vehicle. These lamps must be attached ≤ 400 mm from the outer edge of the vehicle. They must have a lighting angle of 80° outwards, 5° above and 20° below the horizontal plane [ECE08].

Also two front and two side reflector lamps are mandatory for all vehicles exceeding 2.1 m in width. These lamps are also attached in an area less than 400 mm from the outer edge of the vehicle. Their position in height is between 250 and 900 mm above ground level and they shall have a lighting angle of 30° inwards and outwards as well as 10° above and below the horizontal plane [ECE08].

4.2 Future Regulations

The General Safety Regulation 661/2009/EC announces the repeal of directives that were identified as vital in the context of this study, namely on indirect vision and type approval. Indirect vision requirements will be globally harmonised. The commission has already aligned legislation with existing UNECE regulations on these issues. 97/27/EC will be converted into a directly applicable European regulation. This will likely happen in comitology. Work has started concerning weights and dimensions. Whereas an extension of aerodynamic devices from measurement might be added to the future type approval regulation, this would not allow for longer integrated cabin designs since devices are detachable.

To identify more future regulations, the latest global technical regulations (GTRs), proposals for GTRs and candidates for GTRs are analysed for relevance. For GTRs and candidates for GTRs no relevant regulations for heavy trucks have been identified.

On the one hand this is a proposal to develop a regulation concerning the common definitions of vehicle categories, masses and dimensions (TRANS/WP.29/AC.3/11). The target is to harmonise the commonly given definitions of the category, mass and dimensions of vehicles in all GTRs to help the contracting parties in establishing and adopting GTRs.

On the other side this is a proposal to develop a global technical regulation concerning vehicles with regard to the installation of lighting and light-signalling devices (TRANS/WP.29/AC.3/4). This proposal has several targets. One target is to harmonise the regulation on installation of lighting and light-signalling. This should have positive effects on the safety of the travelling public worldwide. Light signalling devices should convey a simple, understandable message. In addition this should lead to a cost reduction of vehicle design and production costs for manufacturers. It would be possible for a manufacturer to design, stamp or mould one set of body panels for a vehicle model if a harmonised GTR would exist. The consumer would benefit by having better choice of vehicle lighting built to better, globally recognized regulations providing a better level of safety and at lower price [TRA05, TRA03].

In addition working documents of different working parties of the last years have been analysed. These are GRSP (Working Party on Passive Safety), GRSG (Working Party on General Safety Provisions), GRE (Working Party on Lighting and Light-Signalling) and GRPE (Working Party on Pollution and Energy). In the GRSG one relevant document has been identified that is a proposal for amendments to devices for indirect vision (ECE/TRANS/WP.29/GRSG/2010/9). The target is to reduce side-swipe incidents when large vehicles are changing lanes on motorways by providing a better visibility for the driver. This should result in an enlargement of the visible area in the side of the truck as described in Fig. 4-17. The visibility can be realised by direct vision or via indirect vision by using devices.

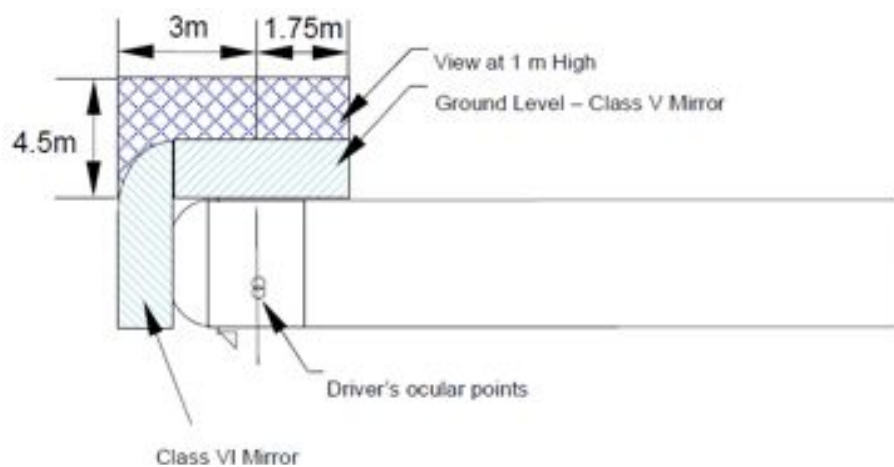


Fig. 4-17: Improvement of direct and indirect visibility for lane changing [GRS10]

An outlook on future active safety systems that could become mandatory for new trucks is described in the directive 661/2009/EC. In this direction national authorities are advised to refuse new vehicles without an electronic stability control system starting in 2011. More than that this directives advised the commission to assess advanced emergency braking systems, lane departure warning system and tyre pressure monitoring systems to become a mandatory installation in future [ECX09].

4.3 Key Learnings

Requirements that result from Directives and Regulations are summarised in Fig. 4-18. This figure includes the Directives and Regulations that are important for this study.

The most constraining regulation in this study is the length limitation by 96/53/EC. This regulation obstructs improvements of passive safety and aerodynamics. In the past an adaptation of the length has been realised to improve road safety, for environmental reasons or to improve rentability. The same reasons are discussed in this study to increase maximum total length with the important condition of unchanged loading lengths. Changes of the front structure will also result in changes of the axle load. Clearly existing axle load provisions have to be fulfilled.

The most important requirements on passive safety are described in 92/114/EEC. In addition the requirements on front underrun protection devices are described in ECE-R 93. Apart from these regulations, also the requirements on active safety concerning indirect vision (2003/97/EC) and lighting installation (ECE-R 48) have to be fulfilled by the new concept. Pendulum tests as described in ECE-R 29 will be substituted by crash tests in this study (see chapter 6.3).

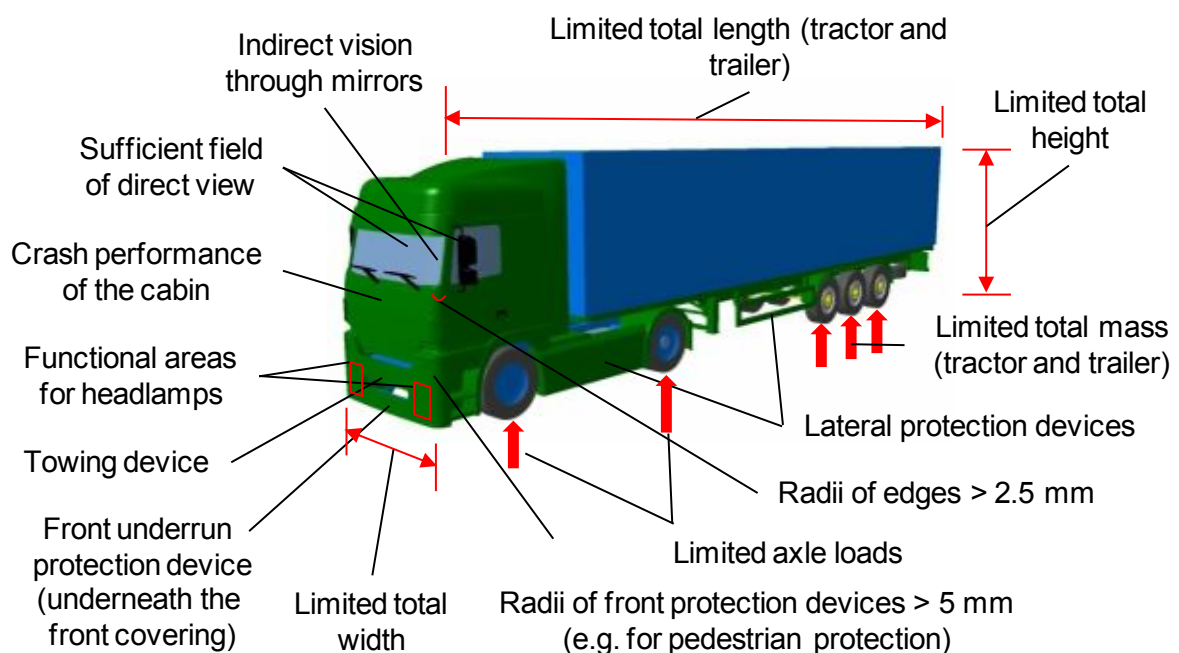


Fig. 4-18: Important requirements from Directives and Regulations

The influences by requirements on lateral protection improve aerodynamics (ECE-R 73). These are regarded as marginal for this study as well as influences on the front structure by towing devices (77/389/EEC).

Finally a detailed recommendation for changes in length limitation with regard to active and passive safety requirements is elaborated in this study. Chapter 9 will contain a detailed explanation of how the new concept complies with all of the above identified regulatory boundaries.

5 Build-up of CAD Models

In this chapter the build-up of the CAD models that are required as input data for the investigation is described. Therefore first a reference truck is defined. After this, three optimised base concepts are derived, which can be used as the basis for a second optimisation step.

5.1 Definition of Reference Truck

To evaluate the influence of optimisations on a 40 t-HGV truck, CAD data of a reference model is built up. This reference model shall represent a state of the art long haul truck. As a basis scan points of the outer skin of a 40 t-HGV tractor are used. Therefore a typical representative tractor with a good aerodynamic performance according to the state of the art design is chosen. A CAD model is derived from these scan points and their resulting curves. The cabin is a common large standard cabin. To improve its aerodynamics, a roof spoiler and two side spoilers are implemented in the CAD model. Missing components, like the crash structure for example, are taken from a real tractor. Therefore a tractor, in use by fka, is investigated and important dimensions are taken from it to complete the CAD model.

Especially, the limitations of dimensions and masses result in a similar appearance of the tractors from different manufacturers. Fig. 5-1 shows that only design elements like the geometry of lamps and the grille give a tractor the identity of a special brand. For that reasons these design elements are limited to functional areas in the generic reference model, so the tractor serves as a generic model.



Fig. 5-1: Design elements of different manufacturers [WOL10]

In this study a conventional trailer with board walls is used for the reference truck as well as for the optimised concept. The data for the semi-trailer are measured from a real semi-trailer. Some of the trailer dimensions are shown in Fig. 5-2. To build up CAD data that are capable

as a basis for an FE model, special attention is paid to the respective material thicknesses and the joining technologies.

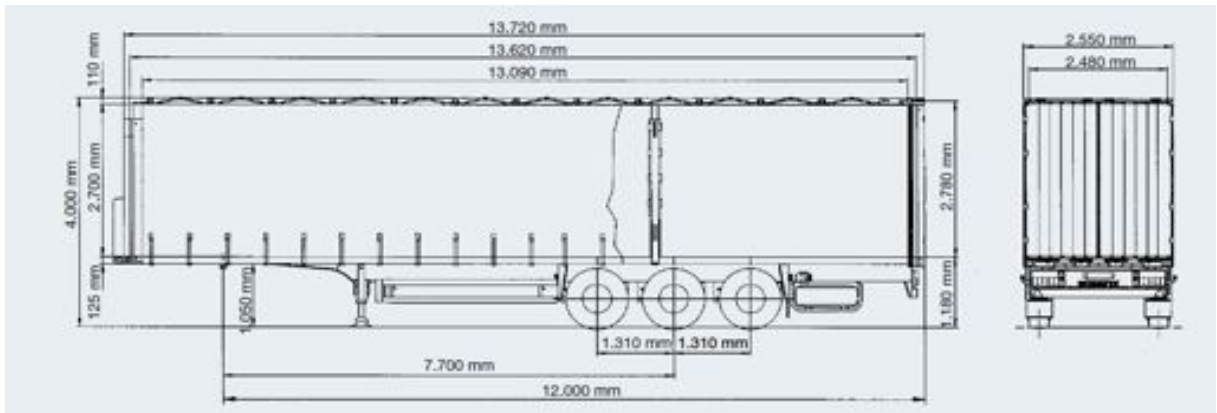


Fig. 5-2: Dimensions of a standard semi-trailer [SCB10]

The resulting CAD model of the reference truck is shown in Fig. 5-3. This truck is used as a basis for the evaluation of the new concept. It contains all important aerodynamic devices of a modern truck.

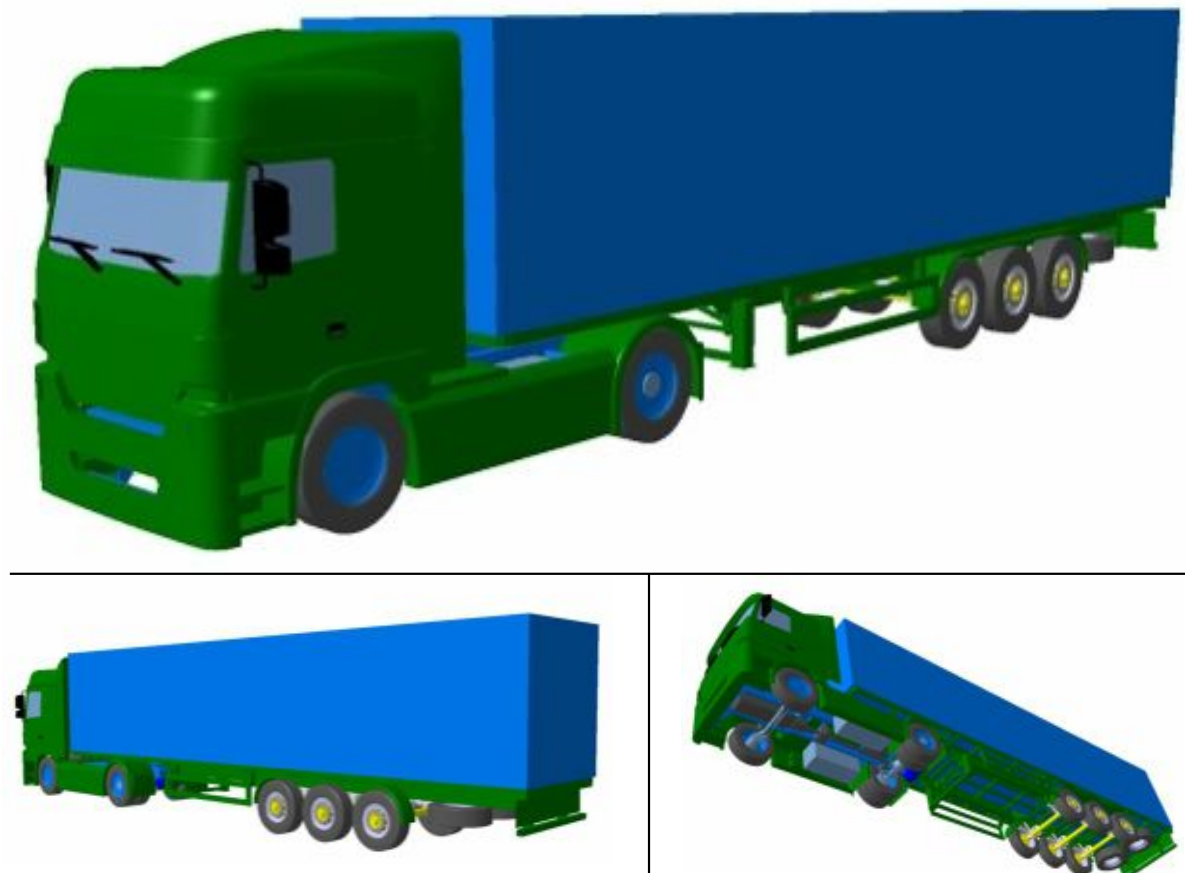


Fig. 5-3: Reference truck

5.2 Optimised Base Concepts

As a first step three optimised base concepts are set up. After investigation of the base concept properties one of these concepts is selected by means of a pre-assessment to undergo further optimisation measures.

The models of the optimised base concepts are based on the reference CAD data. For that reason the geometry of the integrated concept from the APROSYS project will be transferred to the 40 t-HGV tractor of this study. Within this step, three different additional lengths (400 mm, 800 mm, and 1200 mm) will be provided to the front structure of this reference tractor. This also includes a repositioning of the front axle. The usage of CAD data simplifies the consideration of structural changes in the FE models. The FE models for CFD, crash and VRU protection simulations directly base on this CAD data.

The three base concepts are shown in Fig. 5-4. The length extension of 400 mm at the optimised base concept 1 effects that there are slight disadvantages regarding the approach angle, because the position of the front axle is not changed in this concept. But since this concept is not designed for off road use, this disadvantage is accepted. The position of the front axle and the stairs are reorganised in base concept 2 and base concept 3 to ensure a sufficient approach angle and an easy entry for the driver. The length extension of base concept 2 is 800 mm. The wheelbase is extended by 400 mm. Concept 3 has an extended length by 1200 and a lengthened wheelbase by 800 mm. In the construction of these optimised base concepts, important requirements from directives (see Fig. 4-18) are considered. Beneath the requirements for passive safety (e.g. large radii for VRU protection) also active safety requirements are considered. One important component is the windscreen. To ensure the direct field of vision is comparable to the reference truck, a large curved windscreen is needed. The side windows must be redesigned to minimise occultation by the A-pillar. Because the trailer remains unchanged, it is not displayed in these pictures.

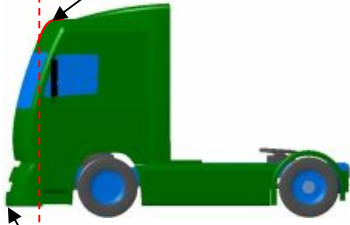
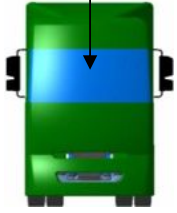
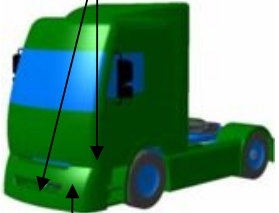
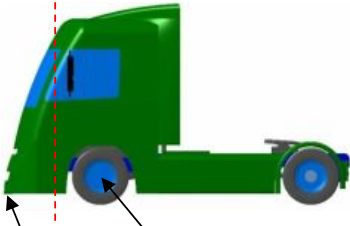
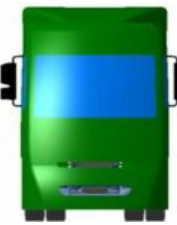

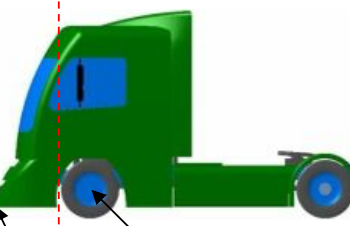


	Side view	Front view	Isometric view
Base concept 1	<p>Reference plane</p> <p>Larger edge radius for improved aerodynamics</p>  <p>400 mm length extension</p>	<p>Larger windscreen</p> 	<p>Smaller radius of front and larger radii at the edges for improved aerodynamics</p>  <p>Deflective shape of front</p>
Base concept 2	<p>Reference plane</p>  <p>400 mm extension of wheelbase</p> <p>800 mm length extension</p>		
Base concept 3	<p>Reference plane</p>  <p>800 mm extension of wheelbase</p> <p>1200 mm length extension</p>		

Fig. 5-4: Optimised base concepts

6 Safety and Aerodynamic Concepts

In this chapter a detailed description of the completed FE simulations is realised. This includes a description of the important technical knowledge and the results of FE simulations.

6.1 CFD Simulations

The most important aerodynamic fundamentals concerning 40 t-HGVs are described in this chapter. Afterwards the optimisation of the new front structure is described.

6.1.1 Aerodynamic Fundamentals

Typical values for the aerodynamic drag coefficient of different vehicles are shown Fig. 6-1. Whereas passenger cars have an aerodynamic drag coefficient (c_D) between 0.25 and 0.42, most trucks have a drag coefficient > 0.6 . The reason for that are the large front area and the dimensions of the truck that are optimised to carry as much payload as possible by legislation. In addition, the drag coefficient of an articulated truck is larger than that of a semi-trailer truck, because of the larger gap between tractor and articulated trailer [HOE08].

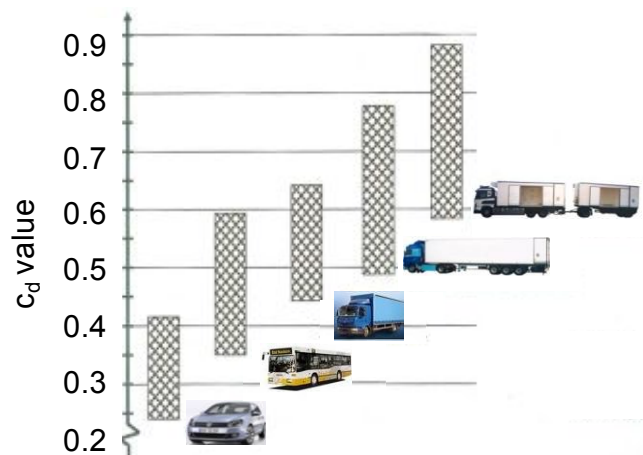


Fig. 6-1: c_D value of different vehicle types [HOE08]

The aerodynamic drag increases in the area with high dynamic pressure in the front (Fig. 6-2). The fitting stream in the roof area of the cabin results in a reduction of aerodynamic drag. The c_D value continuously increases in the rugged substructure of the truck. A radical increase of aerodynamic drag results in the gap between cabin and trailer that is caused by a low pressure area in this gap. This behaviour can be optimised by the usage of spoilers on the roof and side flaps at cabin or a combined device of these two. In the area of the trailer a fitting stream reduces the drag again. At the end of the trailer a radical increase of the drag caused by a low pressure area exists.

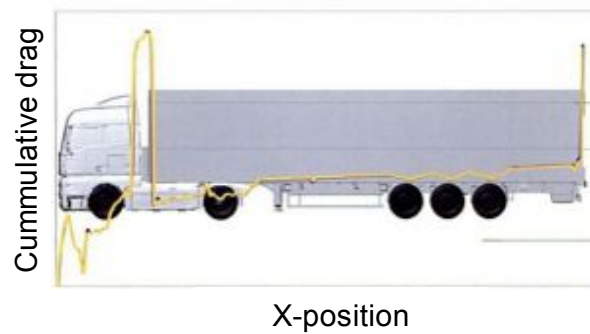


Fig. 6-2: Behaviour of aerodynamic drag at a truck [HOE08]

Important for the reduction of aerodynamic drag of a semi-trailer truck is the usage of a roof spoiler on top of the cabin if the height of the trailer is larger than the height of the cabin. The correct setting of the adjustable roof spoiler avoids having a second dynamic pressure area at the trailer's front wall (Fig. 6-3). However, it is important to adjust the spoiler in an optimum position. If it is too steep, the aerodynamic drag also increases because of its own dynamic pressure area. In addition a steep spoiler increases the negative pressure between the driver's cab and the trailer. This results in a lateral flow and an enlargement of the separated flow region in the following section of the trailer. A non optimised setting of the spoiler can result in 3 % higher fuel consumption [HOE08].

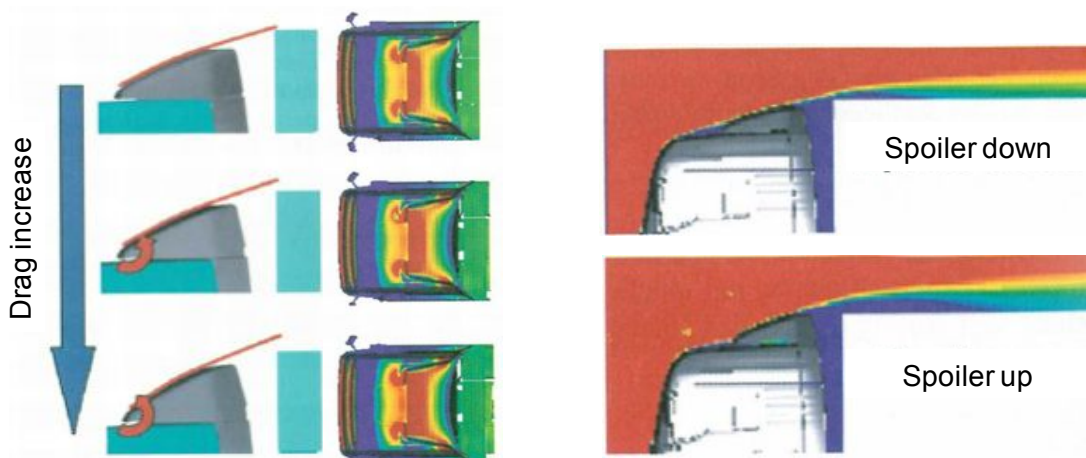


Fig. 6-3: Relevance of spoiler setting

The influence of an angular stream is shown in Fig. 6-4. The quotient of the tangential force coefficient (c_T), that results from the stream lateral to the driving direction and the aerodynamic drag coefficient (c_D) directly depends on the stream angle. Especially streaming angles between 3° and 15° have a large influence on the behaviour of trucks [HOE08].

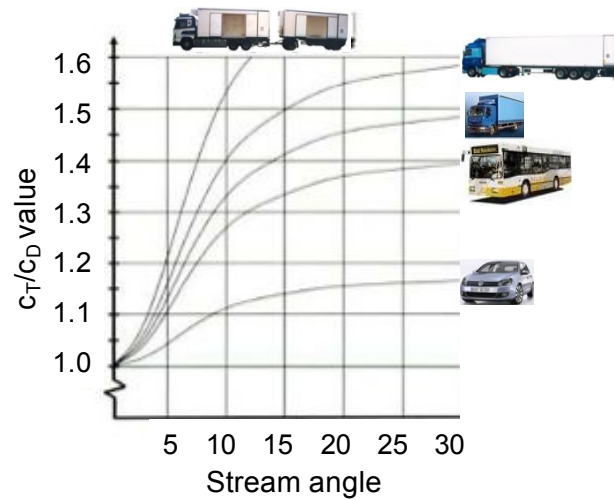


Fig. 6-4: Influence of stream angle [HOE08]

A reduction of the influence of angled stream is possible by the usage of an aerodynamic package (Fig. 6-5). Especially of angle $> 10^\circ$ a high pressure area in front of the trailer's front wall increases the aerodynamic drag. With the usage of side spoilers, this area remains at low pressure with a better aerodynamic drag [HOE08].

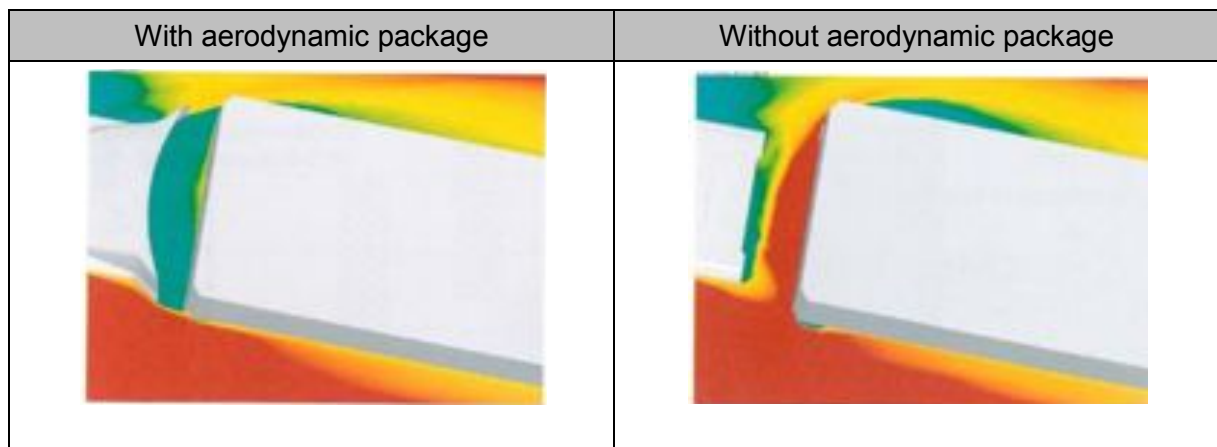


Fig. 6-5: Influence of the aerodynamic package at 10° stream angle [HOE08]

This shows that the usage of deflectors is very important. The difference in fuel consumption of a truck using deflectors and a truck not using deflectors is shown in Fig. 6-6. A truck with deflectors has lower fuel consumption. For that reason deflectors are already implemented in the reference truck (see Fig. 5-3).

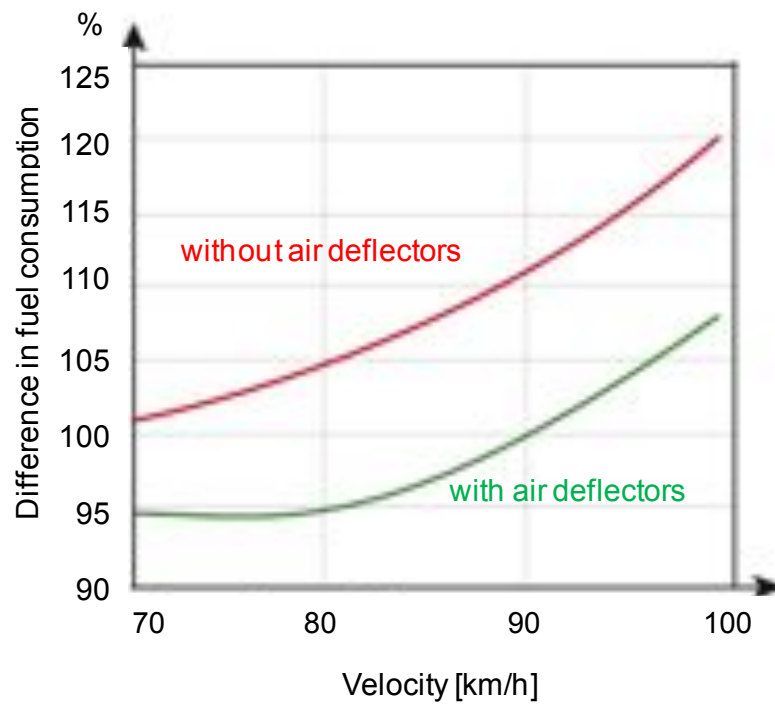


Fig. 6-6: Importance of deflectors [STÜ07]

Different measures to decrease the c_D value by the usage of deflectors are shown in Fig. 6-7. By the usage of deflectors a decrease of the c_D value $> 21\%$ is possible, with the usage of an optimised deflectors a decrease of up to 34% is possible.

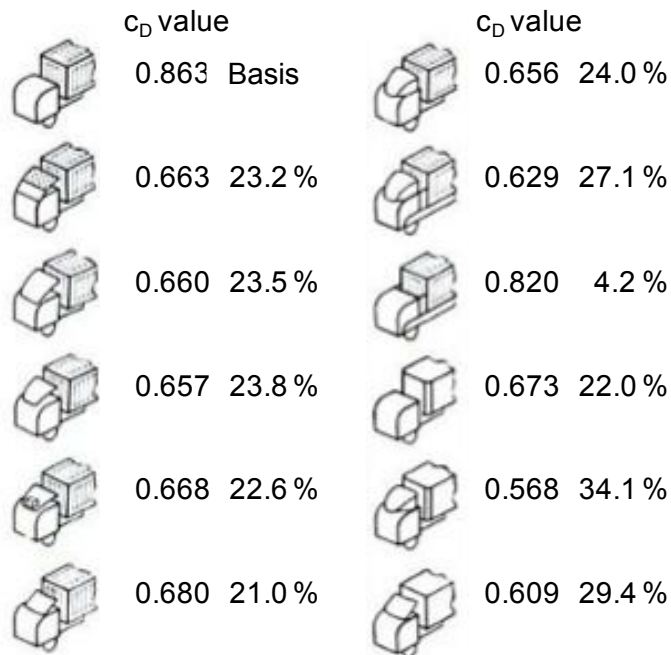


Fig. 6-7: Decrease of c_D value by air deflectors [HUC08]

6.1.2 CFD Simulations of the Reference Truck

The aim of the CFD simulations is to identify the aerodynamic performance of the different concepts. Since the c_D value is independent from the truck's speed the flow velocity is arbitrary for the simulations. But to reproduce realistic conditions a velocity of the truck of 85 km/h (23.61 m/s) is accepted. This means the air flow towards the truck and the street underneath the truck have a velocity of 85 km/h. The truck itself is a static wall. To consider the influence of rotating wheels, these are admitted with a rotation speed equivalent to the velocity of 23.61 m/s. The CFD model of the reference truck is shown in Fig. 6-8.

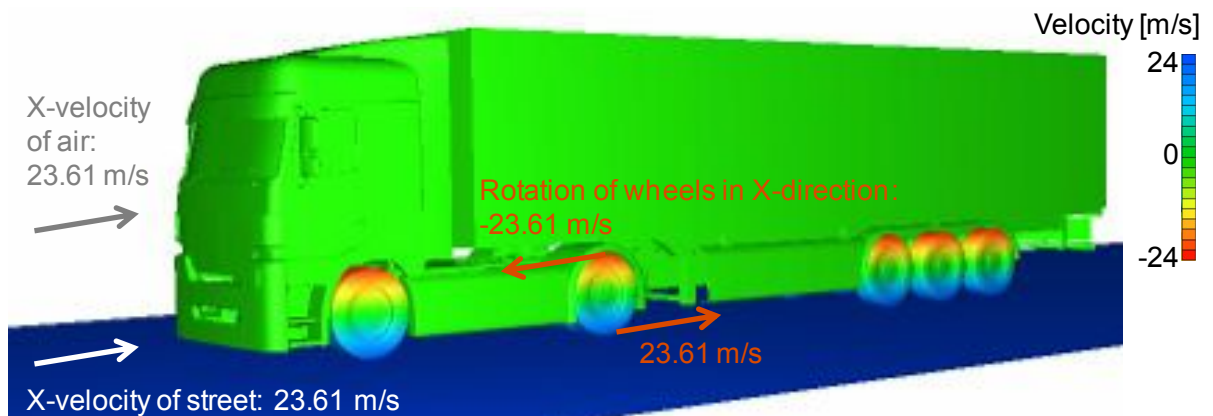


Fig. 6-8: Velocity of important components of the CFD model (reference truck)

The target is to identify the aerodynamic performance of the new truck in comparison to the reference truck. Therefore changes in the c_D value, the flow and velocity of flow are analysed as well as differences in pressure and the velocity. The relationship between velocity and pressure is described by the equation of Bernoulli. It reveals that the energy resulting from pressure and the energy resulting from velocity must be constant in sum. This is shown in Fig. 6-9. In front of the truck the high pressure results in low velocity of the air. In the upper part of the tractor there is an area of low pressure that results in a high velocity of air. Behind the truck high turbulences occur as a third kind of energy. For that reason pressure and velocity are low in that area.

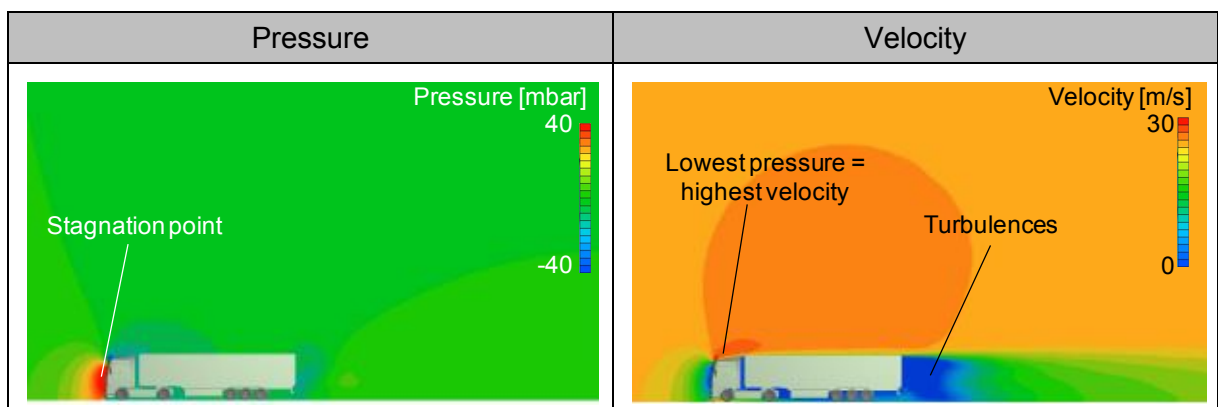


Fig. 6-9: Pressure and velocity in the surrounding of the truck

The most important parameters for the determination of the aerodynamic drag are the pressure and the friction resistance. The pressure resistance results from the pressure distribution in the boundary layers of the truck. Fig. 6-10 shows the pressure in the boundary layer of the truck. The highest pressure occurs in the stagnation point in the front area of the tractor. In addition to that also at the mirrors high pressures can occur. This pressure diversification results in a longitudinal force that is mandatory for the aerodynamic drag. The friction resistance results from the velocity gradient between the truck (that is a stationary wall) and the air flow around the truck with a high velocity. Because of the tangential cohesion of the fluid (air), friction effects between the fluid and the surface of the truck result in a second longitudinal force.

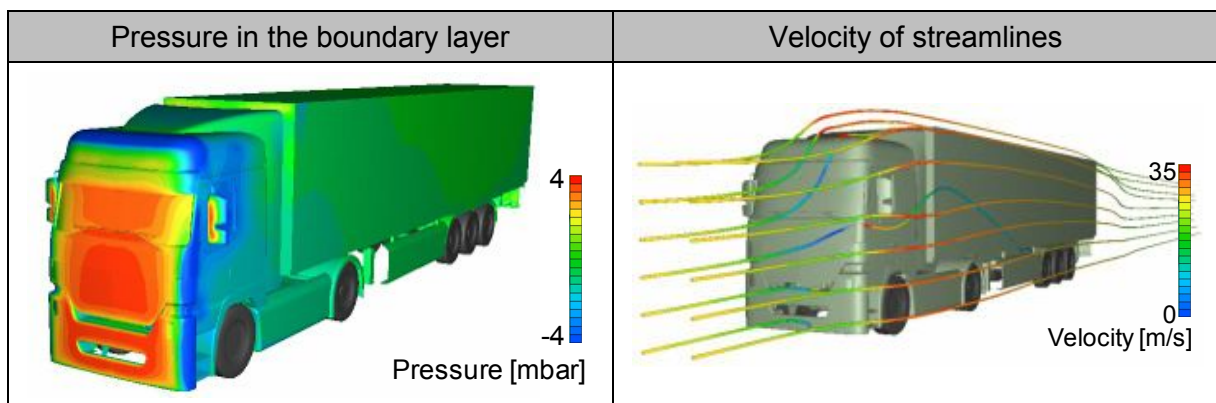


Fig. 6-10: Pressure in the boundary layer and velocity of streamlines

Because rotating wheels are considered in the CFD model, the air adheres on the surface of the wheels and starts to rotate in the wheel house (Fig. 6-11). This is an important effect on the total aerodynamics of a vehicle. Additionally the drivetrain and the air inlets in the front of the tractor are considered to model the flow through the tractor. These details are also considered for the optimised concepts.

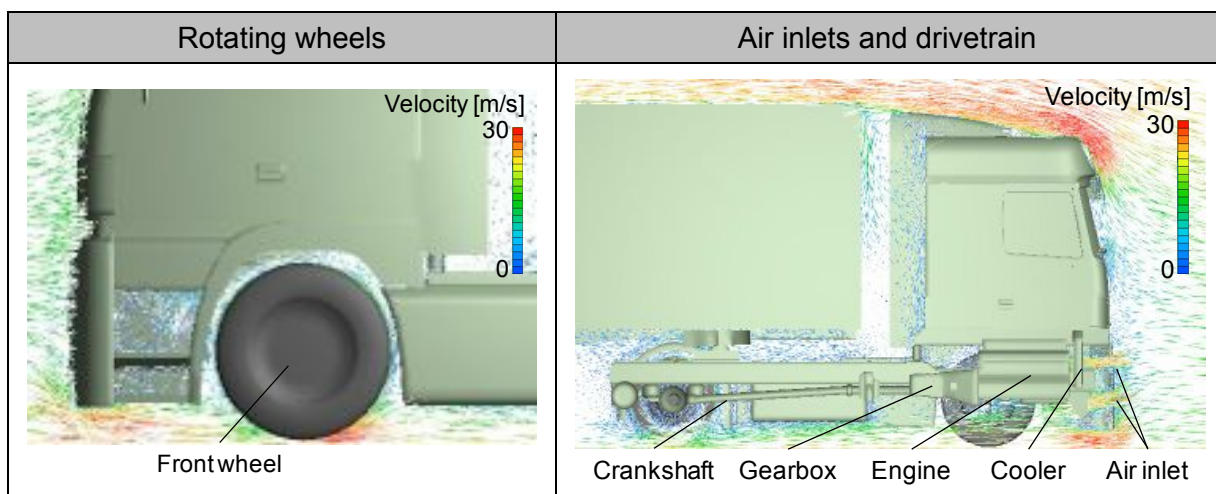


Fig. 6-11: Flow in the wheel house and the engine compartment

A detailed analysis of the aerodynamics of the reference truck shows high turbulences with high air speeds behind the main-mirror. In addition a high pressure occurs on the front surface on these components. Another area with high pressure is the sun visor and the area on the windscreen (underneath the sun visor). Also the windscreen wipers cause turbulences and an area of high pressure.

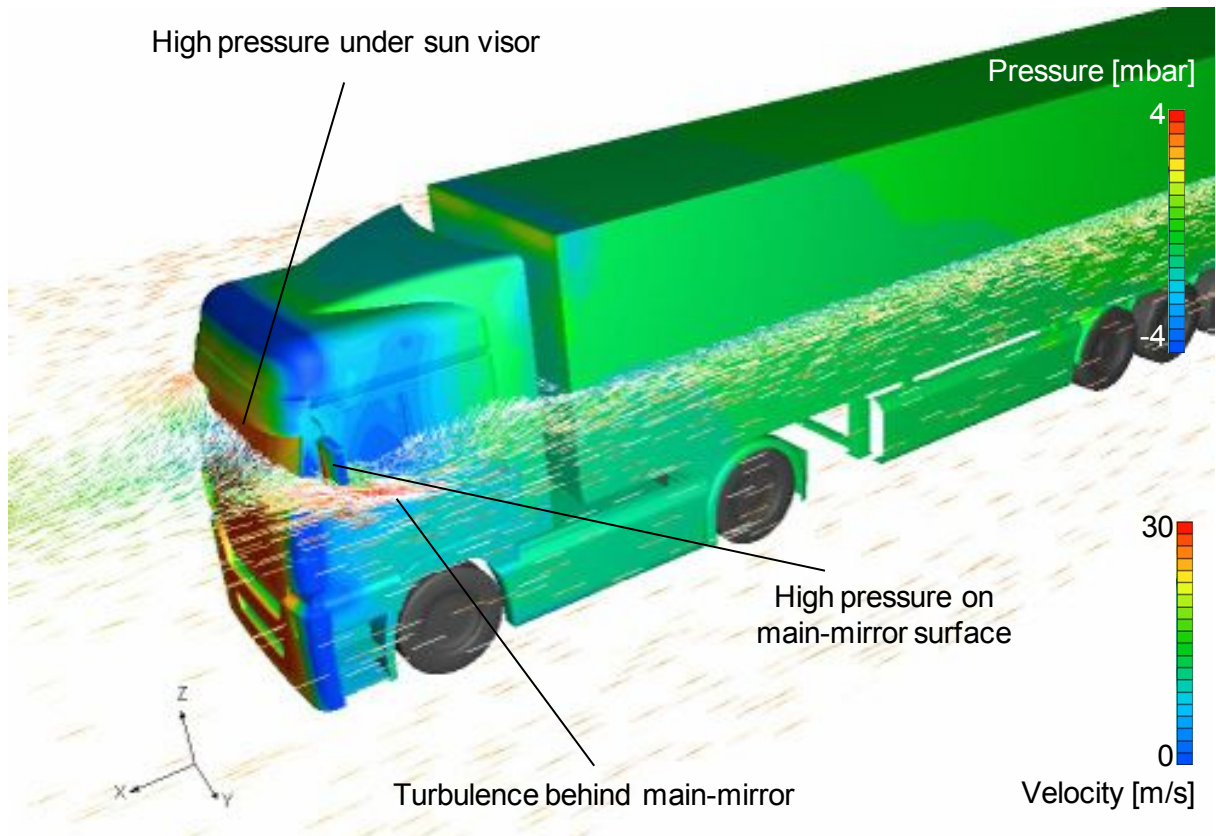


Fig. 6-12: Optimisation potential at the main-mirrors and the sun visor

The main mirrors are required by law, so they must be considered also for the optimised concept. But to evaluate the influence of the sun visor, this component is removed from the reference truck. In an optimised concept the installation of windscreen wipers could be improved by hiding them underneath outer skin parts. To erase the influence of the wiper they are also removed from the reference truck.

The result of this new CFD simulation is compared with the conventional reference truck with wipers and sun visor in Fig. 6-13. The reference truck with wipers and sun visor has a c_D value of 0.729. By omission of the sun visor and the wipers the c_D value can be decreased to 0.703. This is a decrease of 3.57 % in comparison to the reference truck with wipers and sun visor. The areas of high pressure that are reduced by omitting the sun visor and the main-mirrors are marked in Fig. 6-13. The basis for the comparison of the optimised concepts and the reference tractor will be the best reference case, so the reference truck without sun visor and wipers.

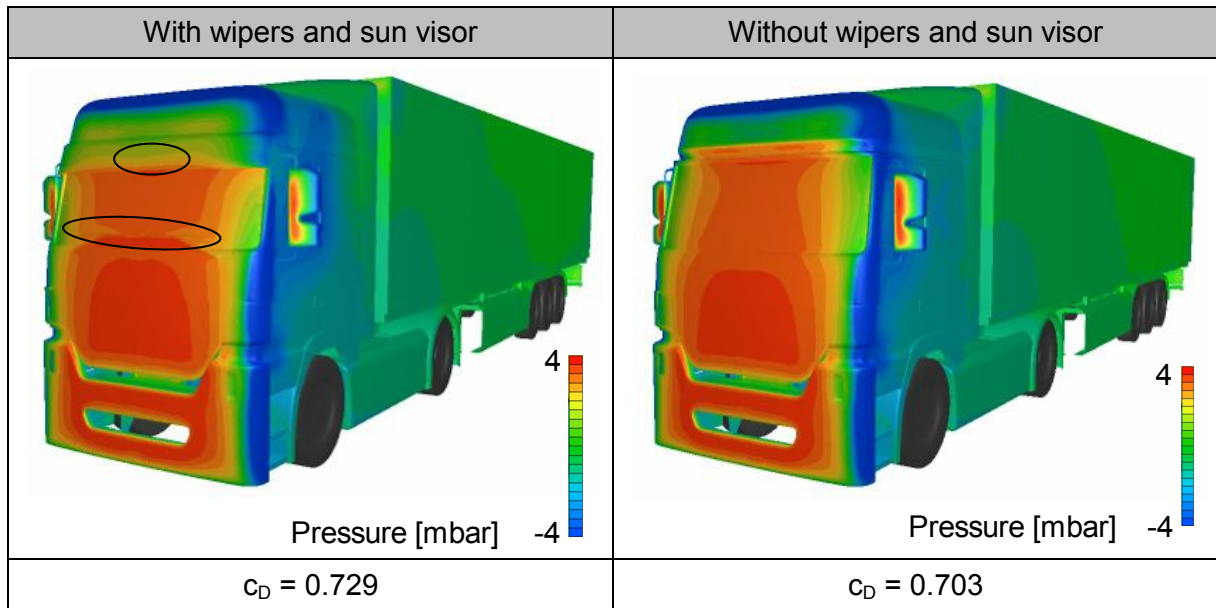


Fig. 6-13: Influence of main-mirrors and sun visor

6.1.3 CFD Simulations of the Optimised Base Concepts

CFD Simulations are executed for all three optimised base concepts. Fig. 6-14 shows the comparison of the pressure distribution of the reference truck and base concept 1.

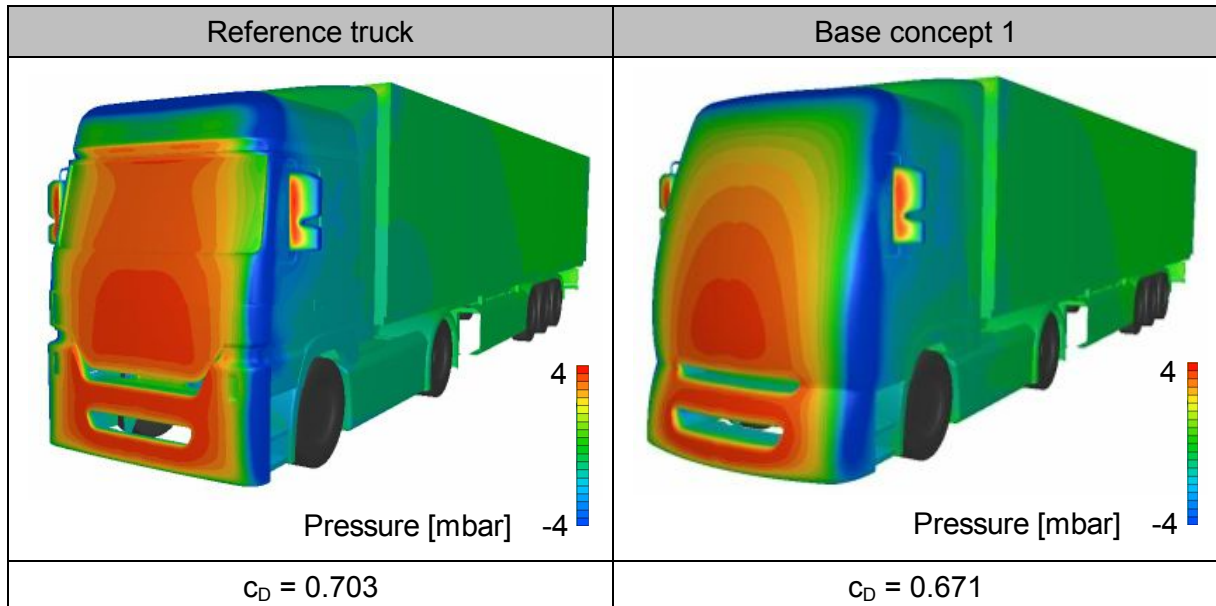


Fig. 6-14: Pressure distribution of reference truck and base concept 1

By extending the vehicle front by 400 mm the high pressure areas in the middle are reduced. This leads to a reduced c_D value of 0.671, which means a reduction of 4.61 % compared to the reference truck. The pressure distributions of base concept 2 and base concept 3 are shown in Fig. 6-15.

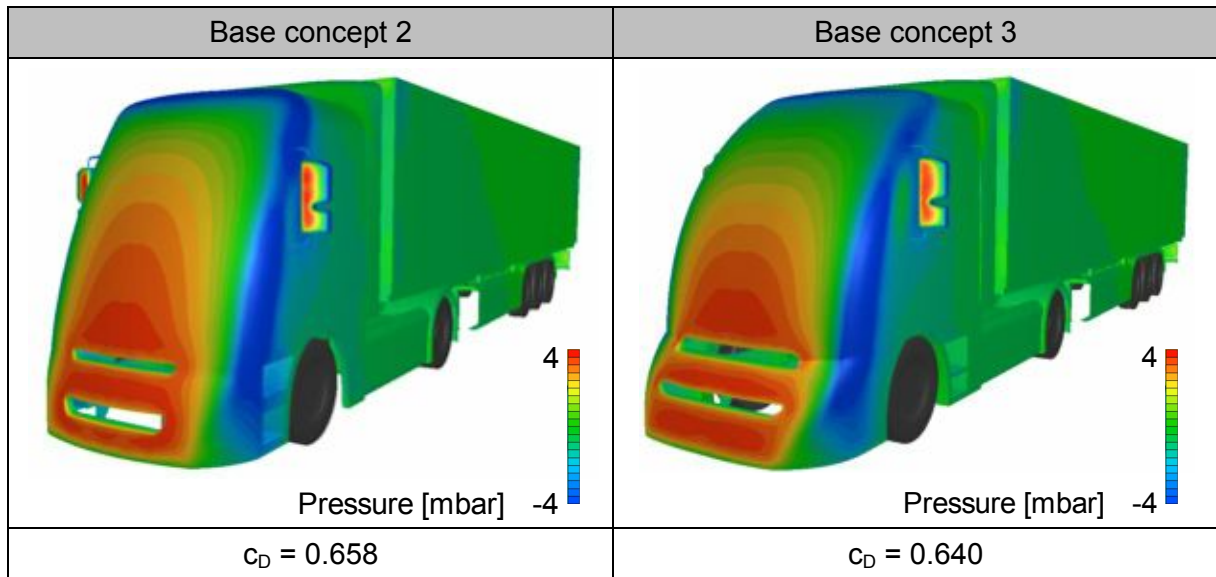


Fig. 6-15: Pressure distribution of base concept 2 and base concept 3

Base concept 2 and base concept 3 show further reduced areas of high pressure. Furthermore the change-over from high pressure to low pressure areas are smoothed. The c_d value of base concept 2 is reduced by 6.39 % compared to the reference truck. Base concept 3 achieves a reduction of 8.89 %. The velocities in the streamlines of all concepts can be seen in Fig. 13-1 in the attachment of this study.

6.1.4 Selection of Concept for Additional Optimisation

For execution of further optimisation measures one concept is selected. Therefore the general concept features are pre-assessed in regard to compliance with the permissible axle loads and its operability is investigated. Fig. 6-16 shows measurements and forces working on the tractor.

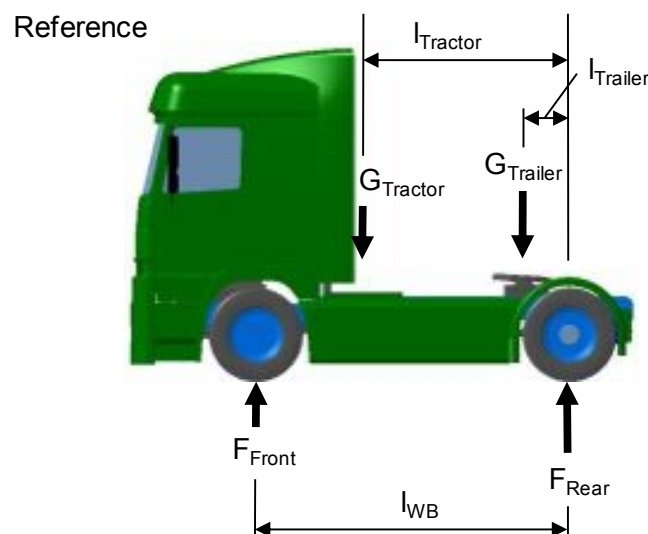


Fig. 6-16: Forces working on tractor

The loads for a tractor carrying a fully loaded trailer are assumed as follows:

$$G_{\text{Total}} = G_{\text{Trailer}} + G_{\text{Tractor}} = 18 \text{ t} \cdot g \quad \text{Eq. 6-1}$$

$$G_{\text{Tractor}} = 8 \text{ t} \cdot g \quad \text{Eq. 6-2}$$

$$G_{\text{Trailer}} = 10 \text{ t} \cdot g \quad \text{Eq. 6-3}$$

$$F_{\text{Front}} = 6.5 \text{ t} \cdot g \quad \text{Eq. 6-4}$$

$$F_{\text{Rear}} = 11.5 \text{ t} \cdot g \quad \text{Eq. 6-5}$$

The rear axle load F_{Rear} of 11.5 t must not be exceeded because of legal requirements. The centre of gravity of the tractor is calculated in Eq. 5-6 and Eq. 5-7.

$$G_{\text{Trailer}} \cdot l_{\text{Trailer}} + G_{\text{Tractor}} \cdot l_{\text{Tractor}} = F_{\text{Front}} \cdot l_{\text{Wb}} \quad \text{Eq. 6-6}$$

$$l_{\text{Tractor}} = \frac{F_{\text{Front}} \cdot l_{\text{Wb}} - G_{\text{Trailer}} \cdot l_{\text{Trailer}}}{G_{\text{Tractor}}} \quad \text{Eq. 6-7}$$

The reference truck has a wheelbase of 3730 mm. So the centre of gravity is 2318 mm in front of the rear axle. Since base concept 1 has the same wheelbase as the reference truck the centre of gravity can also remain unchanged to assure the compliance of maximum rear axle load. To achieve this for base concept 2 with a wheelbase of 4130 mm the centre of gravity must be at least 2643 mm in front of the rear axle. This means that the gravitational centre has to be moved 325 mm towards the front. Because the concept provides more design space in the front this can be achieved by accordant package measures. For base concept 3 a shifting of the centre of gravity by 750 mm is required. Therefore more comprehensive measures are necessary.

The extension of the wheelbase does not only complicate to assure the compliance of the permissible rear axle load, it also has disadvantages regarding operability. Manoeuvring is more difficult with vehicles with long wheelbases. The general concept features are pre-assessed in Fig. 6-17.




	Base concept 1 	Base concept 2 	Base concept 3 
Aerodynamic performance	-	+	+
Compliance with axle loads	+	o	-
Operability	+	o	-
-: moderate o: neutral +: good			

Fig. 6-17: Pre-assessment of optimised concepts

The pre-assessment shows that base concept 2 is the best compromise. It has sufficient improvement of the aerodynamic and safety concept and still ensures good operability. Hence it is selected to undergo further aerodynamic optimisation.

6.1.5 Advanced Concept

The further optimisation measures aim for an additional reduction of high pressure areas in the middle of the front structure and the low pressure areas at the front edges that cause high flow velocities and high friction forces. Therefore a smaller curvature radius is applied to the middle part of the front. In contrast, the edges are carried out with larger radii. Furthermore the concept is equipped with optimised main mirrors that are adapted to the front shape. Fig. 6-18 shows the further advanced concept.

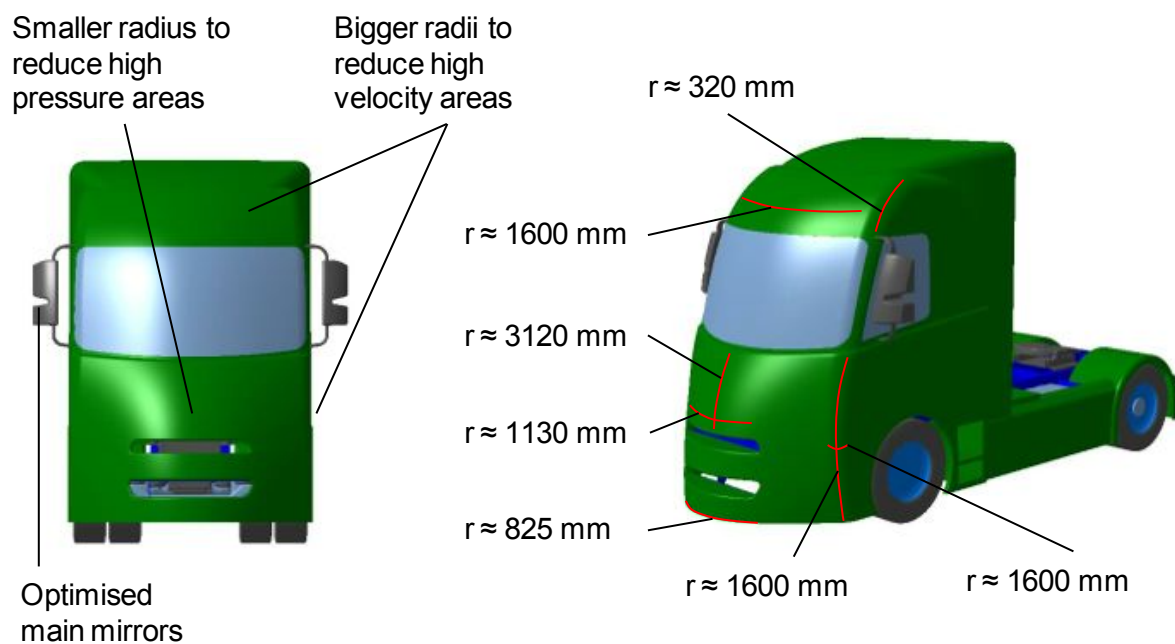


Fig. 6-18: Advanced concept

To prove that the requirements regarding manoeuvrability are fulfilled, a multi-body simulation of the advanced concept is executed. Fig. 6-19 and Fig. 6-20 show the simulation result. It can be seen that the requirements according to 97/27/EC are fulfilled.

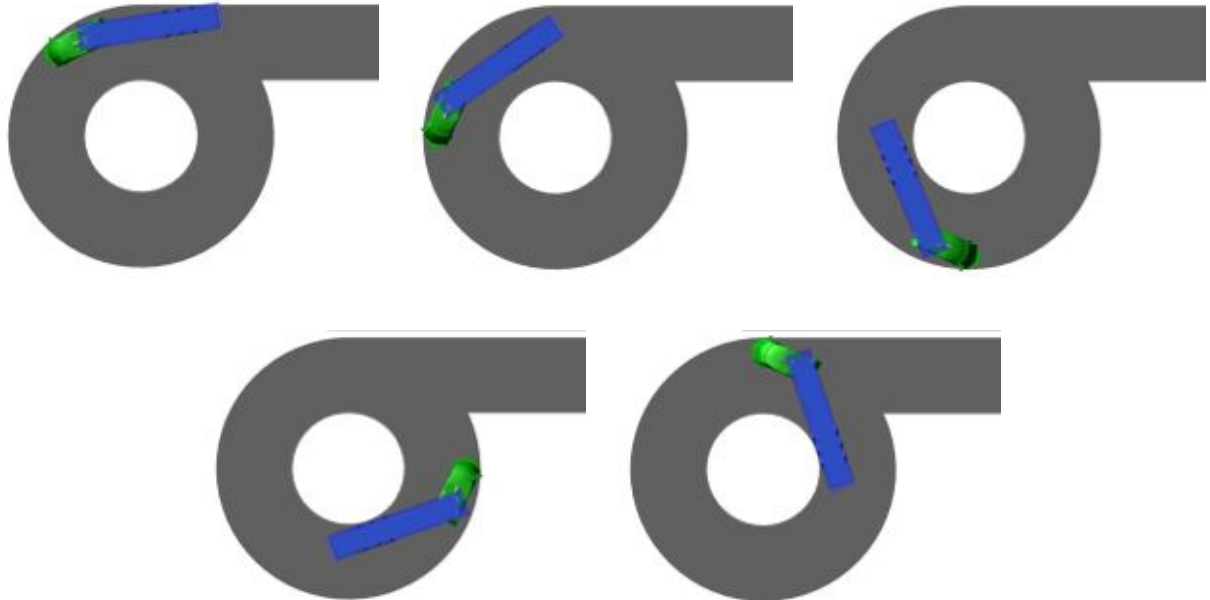


Fig. 6-19: Manoeuvrability of advanced concept in top view



Fig. 6-20: Manoeuvrability of advanced concept (3D)

The advanced concept also fulfils the requirements regarding the external projections of the cabin governed by 92/144/EEC. The advanced concept does not have any exterior parts that face outwards so they could be dangerous for pedestrians. Furthermore the radii at the grill are larger than 2.5 mm. The bumper covers are bended inwards as governed by the regulation. Also the edges of the steps are rounded. Further paragraphs of 92/144/EEC are related to parts that are not considered in this early concept stage like for example the door handles, brand labels and wheel nuts. The general design changes of the advanced concept do not have any effect on this level of detail. Hence it can be assumed that all requirements can be met. Fig. 6-21 shows the arranged measures to achieve compliance with 92/144/EEC.

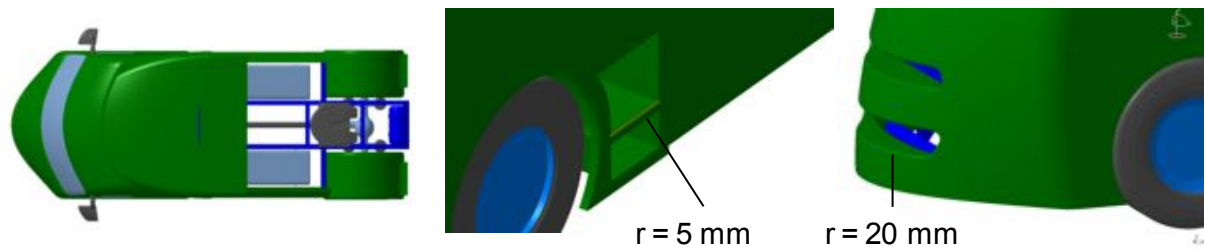


Fig. 6-21: Measures for compliance with 92/144/EEC

The lateral protection device remains unchanged compared to the reference truck. The relocation of the entrance steps does not affect the protection device. Hence the concept can fulfil the lateral protection device requirements set by 89/297/EEC and ECE-R 73 in the same way as state of the art trucks with entrance steps behind the front axle (e.g. Renault Magnum).

The configuration for the front impact pendulum test described in ECE-R 23 is shown in Fig. 6-22. The advanced concept provides additional crush zone for energy absorption. Hence it is to expect that the advanced concept shows better test results than the reference tractor. There are no disadvantages to expect regarding the roof strength and rear wall strength test, because there are no changes in general structural cabin design.

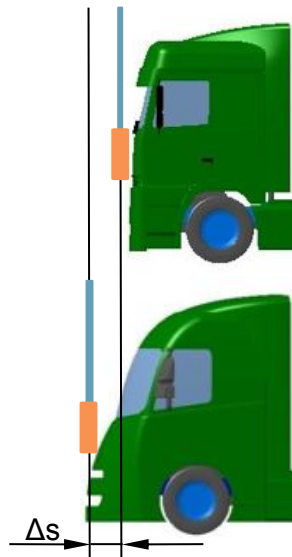


Fig. 6-22: Pendulum test

CFD Simulations of the advanced concept reveal that the c_D value is reduced by 6.11 % compared to base concept 2. Compared to the reference truck a reduction of 12.10 % is achieved. Fig. 6-23 and Fig. 6-24 show the pressure distribution of base concept 2, the

advanced concept and the reference truck. The Figures also disclose that the high pressure area on the optimised main mirrors is reduced compared to the reference mirrors.

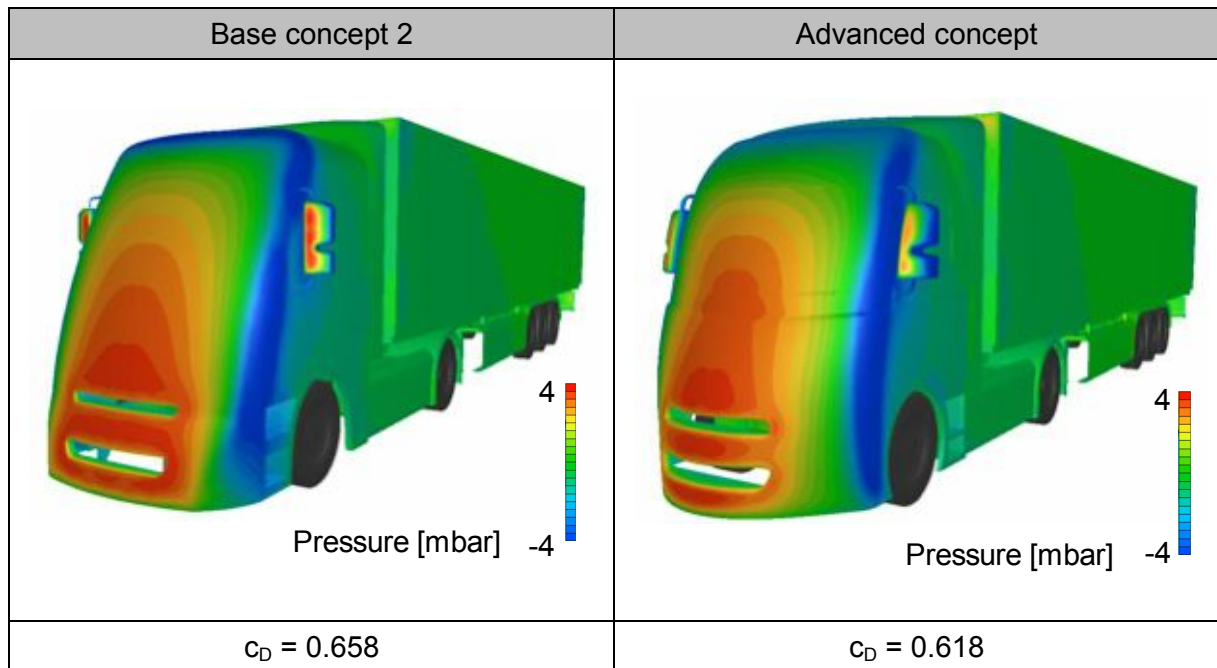


Fig. 6-23: Advanced concept compared to base concept 2

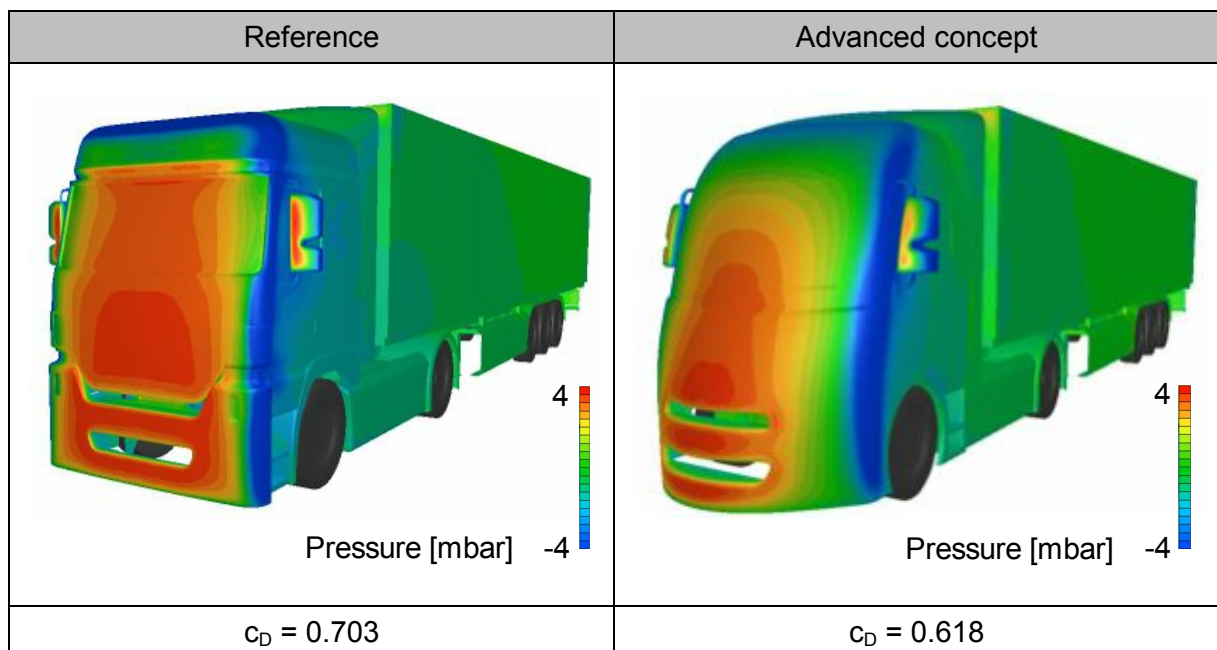


Fig. 6-24: Further optimised concept compared to reference

6.2 Wind Tunnel Tests

To validate the CFD simulation results wind tunnel test are executed at the Chair of Flight Dynamics at the RWTH Aachen University. The setup of the test facilities can be seen in Fig. 6-25. The operating speed range of this wind tunnel reaches from 0 to 70 m/s.

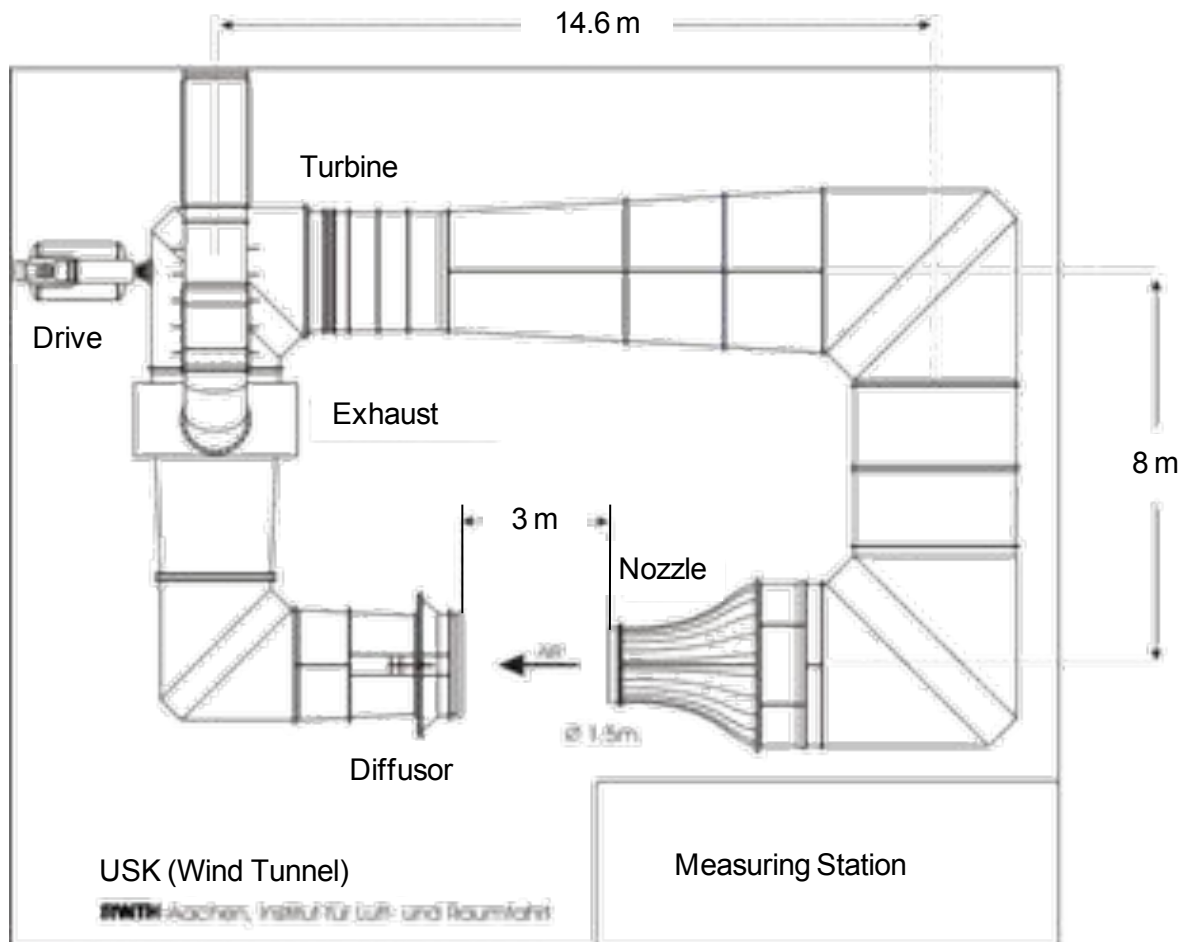


Fig. 6-25: Wind tunnel at Chair of Flight Dynamics (RWTH Aachen University)

For the wind tunnel tests physical models of the reference tractor, the optimised tractor and the trailer are manufactured in a 1:10 scale. The model is mostly made from birch multiplex wood and Ureol-plastics. Parts that are needed in multiple executions, like the tyres for example are casted from polyurethane casting resin. Fig. 6-26 shows the hardware models mounted to the test bench in the wind tunnel.

To measure the pressure forces and friction forces both models are mounted to the test bench successively. Then different air flow velocities between 20 m/s and 55 m/s are applied. A balance is used to measure the occurring forces. To reproduce realistic conditions the whole model, which means tractor and trailer, has to be fitted to the balance. At this point a simplification needs to be accepted, because the 1:10 model is too big for the balance. Therefore only the tractor is connected to the balance. It does not have any contact with the

test bench frame, so the forces in all directions can be detected by the balance. The trailer, however, is fixed to the test bench frame. This simplification is visualised in Fig. 6-27. This way the friction resistance of the trailer and the low pressure area behind the trailer is neglected, but the flow pattern of the model reproduces realistic conditions. Nevertheless, this test configuration allows measuring the difference between the two tractor concepts.



Fig. 6-26: Hardware models for wind tunnel tests



Fixed coupling between test bench frame and trailer

No contact between tractor and test bench frame

Balance

Fig. 6-27: Mounting of model with simplification

The measured results of the wind tunnel test are shown in Fig. 6-28. The c_D value is plotted against the air flow velocity. The averaged c_D value over the flow velocity is 0.625 for the reference truck and 0.427 for the advanced concept. This means a reduction 31.68 %.

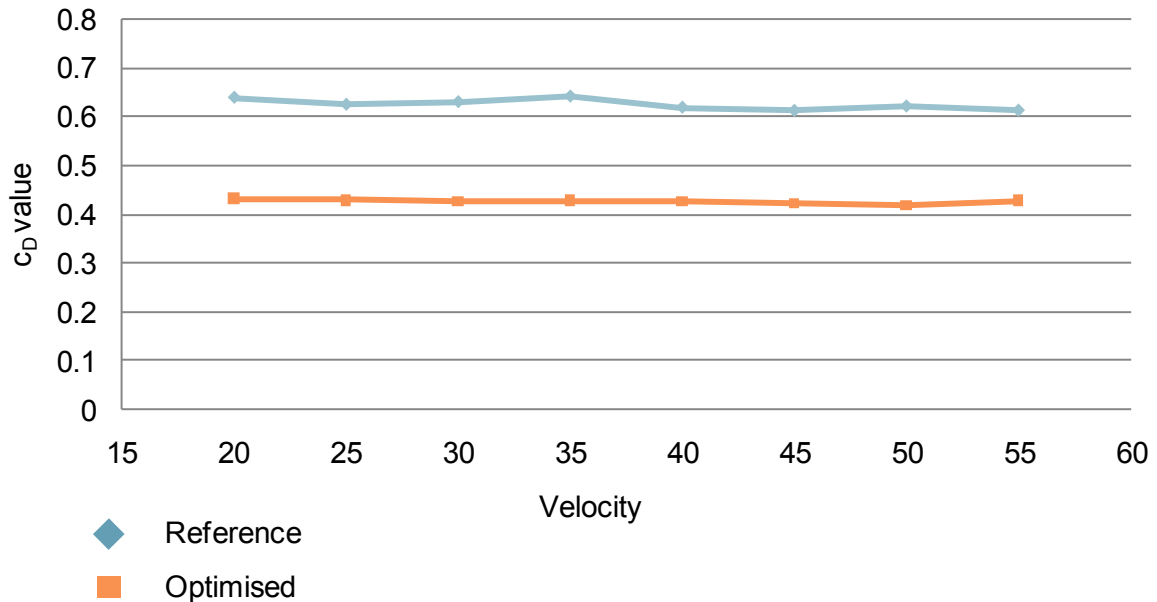


Fig. 6-28: Measured c_D values with simplified test setup (trailer fixed to test bench frame)

These results show a deviation from the simulation results. The simulations bring out a c_D value of 0.703 for the reference truck and a value of 0.618 for the advanced concept, which means a reduction of 12.11 %. The deviation between the simulation results and the test result is caused by the simplification of the measuring. Because of the disregard of the friction forces at the trailer and the low pressure area behind the trailer the measured c_D values are lower than the calculated ones.

Furthermore also the difference between the reference truck and the advanced concept is bigger in the test results than in the simulation results. Because of the simplification of the measuring only effects caused by the different front shapes of the tractor are detected. The negative influence of the usage of the same trailer for the reference truck and the advanced concept is not measured. The fact that the difference between reference truck and advanced concept is bigger when trailer effect are neglected reveals that in a reverse conclusion there is even more potential for improvement of the concept's aerodynamic properties by adapting the trailer accordingly.

To investigate the adequacy of the simulation results additional simulations are executed. In doing so the simplification of the tests are also considered in the simulation. This way a c_D value of the reference truck of 0.625 was calculated. This value shows complete consistency with the test result. The simulation result for the advanced concept reveals a c_D value of 0.439. This means a deviation of 2.81 %. Due to this good compliance of the test results with the calculated values is proven.

Besides measuring of the c_D values, analysis of the flow pattern is also executed by means of smoke plumes. An example of these investigations is shown Fig. 6-29. These tests are also documented as video files. Generally it can be seen that the streamlines show a smoother course at the advanced concept.

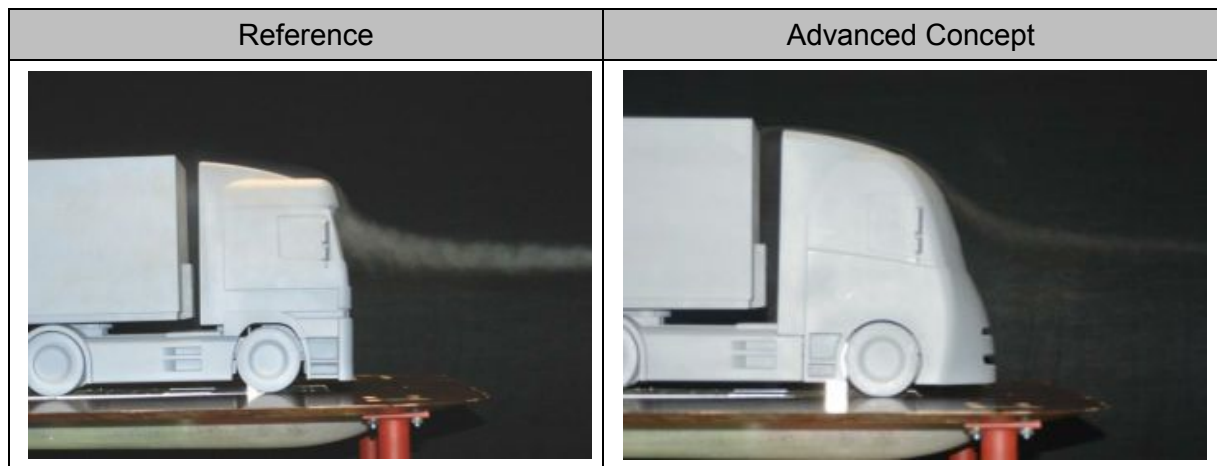


Fig. 6-29: Analysis of flow pattern with smoke plumes

6.3 Crash Simulations

Besides the aerodynamics also safety issues shall be improved by the advanced concept. For the evaluation of the passive safety performance crash simulations are executed. It cannot be assumed that the change front geometry without improving the crash structures has positive effects. For that reason a crash management system is designed in the first step. Therefore functional requirements are defined. After this, a CAD model is built up based on a topology optimisation.

To define the simulation setups, HGV accident statistics are investigated. This is followed by the execution of the simulations and the according evaluation.

6.3.1 Crash Management System

The advanced concept provides additional design space in the front area due to the length extension of the front. This space can be used to achieve an optimisation of the safety concept by adding an additional crash management system.

6.3.1.1 Definition of Functional Requirements

The crash management system should optimise the energy absorption behaviour and also serve as an underrun protection system for passenger cars. Underrun protection systems have to fulfil the requirements given in ECE-R 93. These are illustrated in subchapter 4.1.3.3. For the development of the crash management system the required dimensions are considered and the bearable force levels are checked in FE simulations.

The crashworthiness target values need to refer to the passenger car, because the accident severity will be much heavier for car occupants than for the truck occupants in case of a car to truck crash. But such values for a development of a truck crash management system cannot be found in the executed literature research. For that reason limit values for common car crash tests are investigated, because they are defined according to the physical limits of human body. Fig. 6-30 shows the EURO NCAP crash test setup. For the crash evaluation, a dummy is used. The evaluation points on this dummy are displayed in Fig. 6-31.

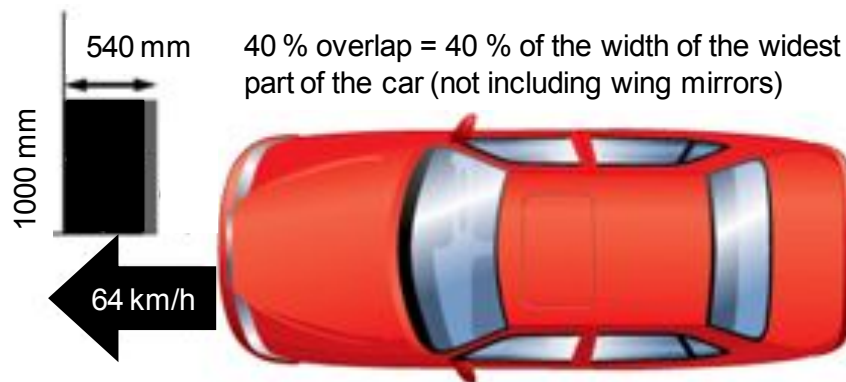


Fig. 6-30: Setup of EURO NCAP crash test [CAR11]

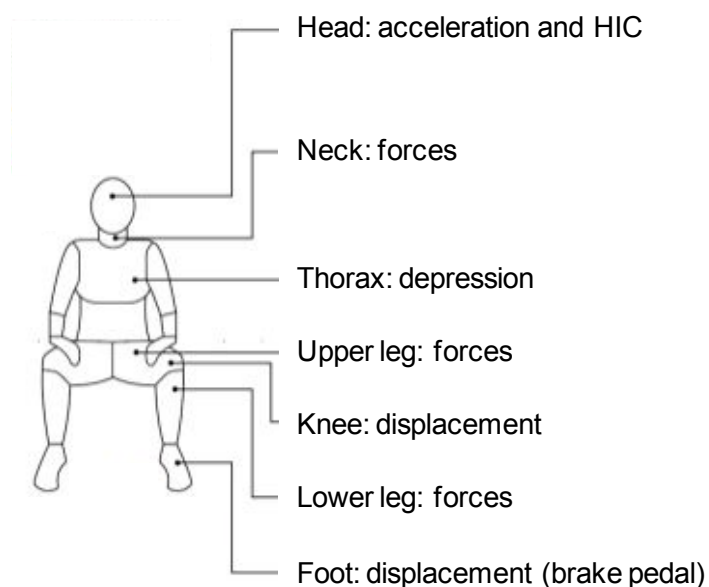


Fig. 6-31: Evaluation points on a dummy [CAR11]

The recorded values at the dummy also depend on restraining system like seat belts and airbags. These influences should not be considered for the design of a truck crash management system. Hence car related limit values are required.

Such car related values are used in the ULSAB Project. They are listed in Fig. 6-32. Only intrusion and displacements are considered in these values. But for a complete evaluation of

the accident severity the occurring accelerations need to be considered. Both of the values, intrusion and acceleration, should be as low as possible. A low acceleration can be achieved by a bigger deformation path, but this automatically leads to an increase of the intrusions. Since the human body only tolerates limited accelerations but huge intrusions also cause heavy injuries a good compromise between these values is acquired.

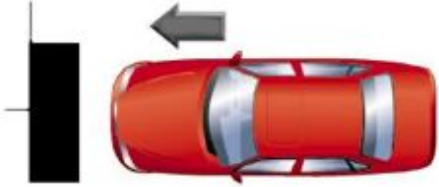

Crash Event	Crashworthiness Targets
<p data-bbox="368 555 679 589">US NCAP Front Impact</p> 	<p data-bbox="858 562 1374 595">Overall dynamic deformation ≤ 650 mm</p> <p data-bbox="858 633 1406 701">Steering column displacement ≤ 80 mm in X-direction</p>
Crash Event	Crashworthiness Targets
<p data-bbox="432 1021 612 1055">EURO NCAP</p> 	<p data-bbox="858 1025 1270 1059">A-pillar displacement < 650 mm</p> <p data-bbox="858 1097 1209 1131">Footwell intrusion < 80 mm</p> <p data-bbox="858 1169 1406 1236">Steering column displacement ≤ 80 mm in X-direction</p>

Fig. 6-32: Crashworthiness targets of ULSAB [ULS98]

Target values for intrusion are also used in the SLC project. Furthermore also maximal acceleration is considered. For this reason accelerations are recorded at the lower end of both B-pillars and at the middle tunnel. The decisive value is the average of these values. Fig. 6-33 shows the SLC target values. Adverse in the present case is that the simulation model and the evaluation of the simulation respectively have a high degree of complexity.

Due to this again the only intrusions into the car's firewall and the accelerations at the rear seat are used for the evaluation of the simulation results. Similar to the previously discussed projects also a EURO NCAP crash is the basis for the comparison. For this purpose also a EURO NCAP crash is simulated as shown in Fig. 6-34. The according intrusions and accelerations can be seen in Fig. 6-35 and Fig. 6-36 respectively.

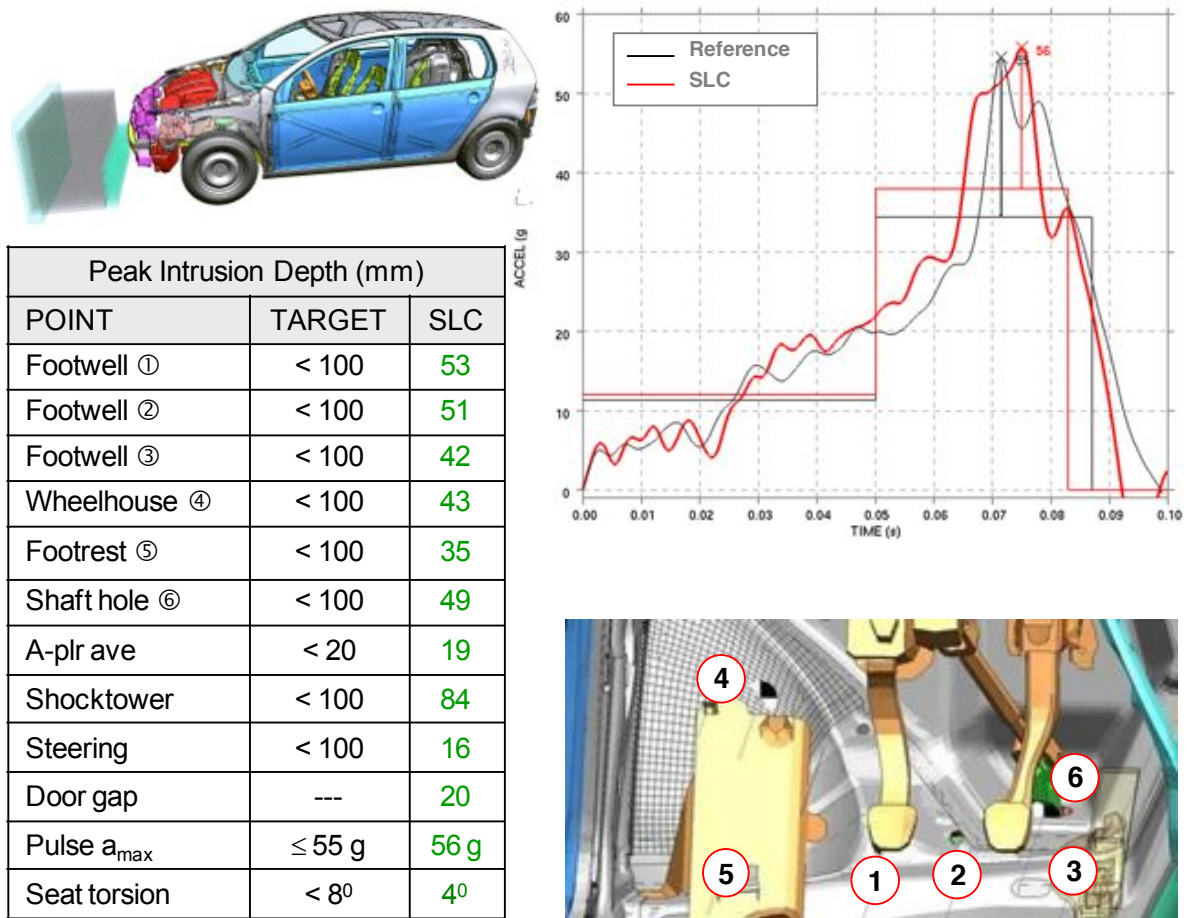


Fig. 6-33: Target values defined in SLC development [BER09]

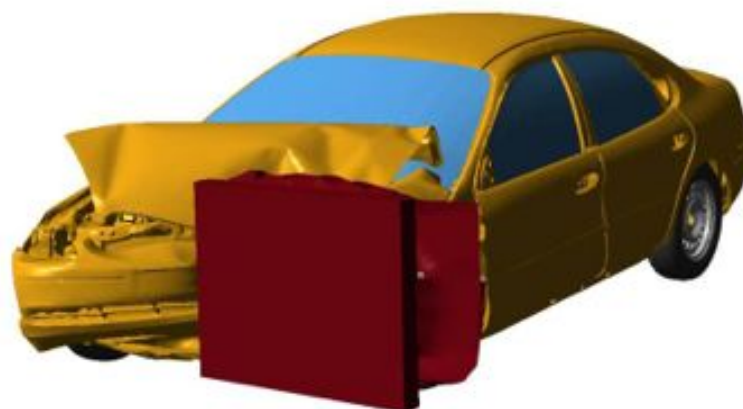


Fig. 6-34: EURO NCAP Crash

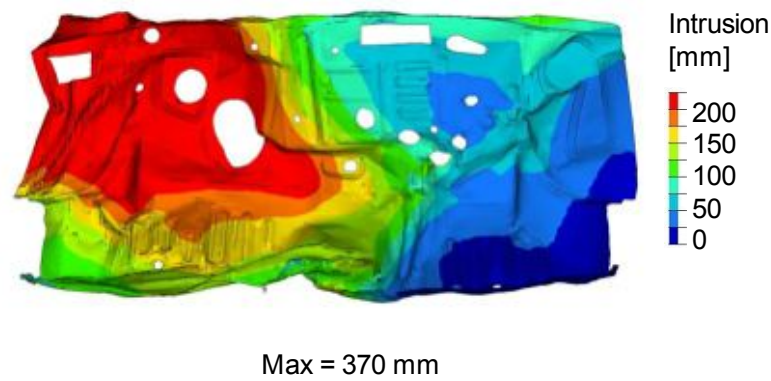


Fig. 6-35: Intrusions into the car's firewall after the EURO NCAP crash

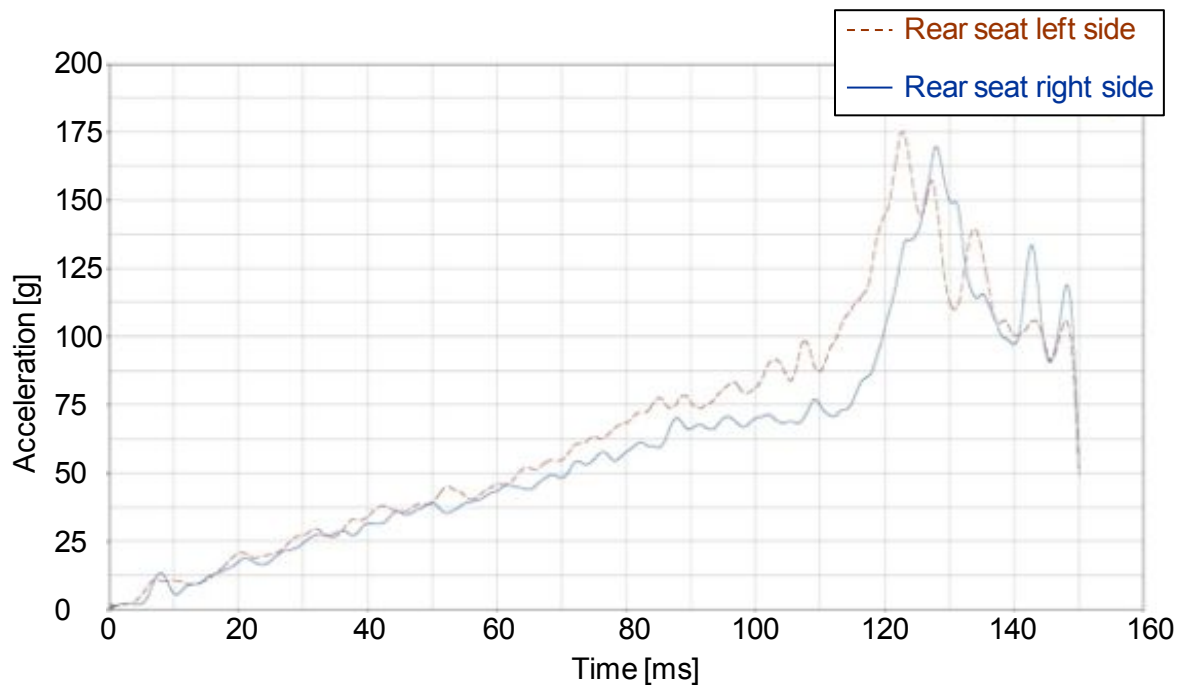


Fig. 6-36: Acceleration at the car's rear seats during the EURO NCAP crash

6.3.1.2 Concept Design

Considering the modes of deformation that energy-absorbing elements undergo, aluminium systems make it possible to absorb significantly more energy per unit of weight than traditional steel systems. As a thumb rule, the light-weighting potential exceeds 40 % [GIL04]. The higher energy absorption capacity of aluminium compared to steel is illustrated in Fig. 6-37, which shows a qualitative comparison of two different crash profiles. One of them is made from St14 steel sheet. The other one is made from an aluminium extrusion profile (AlMgSi0.5). Because of the higher force level the aluminium profile absorbs more energy than the steel profile.

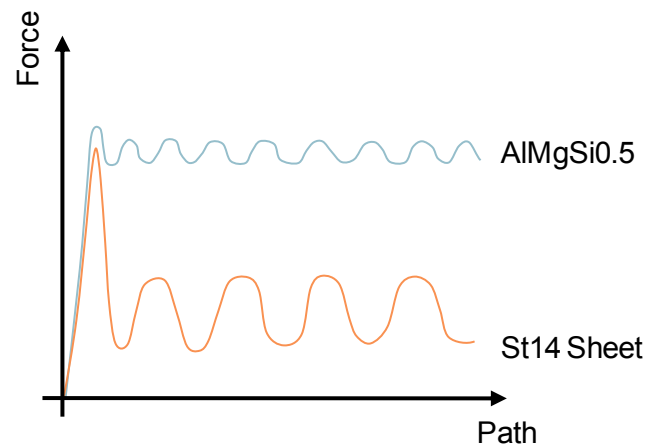


Fig. 6-37: Energy absorption of crash elements [OST92]

For that reason the usage of aluminium for crash structures in passenger cars is widely spread. The application of extruded crash bumpers with crash boxes is a common way to realise such systems. Fig. 6-38 shows an example. These systems are characterised by their high effectiveness and low complexity.



Fig. 6-38: Extruded bumper beam with crash boxes [GIL04]

To further increase the effectiveness of crash management systems honeycomb structures as shown in Fig. 6-39 can be used. The energy absorption potential of these structures is higher than of simple extrusion profiles. The disadvantages regarding the manufacturing and joining complexity however avoid a higher market penetration of this technology presently.

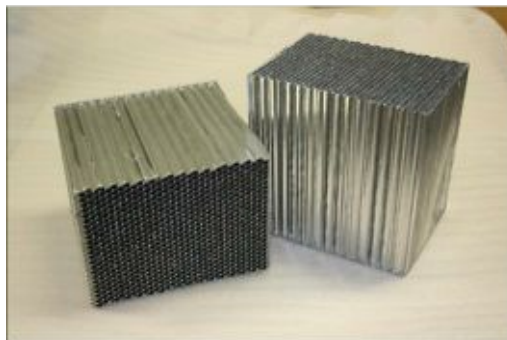


Fig. 6-39: Honeycomb structures for crash modules

Furthermore, an unconventional approach is considered. To improve the crash performance of trams transversally mounted structures are developed currently. As an example the “safetram” system is shown in Fig. 6-40. An advantage of this system is that it can face multiple accident scenarios. For example, it is designed to dampen a head-on shock at 20 km/h with an identical tramway weighing 35 t or a 45°-collision at 25 km/h with a light commercial vehicle (3 t) [GIL04].



Fig. 6-40: “Safetram” system for trains [GIL04]

The properties of the three discussed concepts are abstracted in Fig. 6-41. The concept with extruded bumper beams and crash boxes shows good performance and is a well known technology. Hence it is selected for the first approach.

	Extruded beams with crash boxes	Safetram crash module	Honeycomb structures
Effectiveness	+	o	+
Manufacturing complexity	+	+	o
Complexity of joining	+	+	-
-: moderate o: neutral +: good			

Fig. 6-41: Assessment of possible crash management systems

To assign the optimal structural shape for the crash management system a topology optimisation of the free space is executed. Pictures of the topology optimisation are shown in Fig. 6-42.

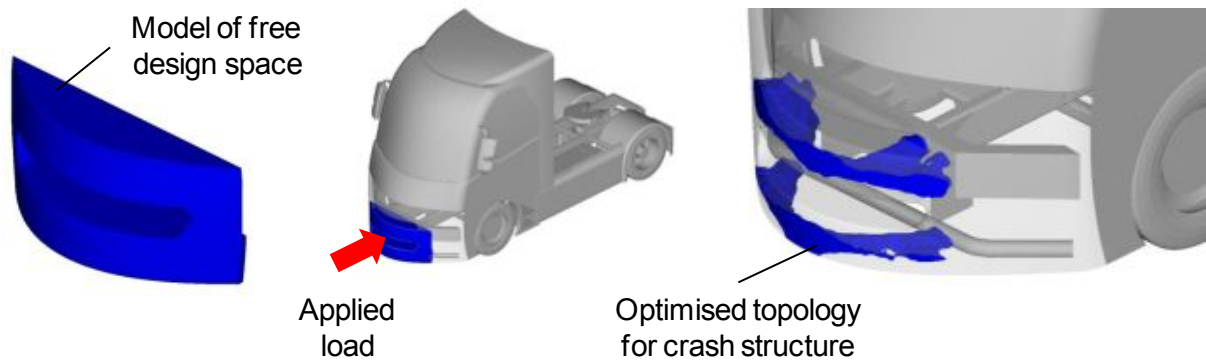


Fig. 6-42: Topology optimisation of free design space

The results of the topology optimisation are interpreted as illustrated in Fig. 6-43. The upper crash bumper improves the self protection performance. The lower bumper serves as an underrun protection device. The additional two vertical beams are added to consider different bumper heights of possible accident opponents. This way the partner protection performance is enhanced.

To avoid redundancy of bumper systems the original steel bumper is omitted. Furthermore the lateral parts of the steel bumper are integrated into the crash management system as illustrated in Fig. 6-43.

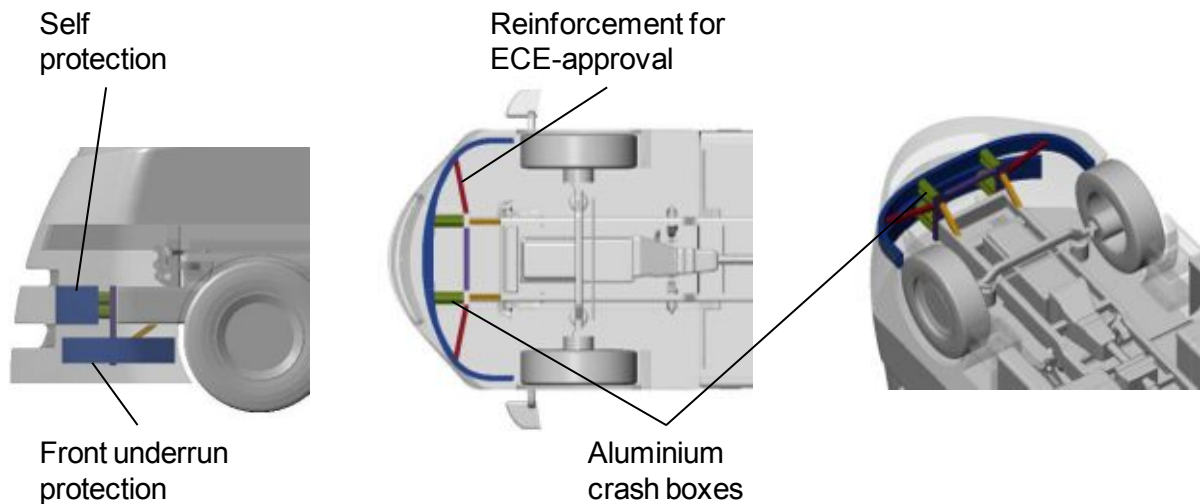


Fig. 6-43: Additional aluminium crash management system

6.3.1.3 ECE-R 93 Test

To check the requirements given in ECE-R 93 the simulation model shown in Fig. 6-44 is build up. The defined forces are applied on the prescribed test points. The force curves in Fig. 6-45 show that the underrun protection device is able to withstand the defined forces without plastic deformation.

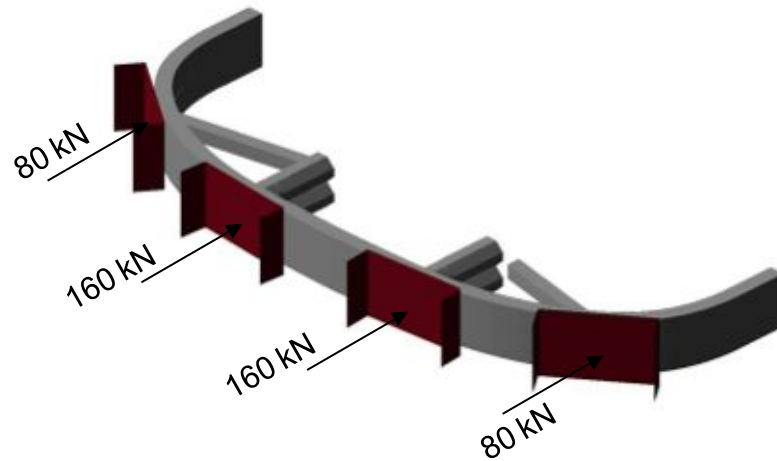


Fig. 6-44: Test configuration (ECE-R 93)

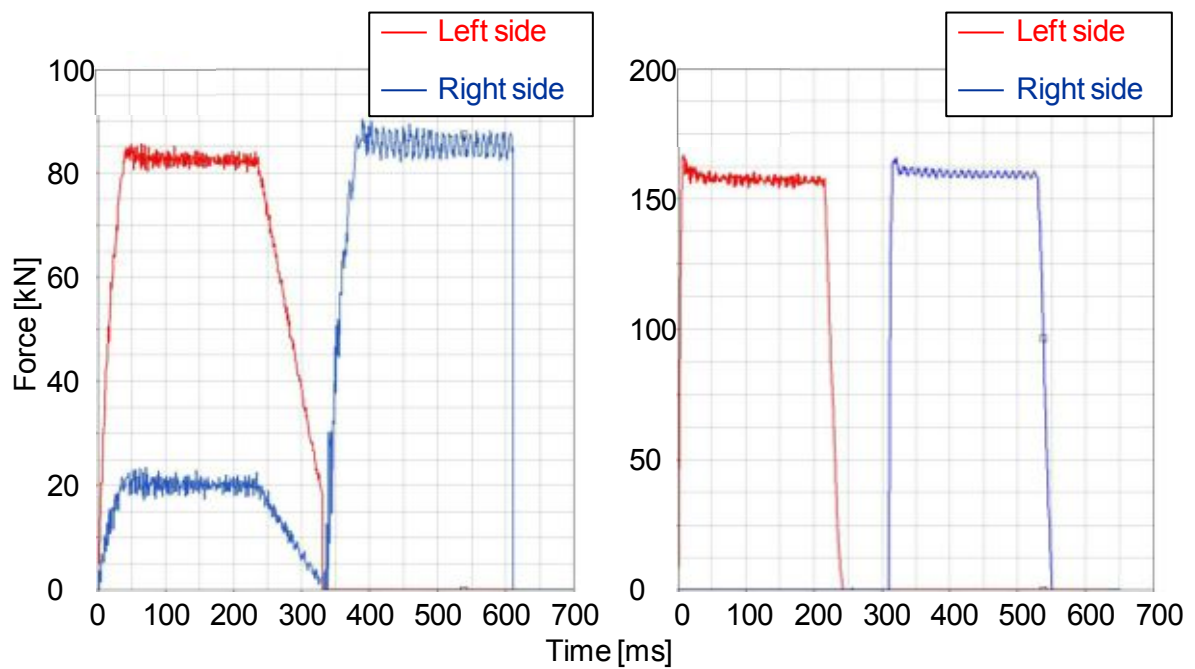


Fig. 6-45: Force levels

6.3.2 Definition of Representative Crash Simulation Setups

To define simulation setups HGV accident statistics are investigated to find out the most significant accident scenarios.

6.3.2.1 HGV Accident Statistics

The crash structure of the tractor shall serve for self-protection and for partner protection. The following section will analyse available statistics to determine typical accident scenarios involving the frontal structure of a truck and derive affected relevant target population of road

user categories. The statistical findings serve to select the crash simulation setups that best characterise the passive safety performance.

To identify the target population, the number of fatalities in different accident scenarios is estimated. The total number of fatalities with involvement of HGVs in 2008 is estimated at 7070 in a study executed by TRL based on road casualty numbers for the EU-27 countries [TRL10].

The distribution of fatalities in accidents with involvement of HGVs on the different types of road users is shown in Fig. 6-46. These values apply for the EU18 countries. They are considered to be representative, so they can be scaled to execute coarse estimations for Europe. In association with the total amount of 7070 fatalities per year, the numbers of car occupants, truck drivers and VRUs killed in accidents with HGV involvement can be estimated. This method yields 1555 killed VRUs, 3535 car occupants and 989 truck drivers per year.

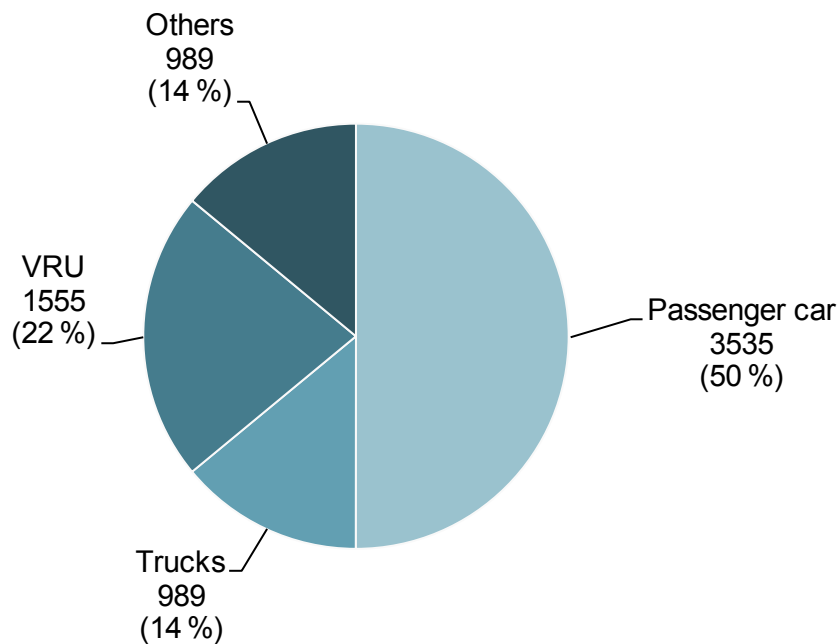


Fig. 6-46: Distribution of fatalities with HGV involvement [ERS08]

The relevant target population consists of those fatally injured road users that are hit by the front of the truck. Fig. 6-47 shows distributions of killed and severely injured (KIS) VRUs in prominent accident scenarios determined by four different authorities. Assuming that these values are representative and the percentages of killed and severely injured people are analogue to shares of fatalities, the number of VRUs killed in the different scenarios can be determined.






	Description	Typical situation	Volvo [%]	Cidaut [%]	DEKRA [%]	IVECO [%]
Scenario 1	HGV front vs. VRU when taking off		10	38	26	7
Scenario 2	HGV vs. VRU when reversing		20		4	20
Scenario 3	HGV vs. VRU crossing road		20	24	9	27
Scenario 4	HGV side vs. VRU when turning		20		26	18
Scenario 5	HGV rear vs. unprotected, driving straight		10	13	22	13
Others	Others	-	-	25	13	15

Fig. 6-47: Killed and severely injured VRUs in prominent HGV-VRU scenarios [HDV05]

In scenario 1 and scenario 3 the VRUs involved in one of these scenarios can benefit from the developed front design. For all other scenarios a mitigation of the accident consequences cannot be expected.

In a pessimistic estimation the total number of involved VRUs in scenario 1 and scenario 3 can be calculated according to Eq. 6-8. An optimistic estimation is determined in Eq. 6-9. The percentages for each scenario determined by one authority are summed up. The minimum sum is used for the optimistic estimation; the maximum sum is used for the pessimistic estimation. In this context the pessimistic estimation leads to a higher number of fatalities, but in a reverse conclusion also a higher benefit is generated by the advanced concept that way. This approach shows that a number from 467 to 544 VRUs can benefit from the developed front design.

$$1555 \cdot (10 + 20)\% \approx 467 \quad \text{Eq. 6-8}$$

$$1555 \cdot (26 + 9)\% \approx 544 \quad \text{Eq. 6-9}$$

An analogue investigation is also executed for car occupants. Fig. 6-48 shows the distribution of killed and severely injured car occupants in prominent accident scenarios. The car is hit by the front of the truck in the scenarios 1, 2, 3 and 5. For these cases positive effects for the car occupants are expectable caused by the optimised truck front design. The pessimistic estimation is determined in Eq. 6-10. The value for the optimistic estimation is calculated in Eq. 6-11.

$$3535 \cdot (19 + 19 + 16 + 6)\% \approx 2121 \quad \text{Eq. 6-10}$$

$$3535 \cdot (30 + 5 + 15 + 15)\% \approx 2298 \quad \text{Eq. 6-11}$$

The percentages for the killed and severely injured HGV occupants in prominent collisions scenarios are illustrated in Fig. 6-49. An optimised frontal structure can yield positive effects for scenario 3, Scenario 4 scenario 5 and - with some limitations - scenario 1. In these scenarios the truck front gets or could get in contact with an obstacle. Analogue to the previous calculations a number from 613 to 989 killed HGV occupants is determined in Eq. 6-12 and Eq. 6-13.

$$989 \cdot (52 + 2 + 6 + 2)\% \approx 613 \quad \text{Eq. 6-12}$$

$$989 \cdot (21 + 79)\% \approx 989 \quad \text{Eq. 6-13}$$








	Description	Typical situation	Volvo [%]	Cidaut [%]	DEKRA [%]	IVECO [%]
Scenario 1	Oncoming traffic HGV front vs. car front		30	19	19	21
Scenario 2	Oncoming traffic HGV front vs. car side		5	27	19	11
Scenario 3	Traffic ahead in same direction HGV front vs. car rear		15	15	16	11
Scenario 4	Traffic ahead in same direction car front vs. HGV rear		12		6	10
Scenario 5	Intersection HGV front vs. car side		15	1	6	18
Scenario 6	Intersection car front vs. HGV side		12		13	9
Scenario 7	Lane change accident HGV side vs. car side		10	7	6	9
Others	Others	-		32	15	11

Fig. 6-48: KSI passenger car occupants in prominent HGV-car collisions [HDV05]

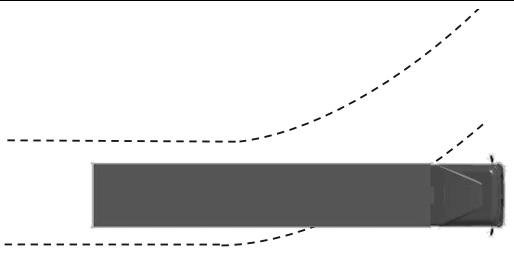
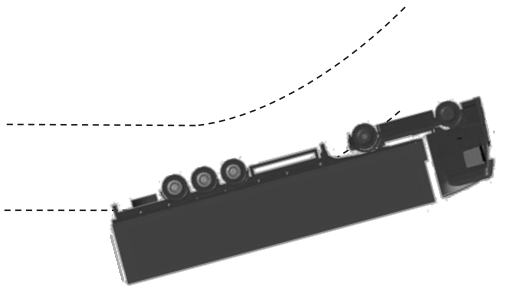
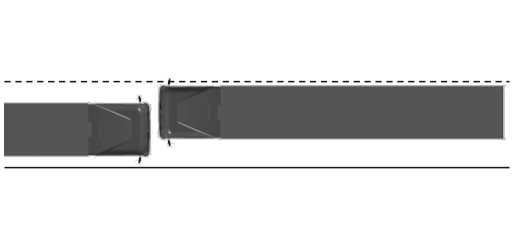
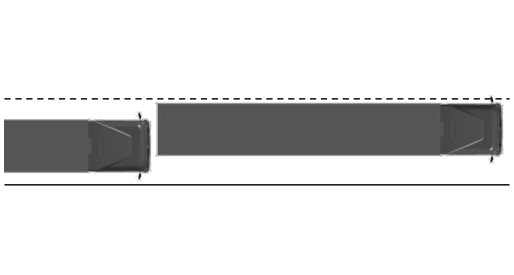
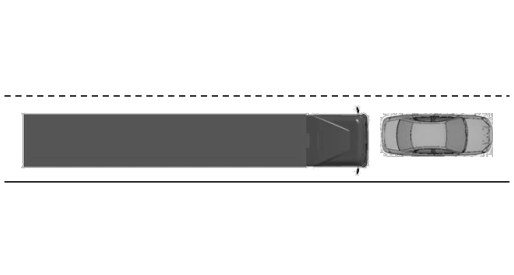
	Description	Typical situation	Volvo [%]	Cidaut [%]	DEKRA [%]	IVECO [%]
Scenario 1	HGV single driving off road		35	52	21	30
Scenario 2	HGV single rollover on road		12	8	0	11
Scenario 3	HGV - HGV collision, oncoming traffic front vs. front		10	2	0	13
Scenario 4	HGV - HGV collision, traffic ahead in same direction front vs. rear		20	6	79	25
Scenario 5	HGV - passenger car collision, oncoming traffic, HGV front vs. car		10	2	0	2
Others	Others	-		24		19

Fig. 6-49: Killed and severely injured HGV occupants in prominent collisions [HDV05]

These statistical findings suggest defining a set of crash simulation runs.

6.3.2.2 Passenger Car Occupant Protection

For the definition of simulation setups for the analysis of the car occupant protection performance only those scenarios from the statistical findings are considered, in which the truck front has contact to the accident opponent. These are the scenarios 1, 2, 3 and 5. The biggest percentages can be covered with simulation configurations representing a frontal crash and a rear shunt. In frontal accidents an offset between the car and the truck often occurs, because the two accidents opponents are approaching on different sides of the road. Hence two simulation setups are considered for the front crash: One without offset and one with an offset of 30 %. As an example the simulation setup for the offset crash can be seen in Fig. 6-51 and Fig. 6-52. To represent scenario 3 rear shunt simulations with two different impact velocities are executed. In these setups the car is standing and the truck has an impact speed of 20 km/h and 40 km/h respectively.

The frontal collision setup with 30 % offset is also used by DEKRA to evaluate the partner protection performance of trucks as shown in Fig. 6-50. In this car crash test configuration the truck has a velocity of 21 km/h. The passenger car's speed is 42 km/h [DEK10]. These velocity values represent a typical intra-urban accident scenario. Hence the same values are used for the simulation setup.



Fig. 6-50: DEKRA truck against car crash test [DEK10]

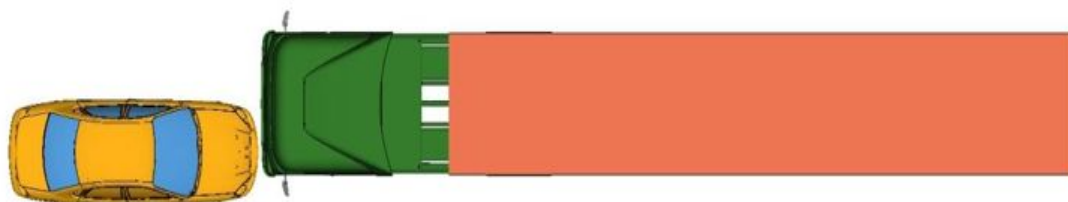


Fig. 6-51: Simulation configuration in top view



Fig. 6-52: Simulation configuration in isometric view

Crash test with similar configuration are also executed by truck manufacturers. Volvo for example completes a crash test illustrated in Fig. 6-53 to develop the Front Underride Protection System (FUPS). The truck has a velocity of 65 km/h and hits the car with 50 % offset. The target of this crash test is to identify the crash performance of the tractor using a FUPS. Therefore the energy absorption behaviour is evaluated [VOL10c].

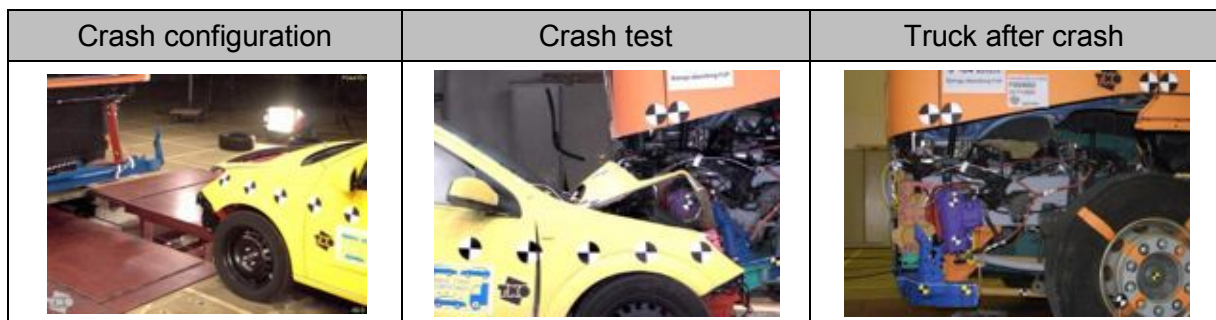


Fig. 6-53: Volvo truck against car crash test [SCH06]

In addition this crash tests is completed with different velocities of the car (56 km/h, 64 km/h and 75 km/h) and with different kinds of cars (super mini and small family). So it is possible to design the FUPS for different crash severities [VOL10c]. Further information about the FUPS can be found in [UTA05].

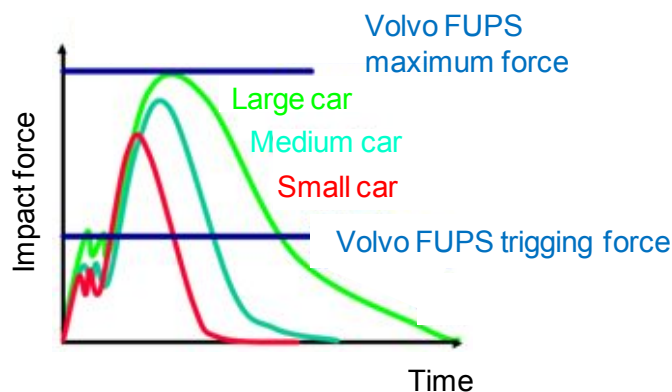


Fig. 6-54: Results of Volvo crash test [VOL10c]

6.3.2.3 VRU Protection

For the evaluation the VRU protection characteristics of the advanced concept in comparison to the reference truck, several simulations are completed. The design changes of the advanced concept are limited to the front of the truck. Hence the VRU is hit by the front of the truck in the simulation setup. To represent a big percentage of all fatal VRU accidents found in the accident statistics, two different impact zones are considered for both of the concepts as shown in Fig. 6-55.

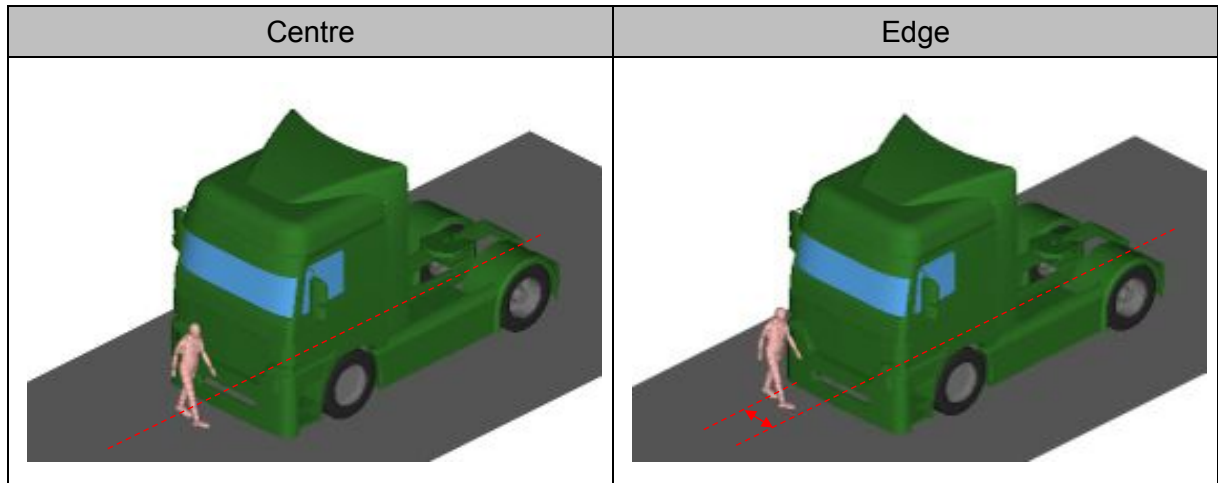


Fig. 6-55: Consideration of two different impact zones

For each impact zone several human body models are investigated. These are:

- 6 year old child
- 5 % female
- 50 % male
- 95 % male
- Cyclist

The percentages in the declaration of the model indicate how many percent of the female or male population fall below the size of the respective model according to statistics.

The effect on VRU protection performance is identified by analysing the crash kinematics. An example of the dummy kinematics of a 50 % male hitting a light duty truck in straight forward driving with 40 km/h is shown in Fig. 6-56. The evaluation of the VRU protection behaviour of the new concept is based on this scenario [HAM09]. An example of the vehicle front model (multi-body model) in a pedestrian accident scenario is shown in Fig. 6-56.



Fig. 6-56: Kinematics of the 50 % male in the straight forward driving situation [FAS08]

6.3.2.4 Self Protection

For the evaluation of the self protection performance scenario 1 and scenario 4 in Fig. 6-49 represent the biggest percentages of fatal accidents. Since the critical obstacle in scenario 1 cannot be identified, scenario 4 is used for the build up of a simulation setup.

This configuration is also used by truck manufacturers. A crash test executed by MAN is shown in Fig. 6-57. The truck hits a barrier with a velocity of 30 km/h and an offset of 50 % between truck and barrier. The deformable barrier has a weight of 20 t. The target is to identify the intrusion and the energy absorption behaviour of the tractor's structure. Additionally the evacuation behaviour to rescue the driver is evaluated. Especially the cabin is tested with this crash configuration.

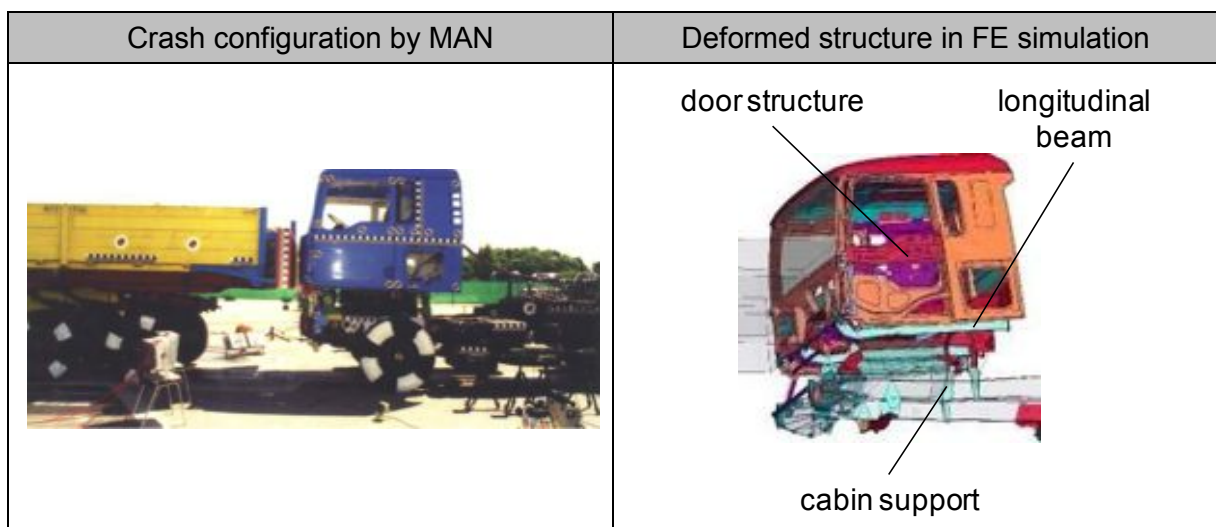


Fig. 6-57: Crash configuration by MAN [BAC09]

Volvo is completing similar crash tests against an 850 t heavy steel block barrier with an angle of 30°. This configuration can be seen in Fig. 6-58. The truck has a velocity of 30 km/h. This test corresponds to a 50 km/h crash into the rear of a trailer. Again the target is to identify of the energy absorption, cabin strength, cabin attachment and the evacuation behaviour of the cabin structure. In addition occupant injuries are evaluated [VTN09].

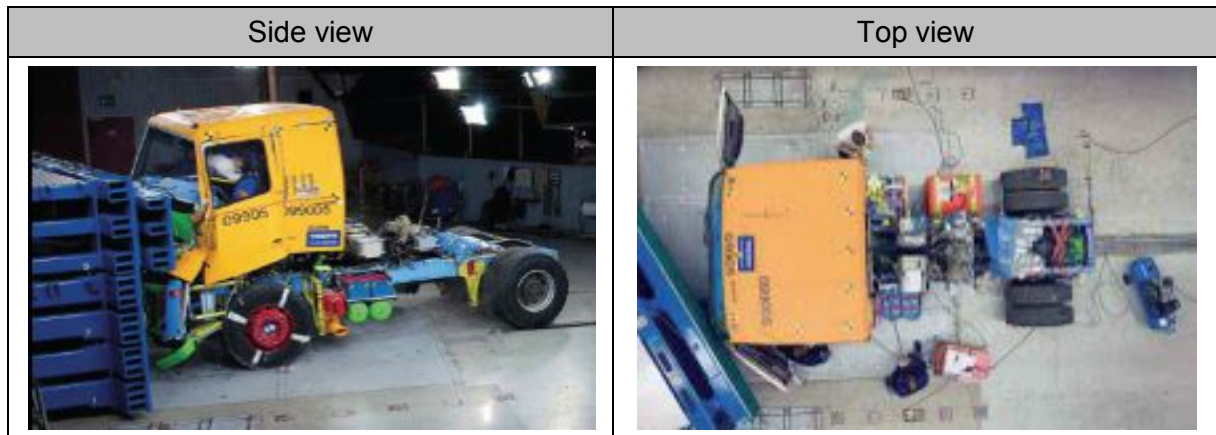


Fig. 6-58: Crash configuration by Volvo [VTN09]

For the FE simulations of the self-protection tests in this study, the tractor hits a semi-trailer with a velocity of 30 km/h and an offset of 50 % between truck and the trailer. The crash performance is evaluated by analysis of the intrusions and the energy absorption behaviour. The FE model configuration used for the simulations can be seen in Fig. 6-60 and Fig. 6-59.



Fig. 6-59: Simulation configuration in top view

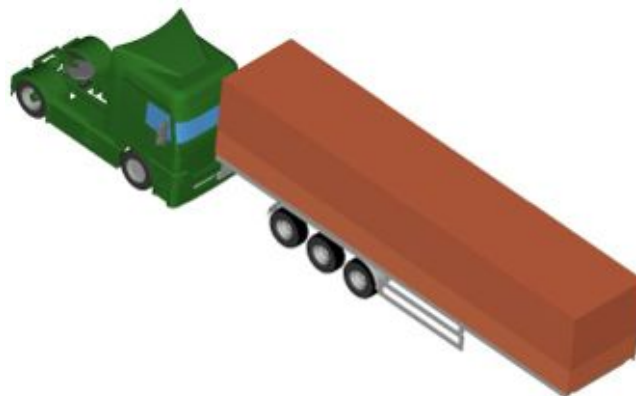


Fig. 6-60: Simulation configuration in isometric view

6.3.3 Results of Crash Simulations

The results of the crash simulations are presented in the following.

6.3.3.1 Comparison of Partner Protection Performance

As an example the simulation results for the frontal collision with 30 % offset are investigated. The recorded data for all other car to truck simulations can be seen in subchapter 13.2 of the appendix.

The comparison of the simulation results of the reference truck and the advanced concept are shown in Fig. 6-61.

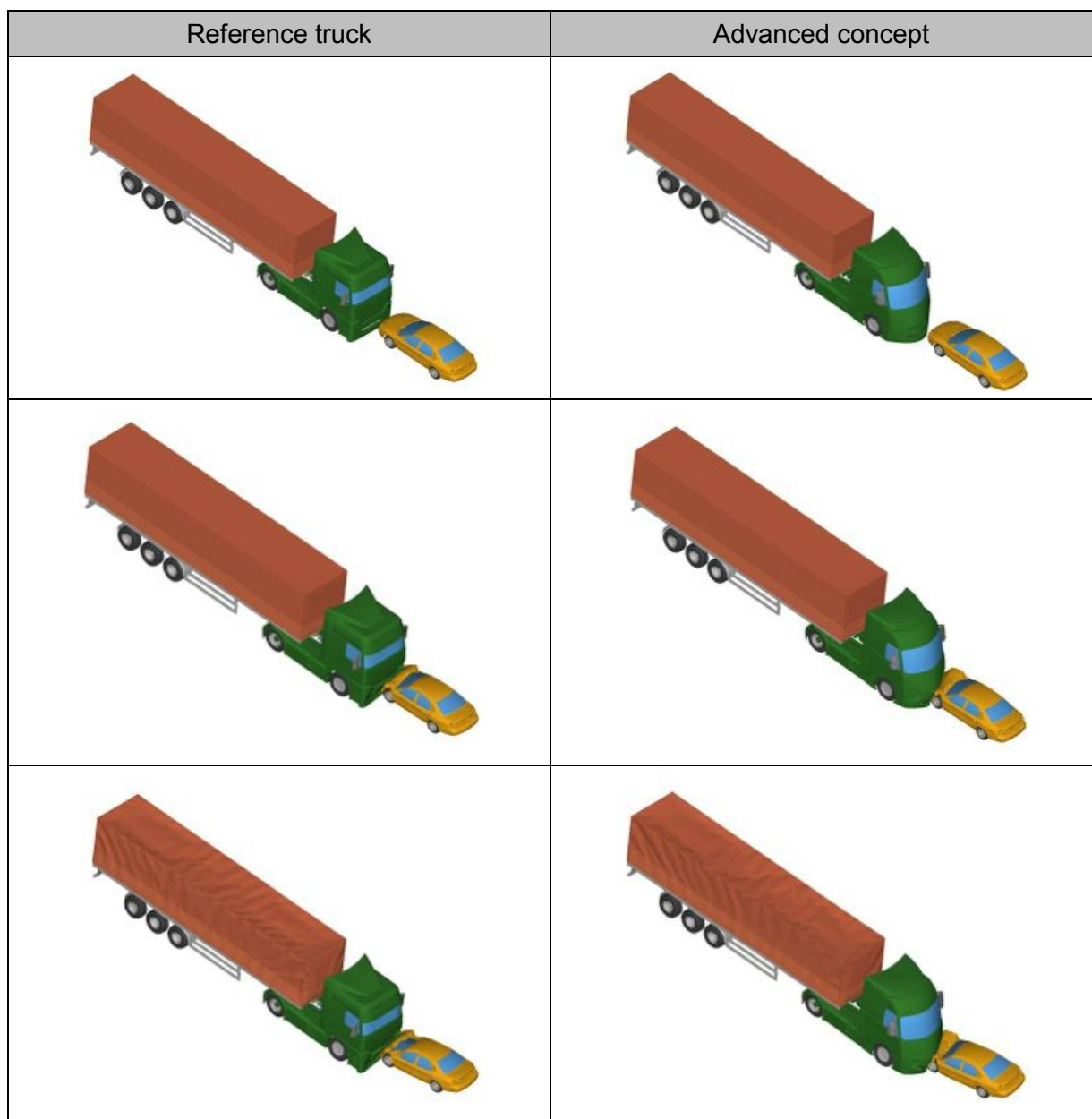


Fig. 6-61: Simulation results with additional crash management system

The evaluation of the intrusions and the occurring accelerations show differences in the crash behaviour. These data are illustrated in Fig. 6-62, Fig. 6-63 and Fig. 6-64.

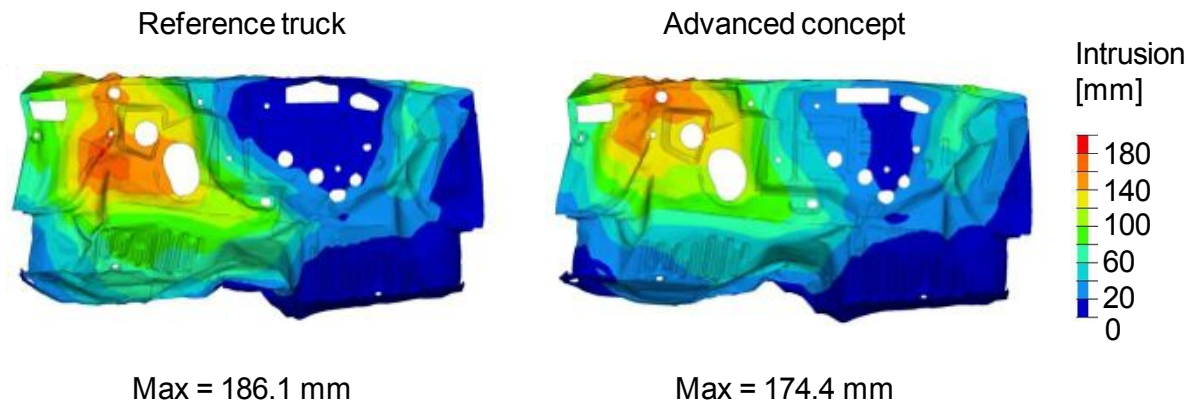


Fig. 6-62: Intrusions into the car's firewall after the crash

The maximum intrusion into the car's firewall after the crash with the reference truck is 186.1 mm. After the crash with the advanced concept the peak value is 174.4 mm. Furthermore the advanced concept shows reduced values in the steering wheel area. This area is critical, because intrusions here can easily cause contact between the car occupant parts of the car which increase the risk of injuries.

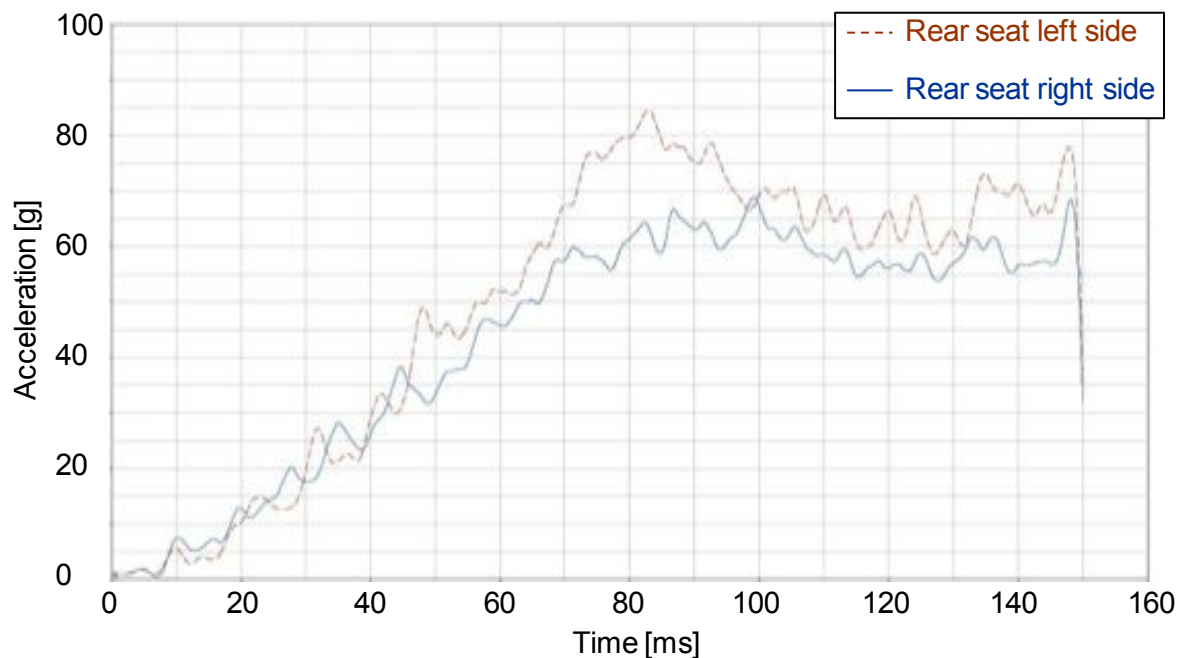


Fig. 6-63: Acceleration at the car's rear seats during crash with reference truck

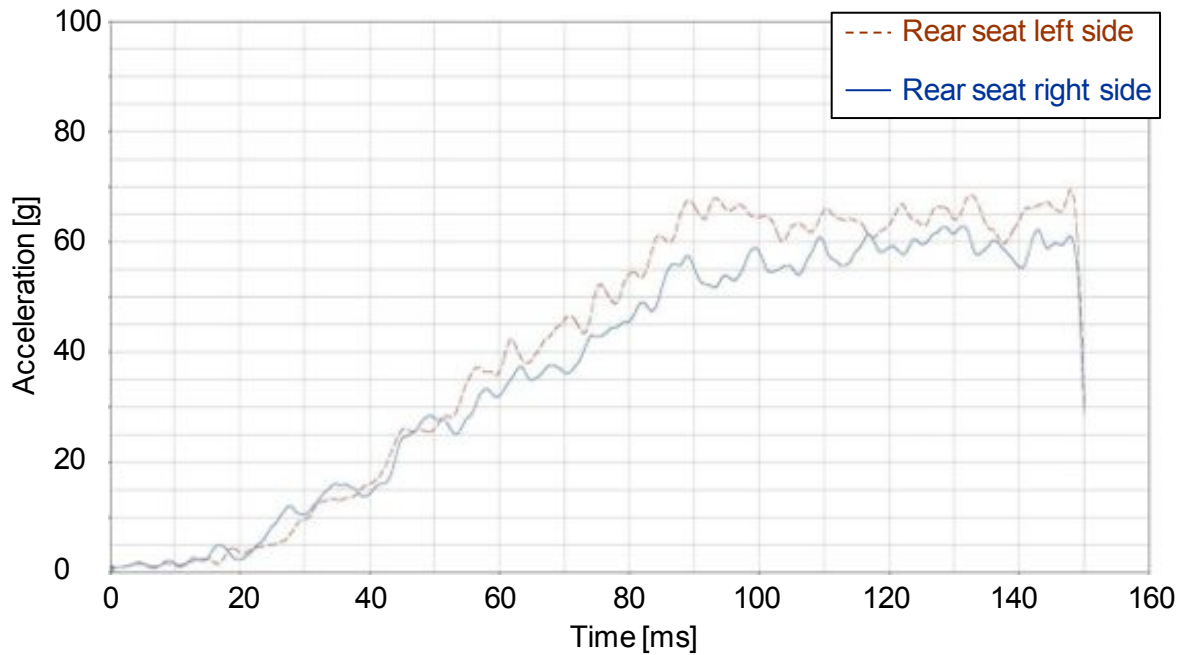


Fig. 6-64: Acceleration at the car's rear seats during crash with the advanced concept

Analysing the accelerations it becomes conspicuous that the application of the crash management system leads to a reduced peak value below 70 g (compared to 85 g for the reference truck). In conclusion, the partner protection performance is enhanced.

To evaluate the trucks behaviour during the crash the forces inside the side members are investigated. Fig. 6-65 shows the evaluation points for the recording of the occurring forces. The results are shown in Fig. 6-66 and Fig. 6-67.

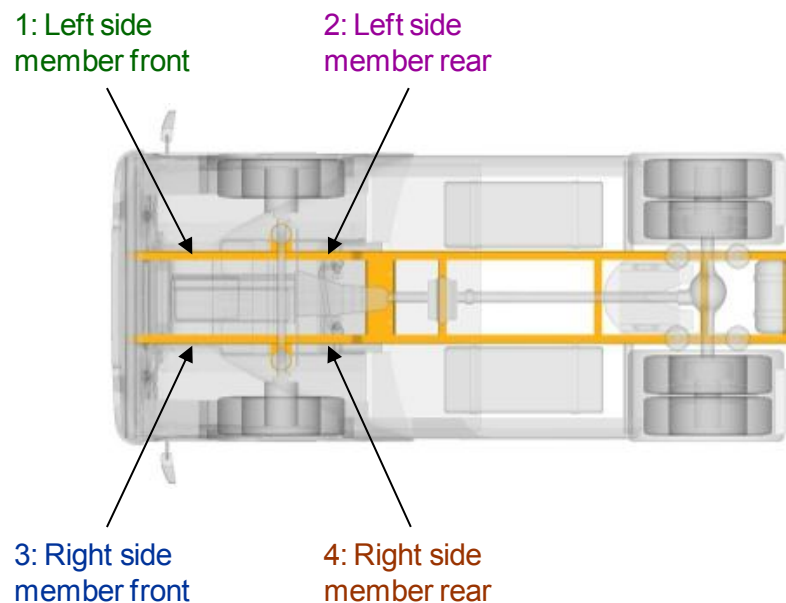


Fig. 6-65: Evaluation points for occurring forces

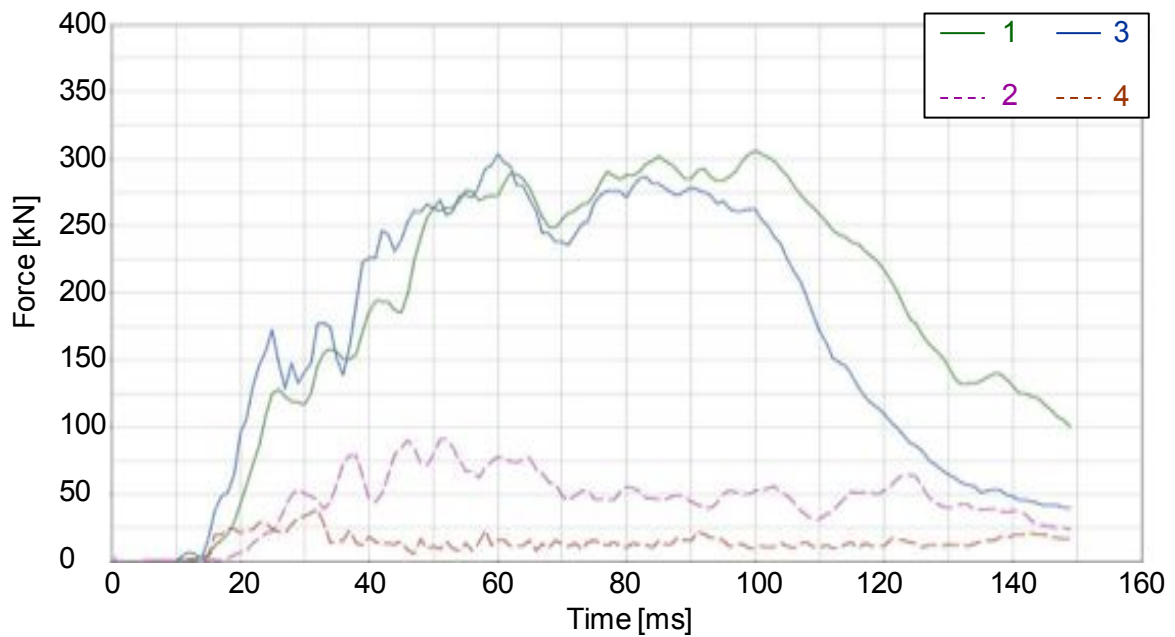


Fig. 6-66: Forces in the side members of the reference tractor during the crash

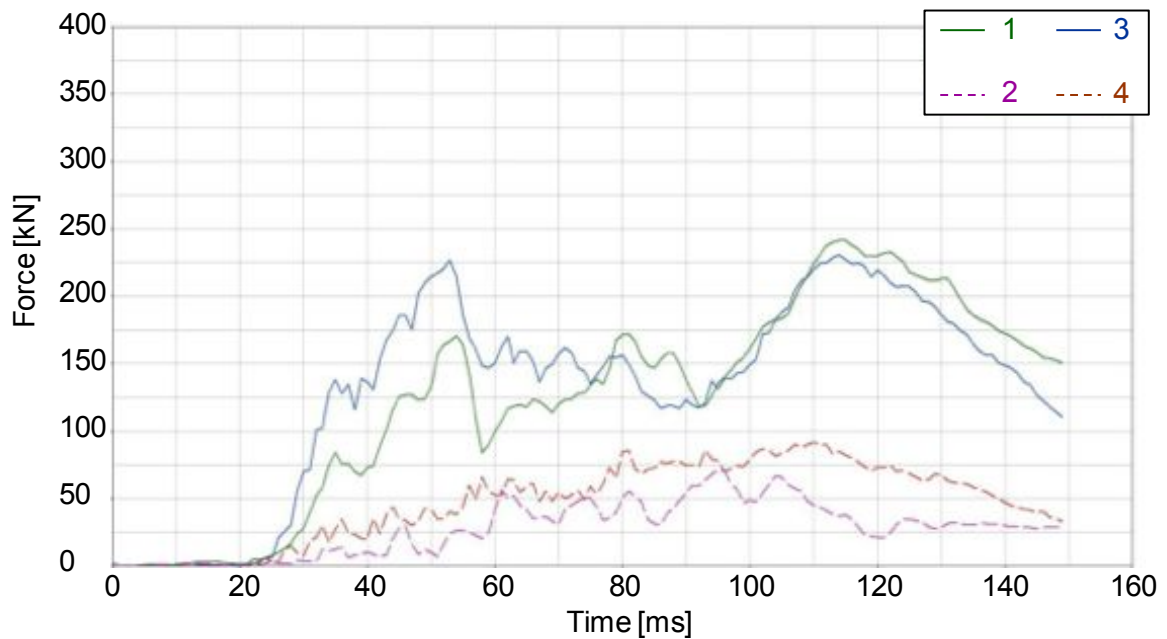


Fig. 6-67: Forces in the side members of the advanced concept during the crash

The evaluation of the forces in the side members of the truck shows that the forces are reduced. This way the self protection performance is improved.

To further clarify the positive effects of the crash management system the different amounts of absorbed energy are shown in Fig. 6-68 and Fig. 6-69. It can be seen that the share of

energy absorbed by the car is reduced in case of the advanced concept with crash management system compared to the reference truck.

The investigations show that the application of the crash management system can reduce the accident severity. Hence all further simulations are executed for the advanced concept with crash management system.

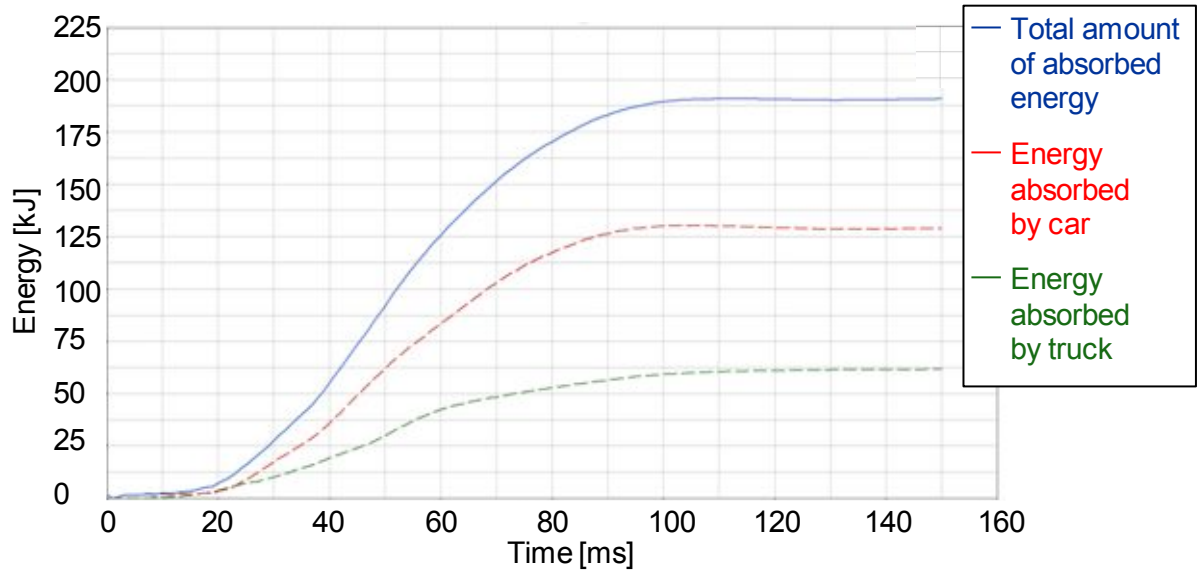


Fig. 6-68: Energy absorption behaviour of reference truck

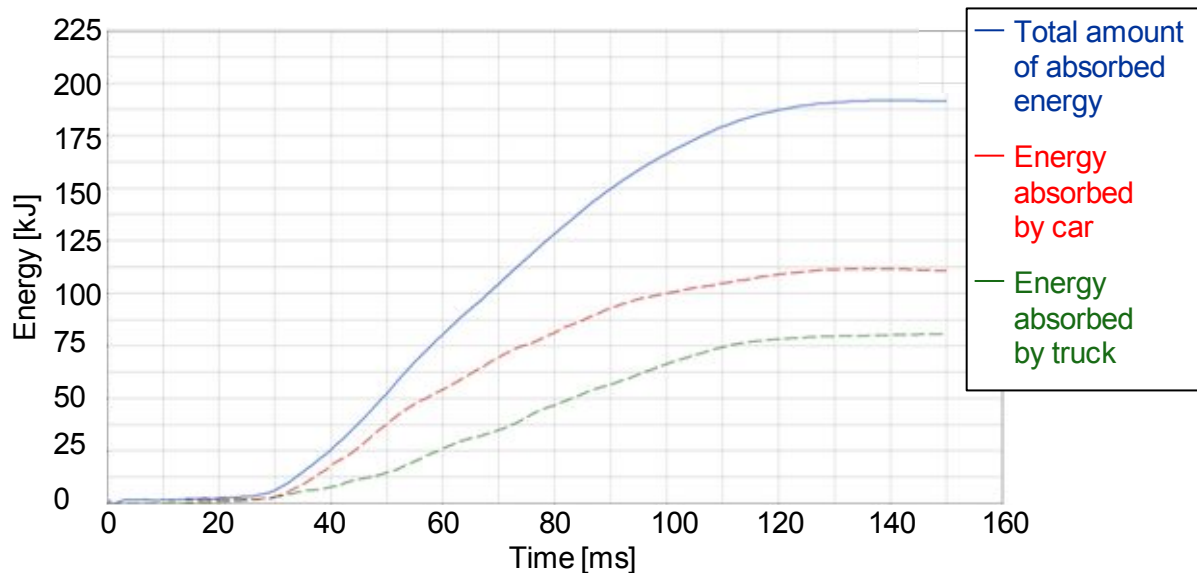


Fig. 6-69: Energy absorption behaviour of advanced concept

In Fig. 6-70, Fig. 6-71 and Fig. 6-72 the maximum values of all partner protection simulations are contrasted. All according figures can be seen in subchapter 13.2 of the appendix. It can be seen that except for one value all values have improved, so a mitigation of the accident

severity can be assumed for these cases. A more detailed investigation of the intrusion in the frontal crash without offset is illustrated in Fig. 6-72. It reveals that the maximum value of intrusion only occurs in a small area on the upper right side. The intrusions in the critical steering wheel area and the rest of the firewall however are reduced.

Frontal crash with offset	Reference truck	Advanced concept
max. intrusions into the car's firewall [mm]	186.1	174.4
max. acceleration [g]	85	70
max. force in side member [kN]	305	240

Fig. 6-70: Comparison of maximum values for frontal crash with offset

Frontal crash without offset	Reference truck	Advanced concept
max. intrusions into the car's firewall [mm]	175.9	187.3
max. acceleration [g]	250	112.5
max. force in side member [kN]	427	235

Fig. 6-71: Comparison of maximum values for frontal crash without offset

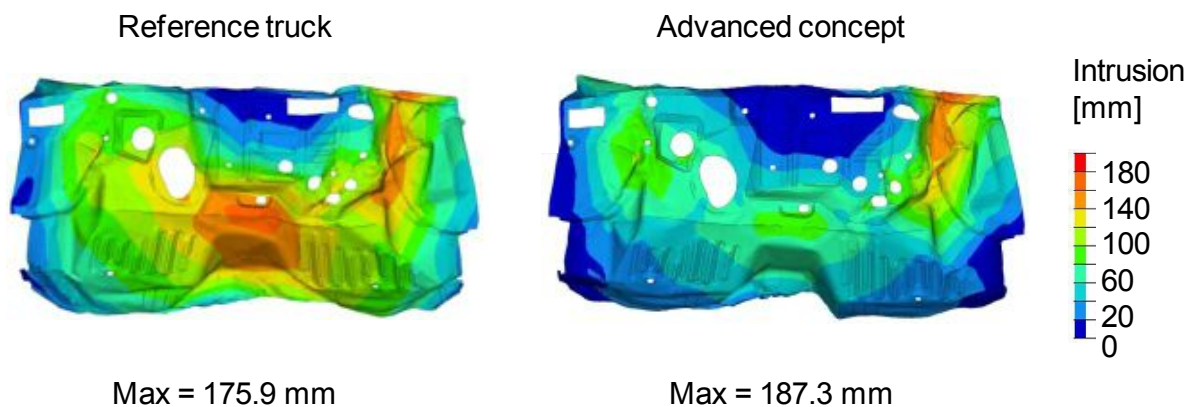


Fig. 6-72: Intrusions into the car's firewall after frontal crash without offset

Rear shunt	Reference truck	Advanced concept
max. intrusions into the car's rear floor panel [mm]	-80.2	-34.8
max. acceleration [g]	170	59
max. force in side member [kN]	90	74

Fig. 6-73: Comparison of maximum values for rear shunt

6.3.3.2 Comparison of VRU Protection Performance

As an example the result of one VRU protection simulation for the reference tractor is shown in the picture sequence in Fig. 6-74. In comparison to this the results for the advanced concept using the same configuration is illustrated in Fig. 6-75.

It can be seen that the reference tractor overruns the human model. In contrast, the advanced concept deflects the pedestrian away from the truck after the initial contact. This way the overrun is prevented. Picture sequences of all further VRU protection simulations can be seen in subchapter 13.2.

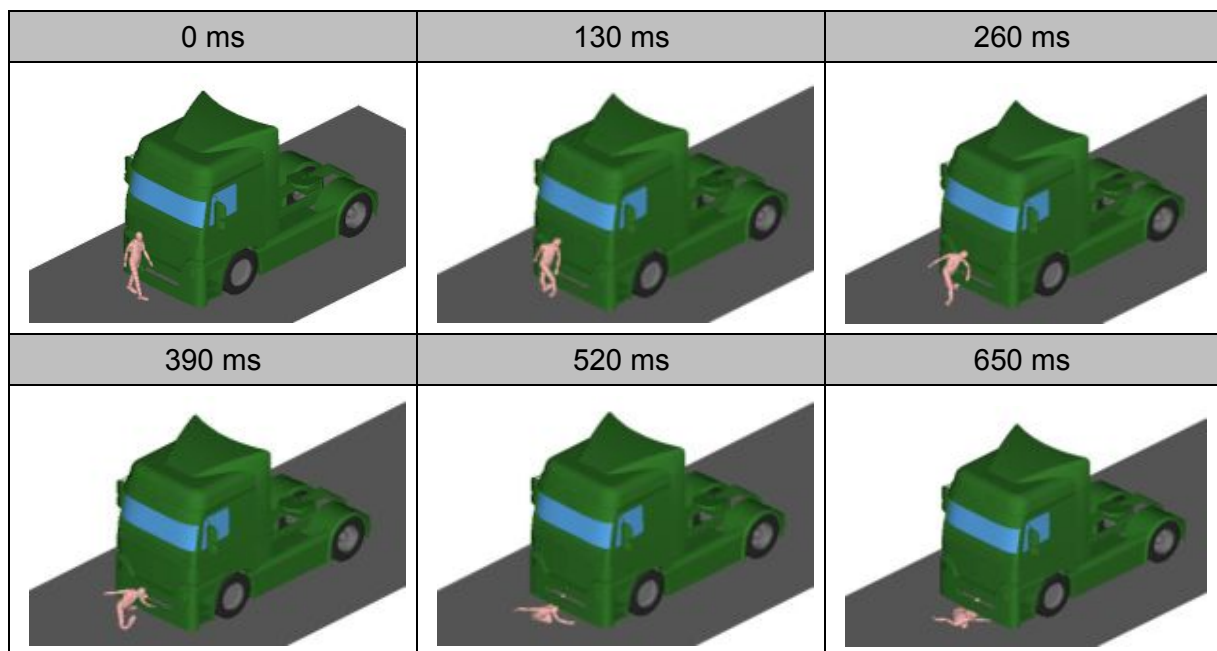


Fig. 6-74: Reference tractor against 50 % male

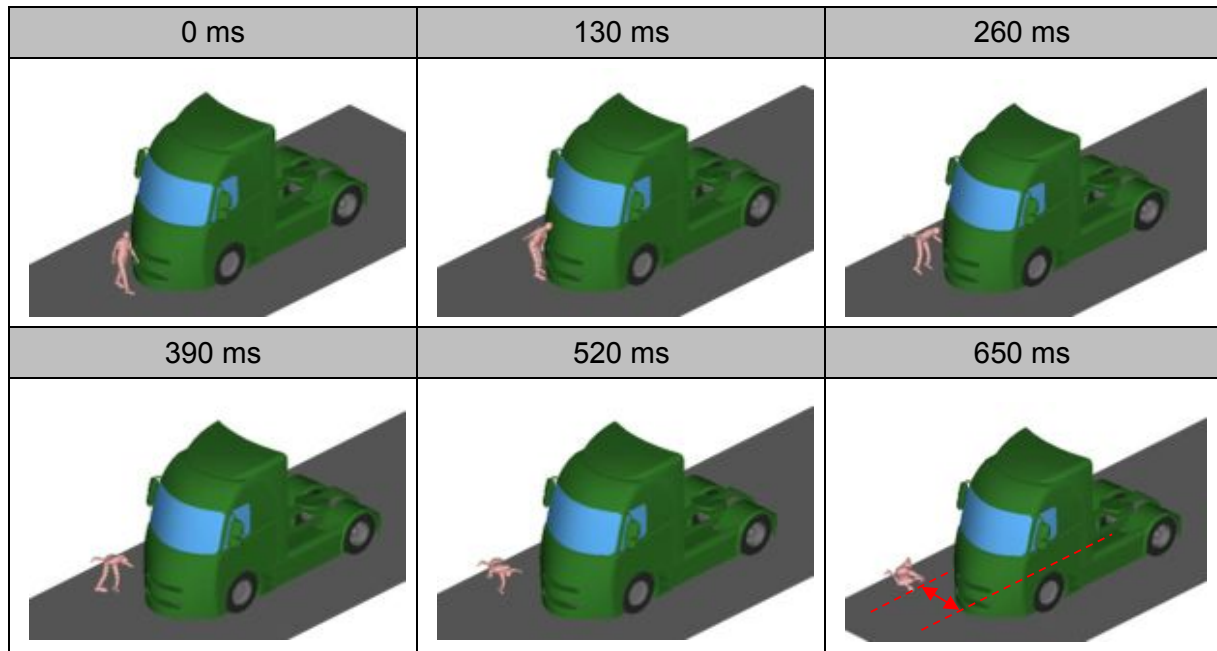


Fig. 6-75: Optimised concept against 50 % male

The results of all simulations are summarised in Fig. 6-76. The overrun is prevented in 100 % of the simulated cases for the advanced concept. In contrast simulations with the reference tractor lead to an overrun in 70 % of all cases.

Position	Human model	Reference	Advanced concept
Centre	6 year old child	overrun	no overrun
	5 % female	overrun	no overrun
	50 % male	overrun	no overrun
	95 % male	overrun	no overrun
Edge	6 year old child	no overrun	no overrun
	5 % female	no overrun	no overrun
	50 % male	no overrun	no overrun
	95 % male	overrun	no overrun
Cyclist	50 % male	overrun	no overrun

Fig. 6-76: Evaluation of VRU protection simulations

To quantify the possible reduction of fatalities due to the implemented measured comprehensive evaluation of traffic accident statistics in further studies are required.

6.3.3.3 Comparison of Self Protection Performance

The result of the simulation is shown in Fig. 6-77. The comparison of the simulation results already shows that the self protection performance of the advanced concept is improved.

The advanced concept absorbs more crash energy in the front part of the cabin. This becomes more evident when the intrusions into the front of the truck and the front lateral beam are evaluated. These are shown in Fig. 6-78 and Fig. 6-79.

The evaluation of the intrusions into the tractor front reveals that both the maximum value and the average values are lower at the advanced concept's front. From this follows that the survival space for the driver is larger and also the evacuation behaviour to rescue the driver is improved. The curves of occurring forces in the side members during the crash are shown in Fig. 6-80 and Fig. 6-81.

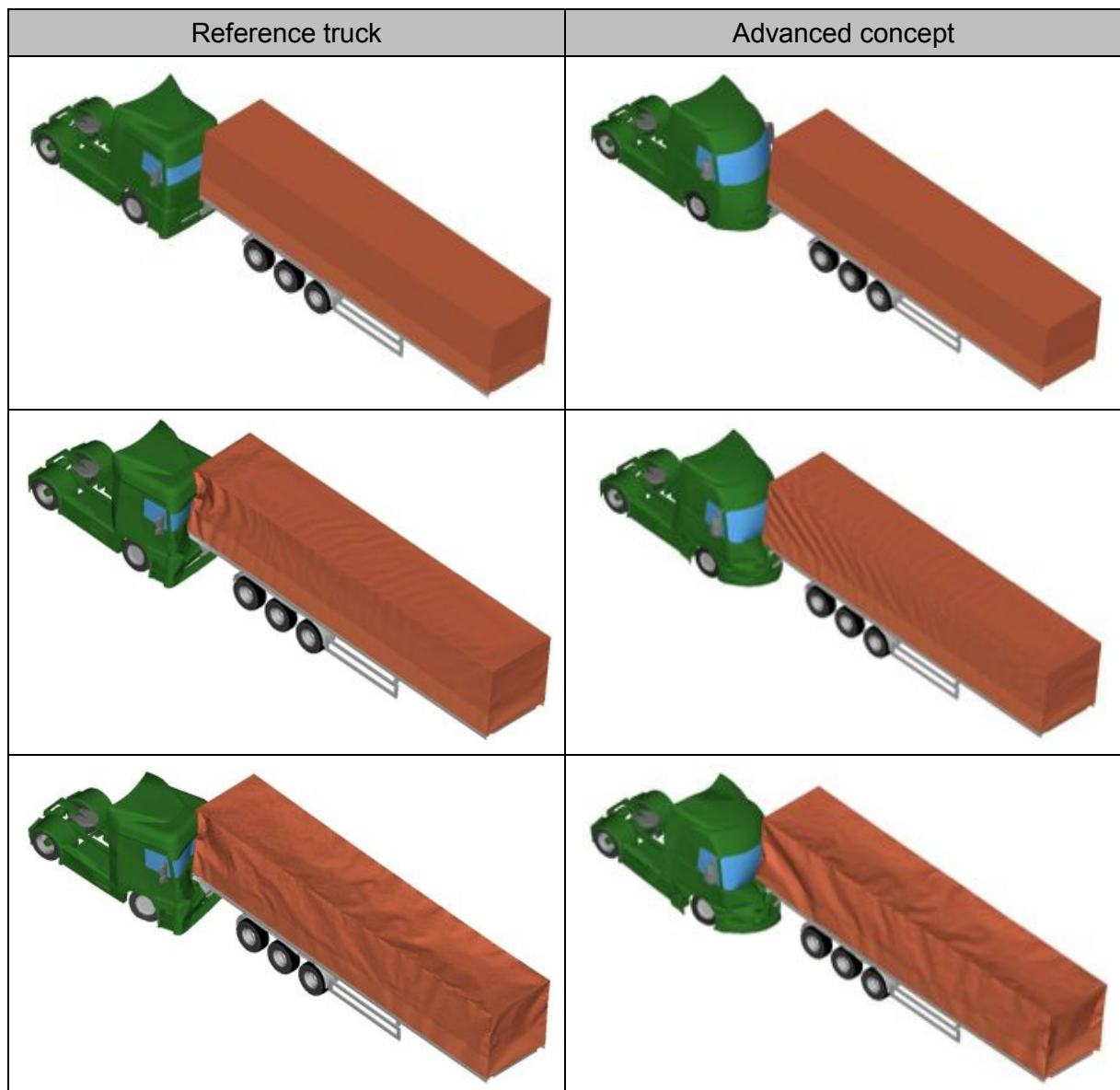


Fig. 6-77: Simulation results with additional crash management system

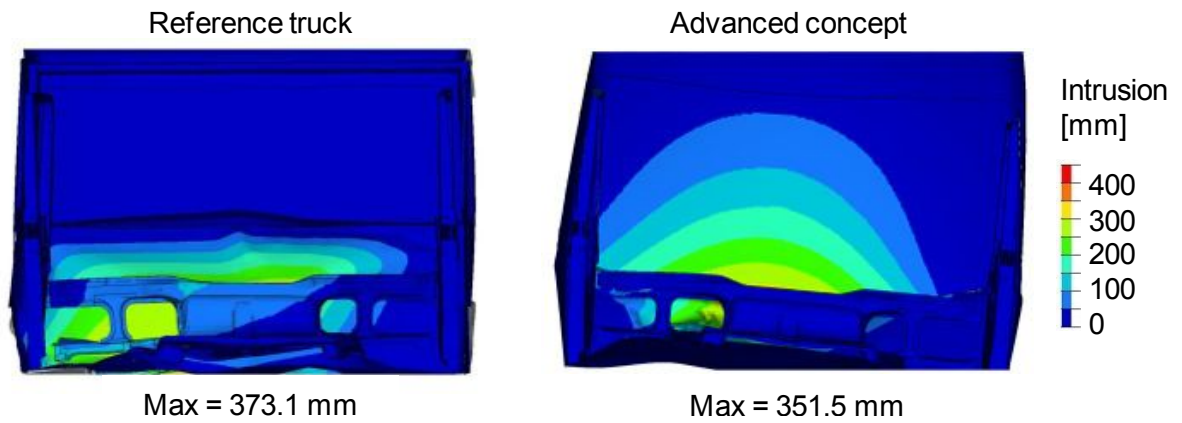


Fig. 6-78: Intrusion into front

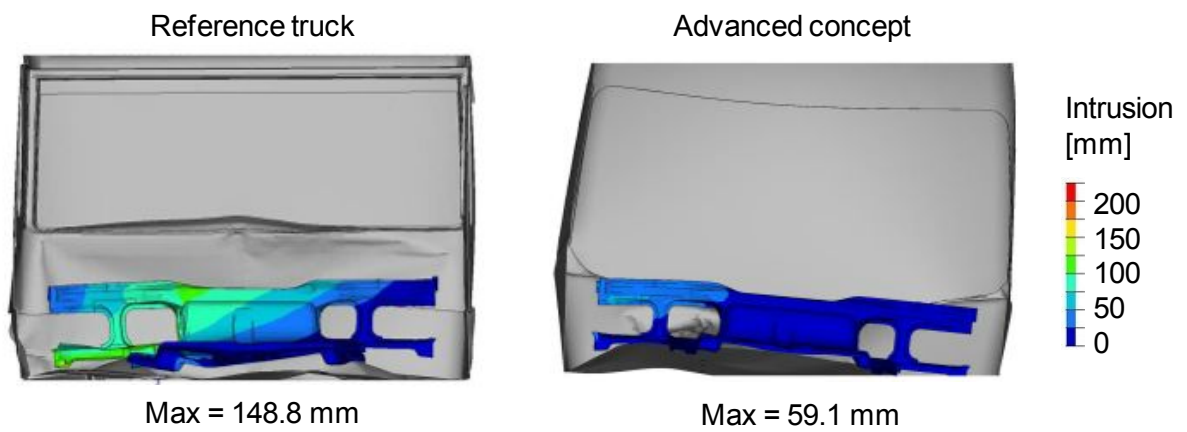


Fig. 6-79: Intrusion into the front lateral beam

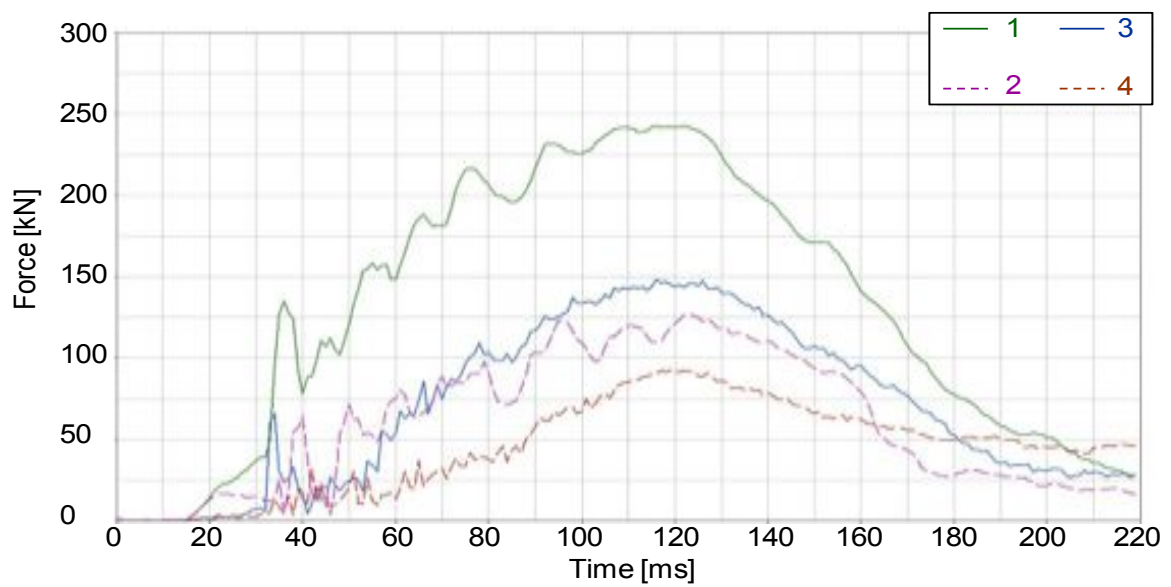


Fig. 6-80: Forces in the side members of the reference tractor during the crash

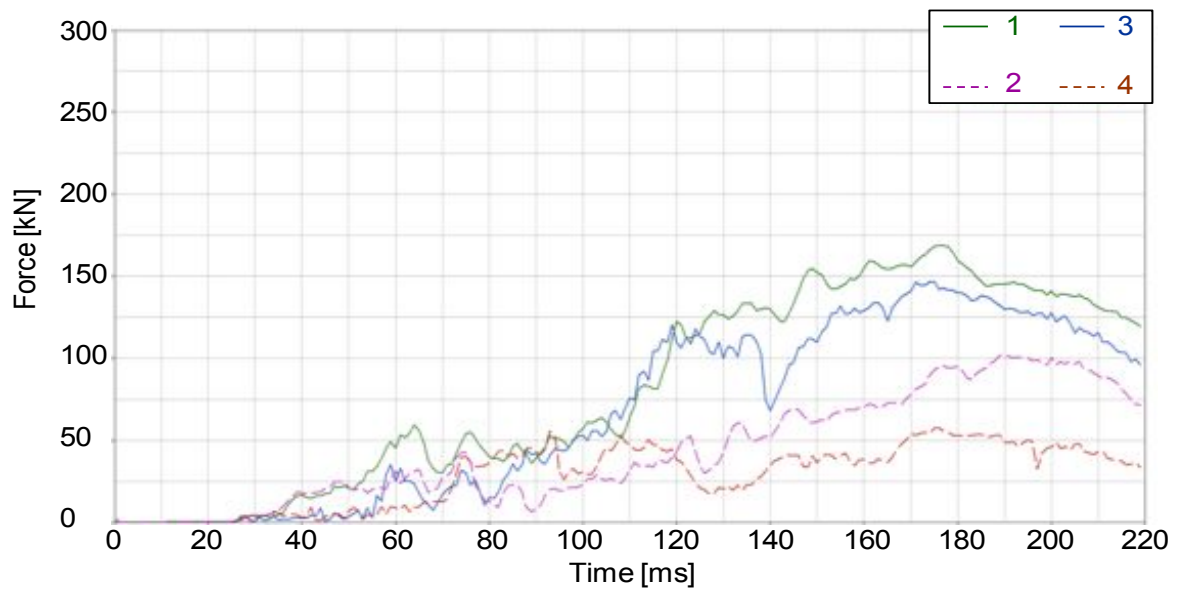


Fig. 6-81: Forces in the side members during the crash with crash management system

All curves show lower peak values, which leads to a reduction of the accident severity and also the evaluation of the occurring forces shows an improvement of the self protection performance.

The analysis of the simulation furthermore reveals that optimisation potential also exists in trailer design. It can be seen in Fig. 6-82 that the upper part of the crash management system hits the rear bumper of the trailer. The mounting of the rear bumper however collapses, so the crash management is not able to absorb lots of energy. Instead the side member of the trailer hits the cabin and causes high intrusions. This behaviour can be approved by alternative trailer concepts to mitigate accident consequences in this scenario.

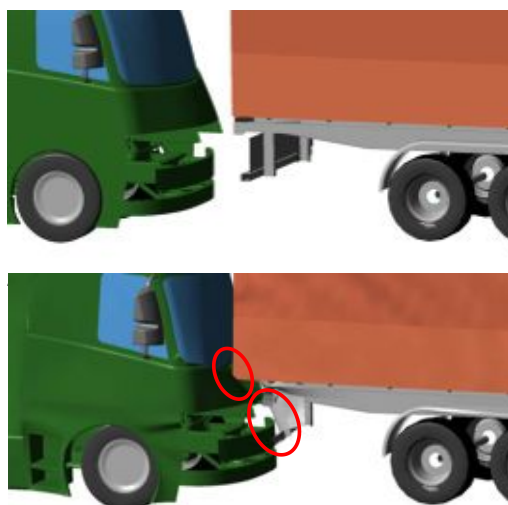


Fig. 6-82: Side view of crash kinematics

7 Technical Assessment

To evaluate the consequences of the optimisations on the vehicle, several criteria have to be analysed. The criteria are classified in the topics passive and active safety, lightweight design, structural requirements and others. An overview of the criteria is shown in Fig. 7-1.


<p>Passive safety:</p> <ul style="list-style-type: none"> • Good self protection performance • Good partner protection performance • Good pedestrian protection performance 		<p>Structural requirements:</p> <ul style="list-style-type: none"> • Easy reparability • Good corrosion resistance • Easy handling of towing device
<p>Active safety:</p> <ul style="list-style-type: none"> • Good visibility through screens • Good indirect vision • Good visibility by lighting installation • Easy application of driver assistance systems 		
<p>Lightweight design:</p> <ul style="list-style-type: none"> • Low weight • High weight saving by functional integration • Additional weight reduction strategies • Compliance of max. axle loads 		<p>Others:</p> <ul style="list-style-type: none"> • Good operability • High freedom of design (branding) • High degree of innovation • Effective engine cooling

Fig. 7-1: Evaluation criteria

In the next steps the criteria are ranked for importance on 40 t-HGVs. Therefore all criteria are compared with each other as described in Fig. 7-2. If both criteria have the same relevance, the rating is 1. If the criterion in the column is more important than the one in the line, the rating is set to 0. If the criterion in the line is the more important one, the rating is 2.

The sum of each criteria line results in a ranking shown in Fig. 7-3. The criteria with the highest points have a very high importance for the evaluation of the new structure. Overall five classes are used to evaluate the different criteria. As shown in Fig. 7-3 the compliance of the axle loads and safety requirements are the most important criteria for the technical evaluation of the new truck front shape. Some of the important criteria can be evaluated by the simulation results. Others are investigated in the following.

Pairwise comparison of the criteria		1	2	3	4	5	6	7	8	9	10	11	12	13	14	15	16	17	18
		Good self protection performance	Good partner protection performance	Good pedestrian protection performance	Easy reparability	Low weight	High weight saving by functional integration	Additional weight reduction strategies	Compliance of max. axle loads	Good operability	Good visibility through screens	Good indirect vision	Good corrosion resistance	High freedom of design (branding)	High degree of innovation	Easy application of driver assistance systems	Good visibility by lighting installation	Effective engine cooling	Easy handling of towing device
1	Good self protection performance		1	2	2	2	2	2	0	2	1	2	2	2	2	2	2	2	2
2	Good partner protection performance	1		1	2	2	2	2	0	2	1	2	2	2	2	2	2	2	2
3	Good pedestrian protection performance	0	1		2	2	2	2	0	2	1	2	2	2	2	2	2	2	2
4	Easy reparability	0	0	0		0	0	0	0	0	0	0	1	1	1	1	0	0	2
5	Low weight	0	0	0	2		1	1	0	1	0	0	2	2	1	1	0	1	2
6	High weight saving by functional integration	0	0	0	2	1		1	0	1	0	0	2	2	1	1	0	1	2
7	Additional weight reduction strategies	0	0	0	2	1	1		0	1	0	0	2	2	1	1	0	1	2
8	Compliance of max. axle loads	2	2	2	2	2	2	2		1	2	2	2	2	2	2	2	2	2
9	Good operability	0	0	0	2	1	1	1	1		1	1	2	2	2	1	1	1	2
10	Good visibility through screens	1	1	1	2	2	2	2	0	1		1	2	2	2	2	1	1	2
11	Good indirect vision	0	0	0	2	2	2	2	0	1	1		2	2	2	1	1	1	2
12	Good corrosion resistance	0	0	0	1	0	0	0	0	0	0	0		1	1	0	0	0	2
13	High freedom of design (branding)	0	0	0	1	0	0	0	0	0	0	0	1		1	0	0	0	1
14	High degree of innovation	0	0	0	1	1	1	1	0	0	0	0	1	1		1	0	0	2
15	Easy application of driver assistance systems	0	0	0	1	1	1	1	0	0	0	1	2	2	1		1	1	2
16	Good visibility by lighting installation	0	0	0	2	2	2	2	0	1	1	1	2	2	2	1		1	2
17	Effective engine cooling	0	0	0	2	1	1	1	0	1	1	1	2	2	2	1	1		2
18	Easy handling of towing device	0	0	0	0	0	0	0	0	0	0	0	0	1	0	0	0	0	

Fig. 7-2: Pairwise comparison of the criteria

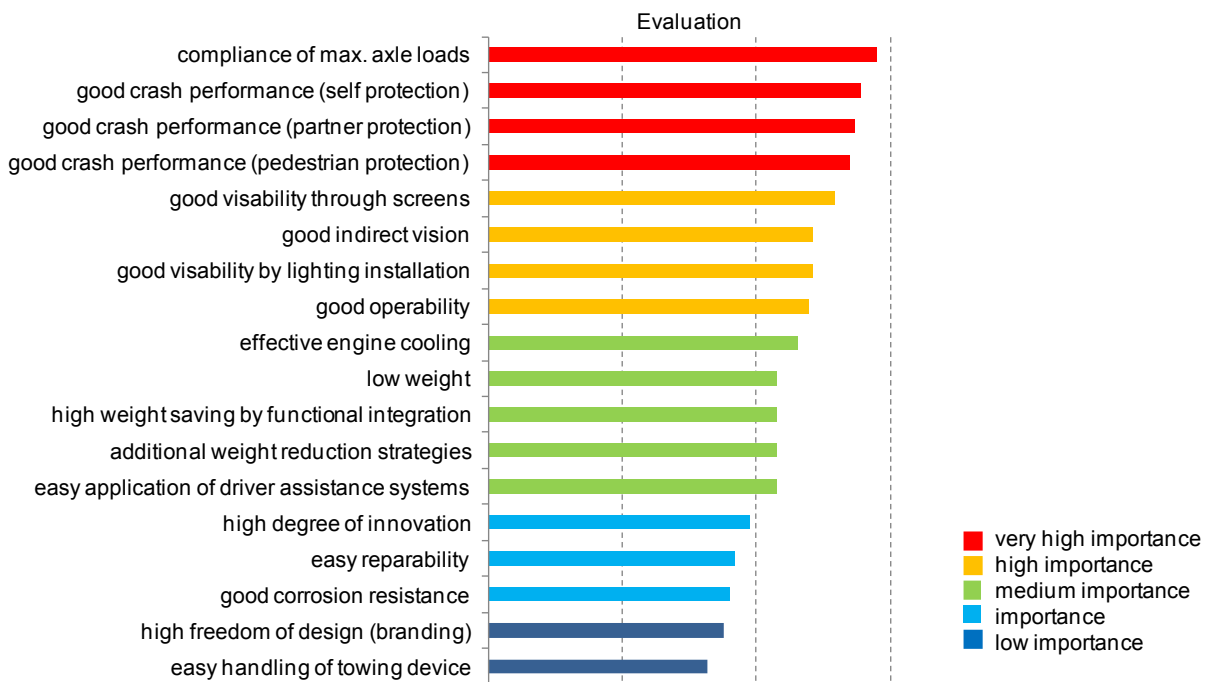


Fig. 7-3: Ranking of the criteria

To ensure sufficient lighting installation a possible set up for the reference tractor and the optimised tractor is shown in Fig. 7-5. The optimised concept does not require any special changes in lighting installation and functional areas for lighting installation are arranged. For that reason there are no disadvantages to expect compared to the reference truck. All requirements can be completely fulfilled.

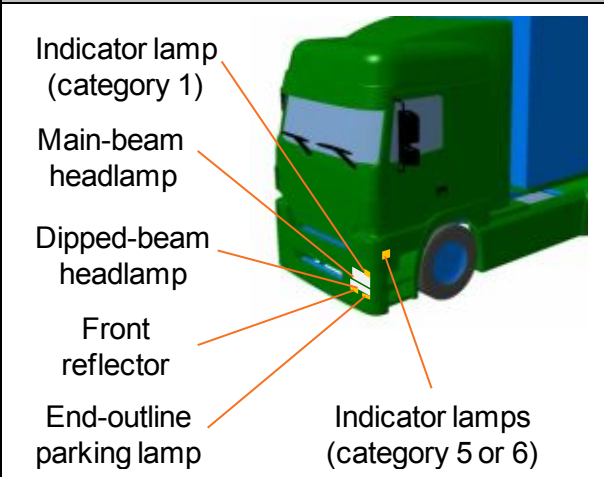
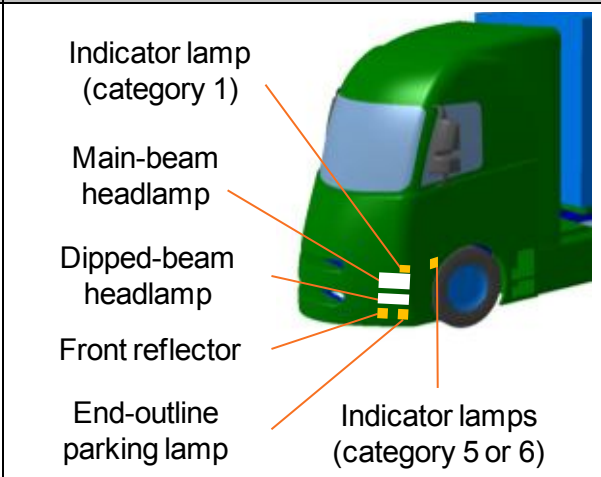
Reference tractor	Advanced concept
	

Fig. 7-4: Possible lighting installation

A lateral view of the reference truck and the optimised concept with the downward vision lines is shown in Fig. 7-5. Since there are no changes in positioning of the driver's seat, the eye points also remain in the same position. The lower edge of the optimised concept's windscreen is located further towards the front than reference truck's windscreen edge. To provide the same downward vision angle the windscreen edge of the optimised concept is lowered. Because of the extended front shape, the occultation area of the optimised concept is smaller than the area of the reference truck.



Fig. 7-5: Direct visibility trough front screen

The lateral area of downward vision occultation is considered in Fig. 7-6. To improve the direct vision in this direction the bottom side screen edges of the optimised concept are lower than at the reference tractor. The figure shows that this leads to a smaller occultation area.

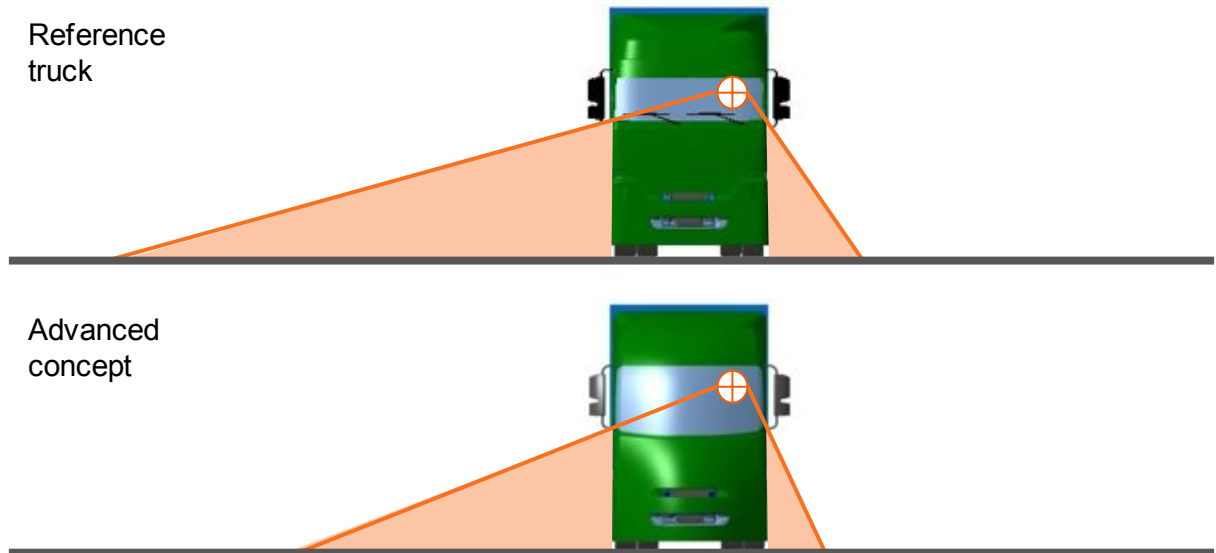


Fig. 7-6: Direct visibility trough side screens

The vision occultation in a top view can be seen in Fig. 7-7. The fields of occultation of the two concepts are similar, because there are no variations of the seat position and also the A-pillar position and rear side screen edges are similar. Furthermore even the reward indirect vision performance is not modified, because the main mirrors setup is the same in both concepts.

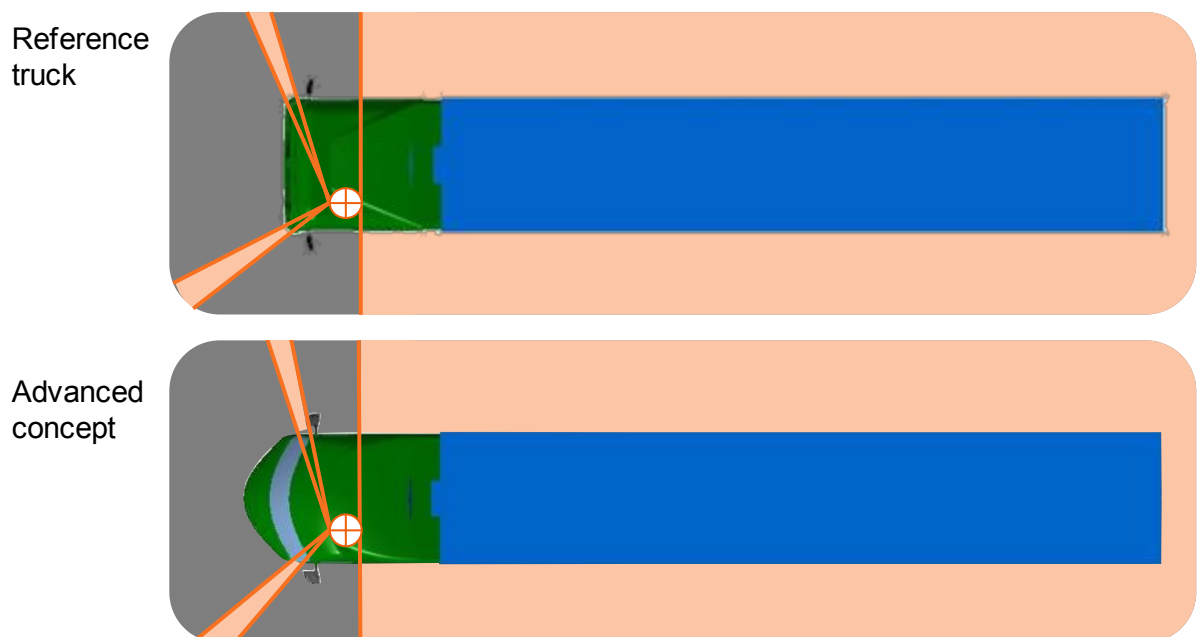


Fig. 7-7: Vision occultation in top view

Furthermore, it is apparent that the advanced concept offers more design space. To fulfil future emission regulations, larger components, for example, for engine cooling and exhaust after-treatment will be required. In this regard the advanced concept has advantages compared to the reference truck as well.

7.1 Estimation of the Impact on Fatality Numbers in Europe

The investigation of HGV accident statistics leads to an estimated number of 2121 to 2298 fatally injured car occupants in truck to car accidents per year. Due to improved partner protection performance that is proven in the simulation results, it can be expected that the accident severity will be mitigated for this amount of car occupants. However, a big share of these 2121 to 2298 fatalities is not avoidable, because they are attributable to high impact velocities. A distribution of the impact velocities for the different accident scenarios is currently not available in accident statistics.

Concerning fatal VRU accident with HGV involvement the total amount is estimated to 467 to 544. One reason for fatal injuries can be an overrun by the truck. The simulation results show that an overrun can be prevented in all of the simulated cases. However, another important factor that has an influence on the accident consequences is the initial contact between the VRU and the truck front. The front must be soft enough, so the accident opponent can survive this contact. Further detailed development of the advanced concept should aim to meet the requirements for the initial contact between the truck front and VRUs.

For an estimation of a number of avoided VRU fatalities, the distribution of HGV impact velocities in accidents with VRUs is required. It is illustrated in Fig. 7-8. In 40 to 50 % of all fatal VRU accidents the truck velocity is below 40 km/h [WAN05, SIM05]. For the following it is accepted that it is very unlikely to survive an accident with an impact speed higher than 50 km/h, so nearly 100 % of the fatal accidents happen with impact velocities less than this. For impact velocities below 40 km/h it can be expected that a high percentage of fatalities can be avoided, if the front structure is soft enough to survive the initial contact and an overrun does not happen. However, not all fatalities will be prevented, because the secondary contact between VRU and other objects like road users or any other obstacles in the nearer surroundings cannot be avoided. This secondary contact can also be responsible for fatal injuries. Hence it is assumed that 70 % of the fatalities in the lower velocities level can be prevented. That way an optimistic estimation is calculated in Eq. 7-1 and the pessimistic one in Eq. 7-2.

$$467 \cdot 40\% \cdot 70\% \approx 131 \quad \text{Eq. 7-1}$$

$$544 \cdot 50\% \cdot 70\% \approx 190 \quad \text{Eq. 7-2}$$

In the velocity level between 40 km/h and 50 km/h the percentage of avoided fatalities are expected to be low due to the high impact speed. The estimation that 30 % of these fatalities are preventable leads to a number of 232 to 296 avoided fatalities according to Eq. 7-3 and Eq. 7-4.

$$131 + (467 - 131) \cdot 30\% \approx 232 \quad \text{Eq. 7-3}$$

$$190 + (544 - 190) \cdot 30\% \approx 296 \quad \text{Eq. 7-4}$$

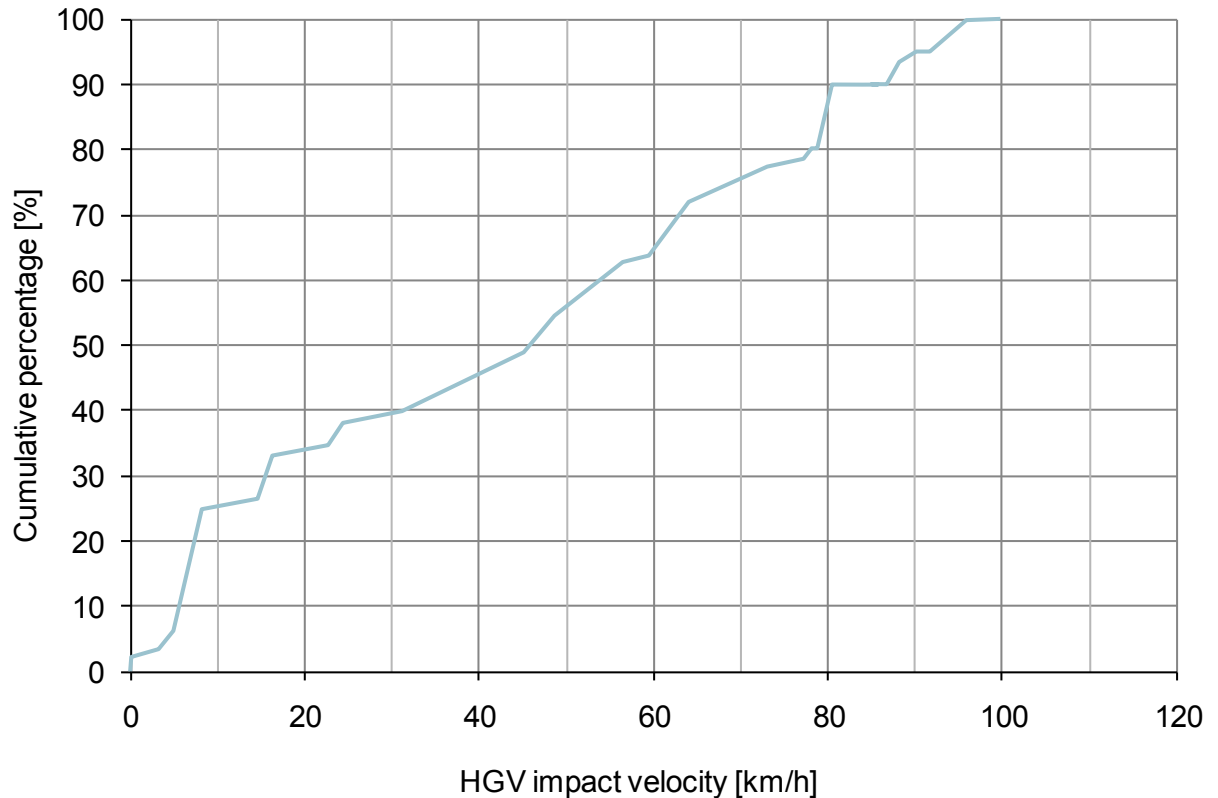


Fig. 7-8: Distribution of HGV impact velocities in accidents with VRUs [SMI05]

Additionally, the improvement of the field of direct view can have a positive effect on the number of killed VRUs. Because of the smaller occultation area of the advanced concept, the probability that VRU are recognised in critical situations is greater, so accidents can be prevented. Fig. 7-9 and Fig. 7-10 clarify this.

The improved downward vision can mainly improve impact on the scenarios 1, 4 and 5 from Fig. 6-47. It is difficult to estimate the amount of lives saved, but the fact that in 47 % among the accidents occurring on an intersection and involving at least one VRU blind spots from the truck driver's view are the main cause of the accident [IRU06], makes clear that positive effects can be achieved.

The simulation results reveal that also for the truck occupants a mitigation of the accident consequences is expected. But in this context it is important to mention that this group exhibits a share of 50 % to 75 % of drivers who refuse to use a seat belt [DEK09]. It is necessary to increase this percentage. The positive effect of the developed front shape of the advanced concept can be utilised for drivers who are restrained properly.

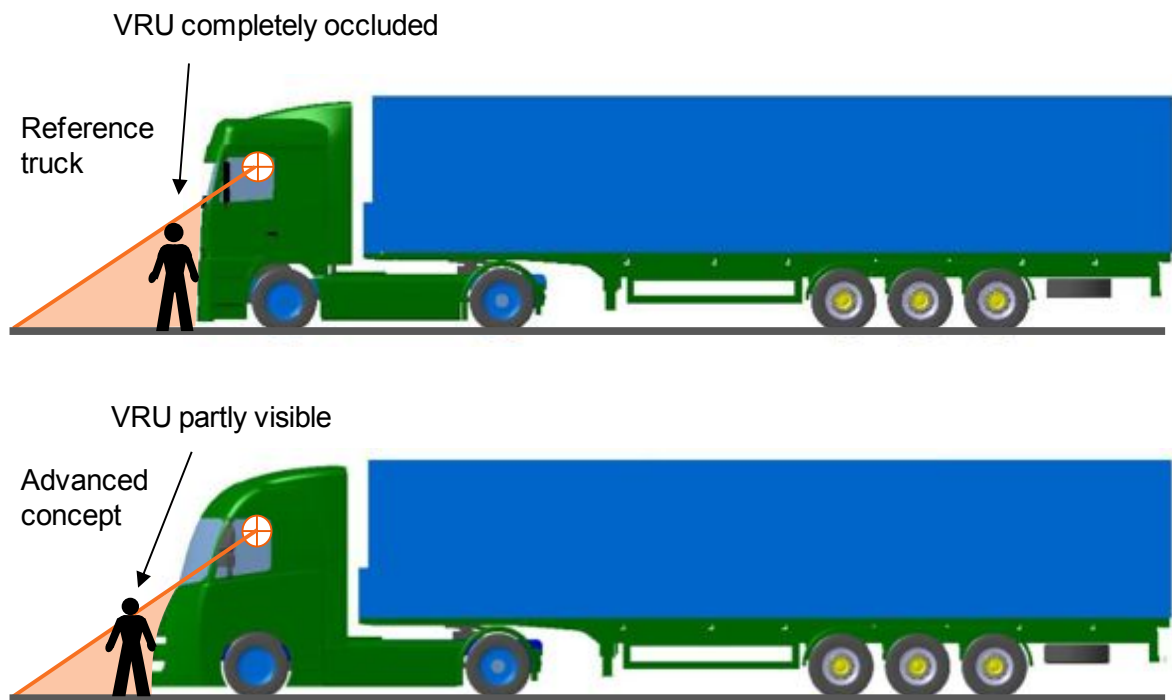


Fig. 7-9: Occlusion of VRUs in side view

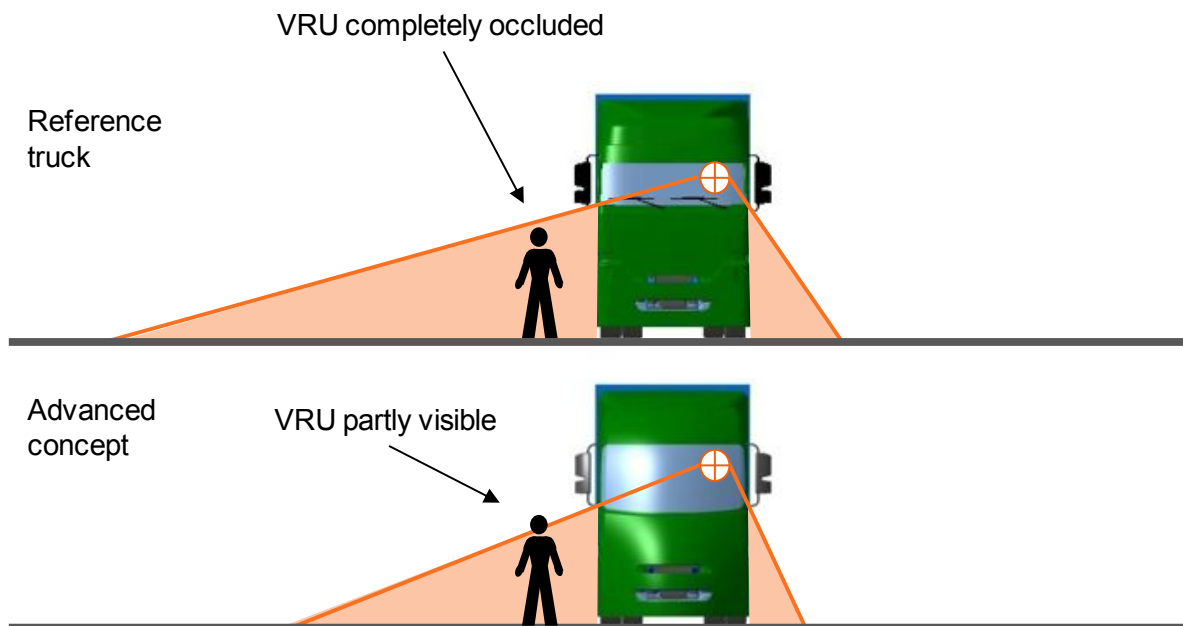


Fig. 7-10: Occlusion of VRUs in front view

7.2 Weight Investigation

For a first estimation of the weight difference, the general structure and also the used materials and manufacturing technologies for the advanced concept shall remain the same as for the reference tractor. The weight changes as a result from changing the size and the

density of the respective parts. The weight increase because of the enlargement of the windscreen as illustrated in Fig. 7-11. The investigation of the front covers and glazing are explained in Fig. 7-11 and Fig. 7-12.


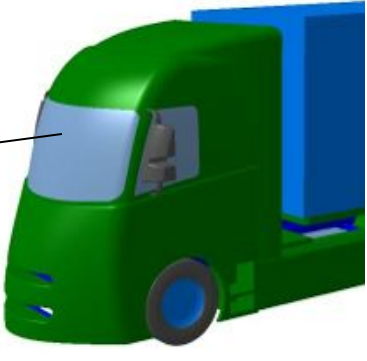
Reference tractor	Advanced concept
 <p>Front glazing area: 2.0 m² thickness: 5.5 mm</p>	 <p>Front glazing area: 3.0 m² thickness: 5.5 mm</p>
Weight increase: 12.3 kg	

Fig. 7-11: Weight increase because of larger windscreen


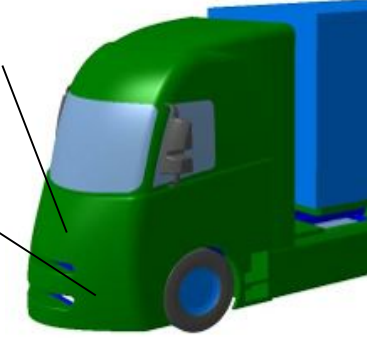
Reference tractor	Advanced concept
 <p>Cooling cover PP GF 30 area: 2.25 m² thickness: 5.5 mm</p> <p>Front bumper cover PP GF 30 area: 2.73 m² thickness: 6.0 mm</p>	 <p>Cooling cover PP GF 30 area: 2.25 m² thickness: 5.5 mm</p> <p>Front bumper cover PP GF 30 area: 1.83 m² thickness: 6.0 mm</p>
Weight reduction: 6.01 kg	

Fig. 7-12: Weight reduction because of smaller front cover

The crash management system's weight is 60.7 kg. The standard steel bumper system's weight is 53.6 kg. Since the crash management system replaces the steel bumper system, a further weight increase of 7.1 kg is caused by the advanced concept. All in all, the mentioned measures result in a total weight increase of 13.39 kg. To compensate this added weight lightweight design measures are considered. Fig. 7-13 shows the qualitative cost of lightweight design. It reveals that the usage of carbon fibre reinforced plastic (CFRP) enables high weight savings, but high expenses are incurred due to this. In contrast, aluminium

applications lead to a lower increase of production cost, but also the achievable weight reduction is lower.

The compensation of the added 13.39 kg of the changed tractor front can be realised by easy measures. For this reason the most cost efficient measures are considered. This means that aluminium parts which are easily applicable to the tractor by exchanging parts without any changes of the basal construction are investigated.

One example for such a measure is the usage of an aluminium fifth-wheel plate instead of a conventional steel device. This way a mass reduction between 33 kg (37 %) to 45 kg is possible. If the slider combination beneath it is also modified and adapted a reduction of even 58 kg is achievable.

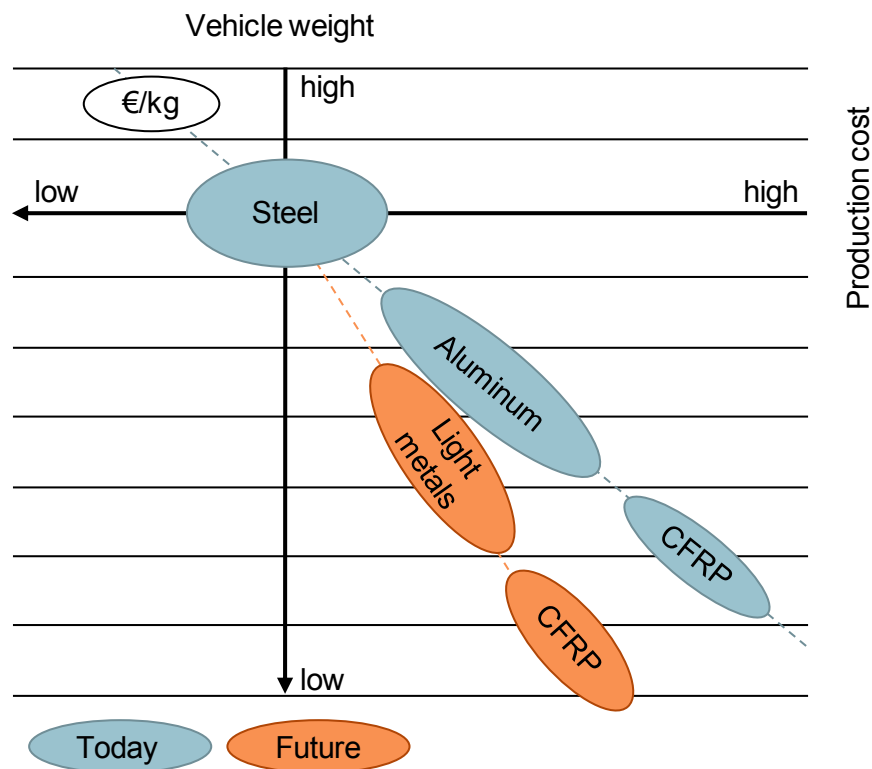


Fig. 7-13: Cost of lightweight design [GOE09]



Fig. 7-14: Aluminium fifth-wheel plate

Furthermore, aluminium wheels are an option to reduce weight. For a tractor with six wheels a total weight reduction of 120 kg can be realised, but the high cost of about 3000 € avoid a

higher market penetration. Furthermore aluminium wheels are more damageable as steel wheels when assembling the tyre.



Fig. 7-15: Aluminium wheel

7.3 Evaluation

After considering these points and the simulation results, the concept evaluation can be executed as shown in Fig. 7-16. To plot the result each evaluation value is multiplied by the according criterion ranking. After this all multiplied values are summed up. In total the reference truck reaches 306 evaluation points whereas the optimised concept reaches 426 points. The percentage result is shown in Fig. 7-17.

Fulfillment of the evaluation criteria			Reference truck	Advanced concept
Fulfillment of the criteria: 0,1,3,9 0: criteria not fulfilled 1: criteria less fulfilled 3: criteria partially fulfilled 9: criteria completely fulfilled				
No.	Evaluation criteria	Rating	1	2
1	Good self protection performance	5	3	9
2	Good partner protection performance	5	3	9
3	Compliance of max. axle loads	5	9	9
4	Good pedestrian protection performance	5	1	9
5	Good visibility through screens	4	1	3
6	Good indirect vision	4	9	9
7	Good visibility by lighting installation	4	9	9
8	Low weight	3	9	9
9	High weight saving by functional integration	3	3	3
10	Additional weight reduction strategies	3	3	3
11	Good operability	3	9	3
12	Easy application of driver assistance systems	3	9	9
13	Effective engine cooling	3	9	9
14	Easy reparability	2	3	3
15	Good corrosion resistance	2	3	9
16	High degree of innovation	2	0	9
17	High freedom of design (branding)	1	3	9
18	Easy handling of towing device	1	9	3

Fig. 7-16: Technical concept assessment

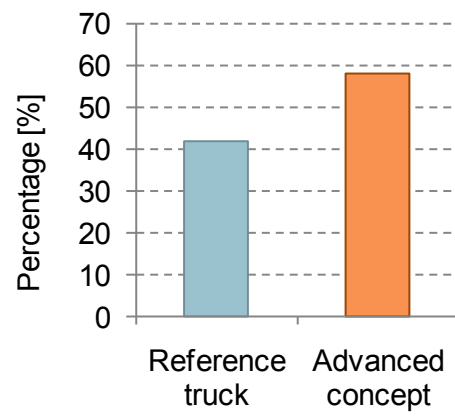


Fig. 7-17: Result of technical Assessment

8 Environmental and Economic Assessment

For the evaluation of the different criteria in the environmental and technical assessment, the same approach as in the technical assessment is used. The criteria are classified in the environmental aspects, economic aspects concerning production as well as economic aspects concerning the total cost of ownership. An overview of the criteria is shown in Fig. 8-1.


Economic aspects (production):		Economic aspects (total cost of ownership):
<ul style="list-style-type: none"> • High production numbers • Low variety of components • Low material cost • Low investment cost • Low manufacturing cost • Low joining cost • High modularisation • High degree of automation • Easy usage of available manufacturing facilities 		<ul style="list-style-type: none"> • Low tractor purchase price • Low fuel cost • Low cost for insurance • Low cost for taxes and toll
Others:		Environmental aspects:
<ul style="list-style-type: none"> • Comfortable interior concept (driving and resting) • Impression of exterior styling 		<ul style="list-style-type: none"> • Low fuel consumption by aerodynamic measures • Low fuel consumption by non-aerodynamic measures • Low emissions • Good recyclability • Reduction of injuries and fatalities in road traffic

Fig. 8-1: Evaluation criteria

Again the criteria are ranked for importance on 40 t-HGVs with the same rating as in the technical assessment (Fig. 8-2). The overall rating with a subdivision in five classes is shown in Fig. 8-3. The most important criterion on the environment is again a safety aspect with the reduction of injuries and fatalities in road traffic. This criterion is followed by the reduction of fuel consumption and emissions.

		1	2	3	4	5	6	7	8	9	10	11	12	13	14	15	16	17	18	19	20
		High production numbers	Low variety of components	Low material costs	Low investment costs	Low manufacturing costs	Low joining costs	High modularisation	High degree of automatisisation	Easy usage of available manufacturing facilities	Low tractor purchase price	Low fuel costs	Low costs for insurance	Low costs for taxes and toll	Low fuel consumption by aerodynamic measures	Low fuel consumption by non-aerodynamic measures	Low emissions	Good recyclability	Reduction of injuries and fatalities in road traffic	Comfortable interior concept	Impression of exterior styling
1	High production numbers		1	1	1	1	1	1	1	2	1	0	0	0	0	0	0	1	0	1	1
2	Low variety of components	1		1	1	1	1	1	1	1	0	0	0	0	0	0	0	1	0	1	1
3	Low material costs	1	1		1	1	1	1	1	1	1	0	0	0	0	0	0	1	0	1	1
4	Low investment costs	1	1	1		1	1	1	1	1	0	0	0	0	0	0	1	0	1	1	1
5	Low manufacturing costs	1	1	1	1		1	1	1	1	0	0	0	0	0	0	1	0	1	1	1
6	Low joining costs	1	1	1	1	1		1	1	1	0	0	0	0	0	0	1	0	1	1	1
7	High modularisation	1	1	1	1	1	1		1	2	1	0	0	0	0	0	1	0	1	1	1
8	High degree of automatisisation	1	1	1	1	1	1	1		1	0	0	0	0	0	0	1	0	1	1	1
9	Easy usage of available manufacturing facilities	0	1	1	1	1	1	0	1		1	1	1	1	1	1	1	1	0	1	1
10	Low tractor purchase price	1	2	1	1	1	1	2	1	1		1	1	1	0	0	2	0	2	1	1
11	Low fuel costs	2	2	2	2	2	2	2	2	1	1		2	2	1	1	1	2	0	2	1
12	Low costs for insurance	2	2	2	2	2	2	2	2	1	1	0		1	0	0	2	0	2	1	1
13	Low costs for taxes and toll	2	2	2	2	2	2	2	2	1	1	0	1		0	0	2	0	2	1	1
14	Low fuel consumption by aerodynamic measures	2	2	2	2	2	2	2	2	1	2	1	2	2		1	1	2	0	2	2
15	Low fuel consumption by non-aerodynamic measures	2	2	2	2	2	2	2	2	1	2	1	2	2	1		1	2	0	2	2
16	Low emissions	2	2	2	2	2	2	2	2	1	2	1	2	2	1	1		2	0	2	2
17	Good recyclability	1	1	1	1	1	1	1	1	1	0	0	0	0	0	0	0		0	0	0
18	Reduction of injuries and fatalities in road traffic	2	2	2	2	2	2	2	2	2	2	2	2	2	2	2	2	2		2	2
19	Comfortable interior concept	1	1	1	1	1	1	1	1	1	0	0	0	0	0	0	0	2	0		1
20	Impression of exterior styling	1	1	1	1	1	1	1	1	1	0	0	0	0	0	0	0	2	0	1	

Fig. 8-2: Pair wise comparison of the criteria

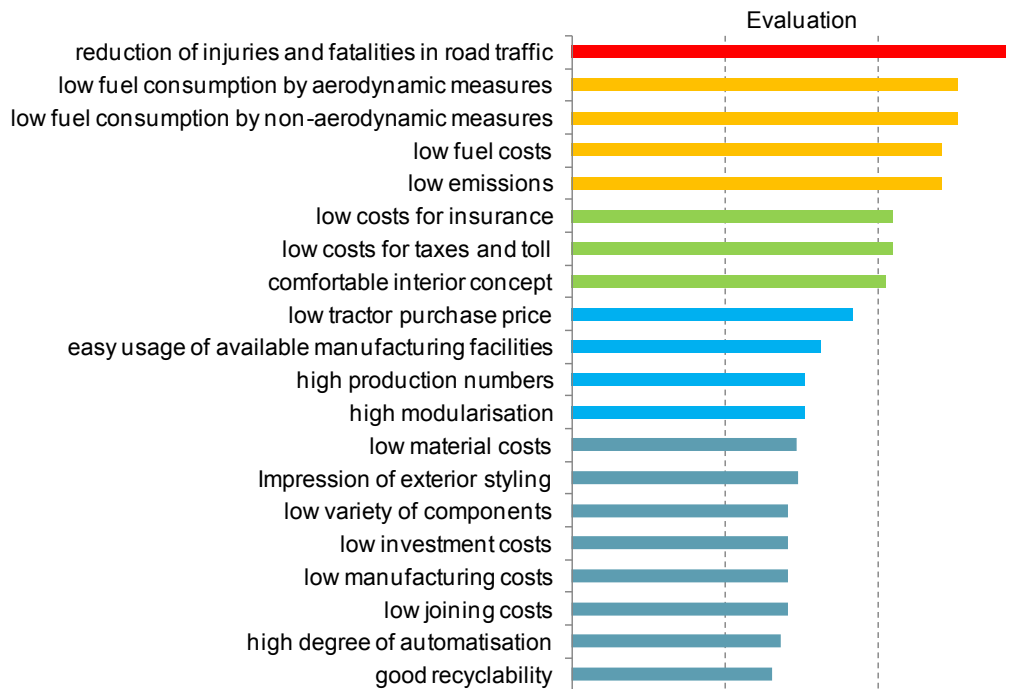


Fig. 8-3: Ranking of the criteria

Important criteria are investigated in the following. Others can be evaluated considering the simulation results.

One criterion to assess is the interior space of two concepts. The interior layout is an important factor, because truck drivers spend a lot of time inside the cabin. Hence it should be as comfortable as possible for driving and for resting as well. The cubage of the reference tractor cabin is 11.292 m^3 . The advanced concept provides $11,762 \text{ m}^3$ of interior space as shown in Fig. 8-4. Due to this the design possibilities are more extensive for the advanced concept.

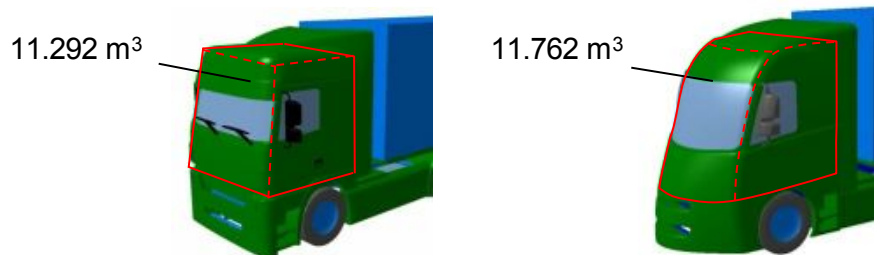


Fig. 8-4: Interior space of reference truck and advanced concept

An additional important point that needs to be considered for the introduction of the advanced concept is the impression of the exterior styling. The styling of new vehicle concepts shall not be too futuristic or seem strange to possible customers. For that reason photo realistic renderings of the advanced concept are prepared. Three examples can be seen in Fig. 8-5 and Fig. 8-6. Though the exterior styling cannot be assessed objectively the images show that the basic concept design does not disable an appealing exterior styling.



Fig. 8-5: Photo-realistic renderings



Fig. 8-6: Photo realistic rendering

8.1 Cost Estimation

A cost estimation is executed to evaluate the cost efficiency of the optimised concept. Therefore the total costs of ownership (TCO) are investigated. The distribution of the total cost of ownership can be seen in Fig. 8-7.

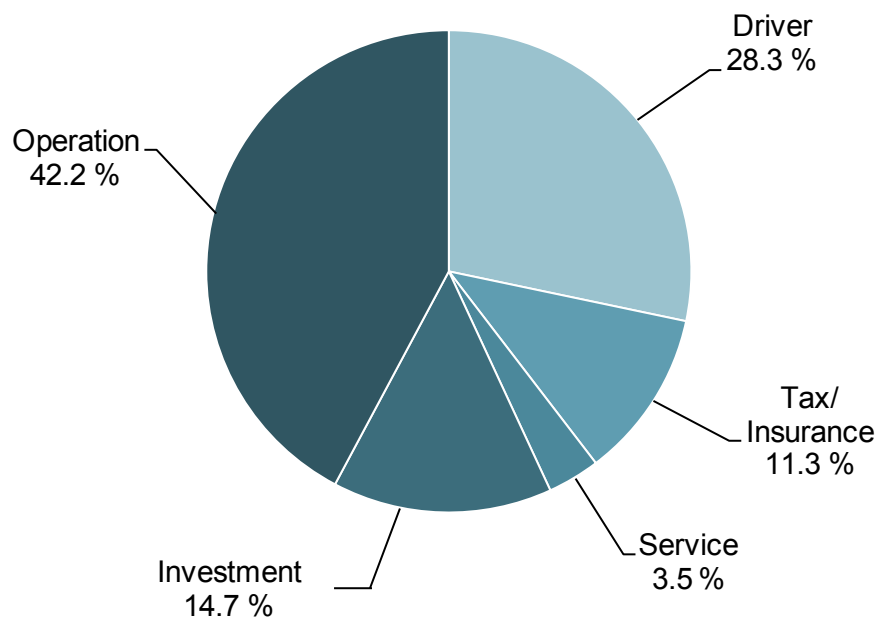


Fig. 8-7: Distribution of total cost of ownership (TCO) [TGX10]

For the estimation the following boundary conditions are accepted. The average service life of a haulage vehicle is 4 years. The annual mileage is valued at 125000 kilometres with an average fuel consumption of 31.1 l/100 km [HEL05].

To figure out the effect of the c_D value reduction on the fuel consumption simulations are executed. Therefore a Matlab/Simulink is build up. Fig. 8-8 shows the structure of the used model.

The drivetrain data are selected due to typical state of the art tractors. The internal combustion engine power is assumed at 320 kW at 1800 rpm. The transmission data are derived from typical 16 gear truck gearboxes. The c_D value for the simulation basis is calculated by CFD simulations of the reference truck to 0.703. Also the cross-sectional area of 10.42 m is calculated using the CFD model of the reference truck.

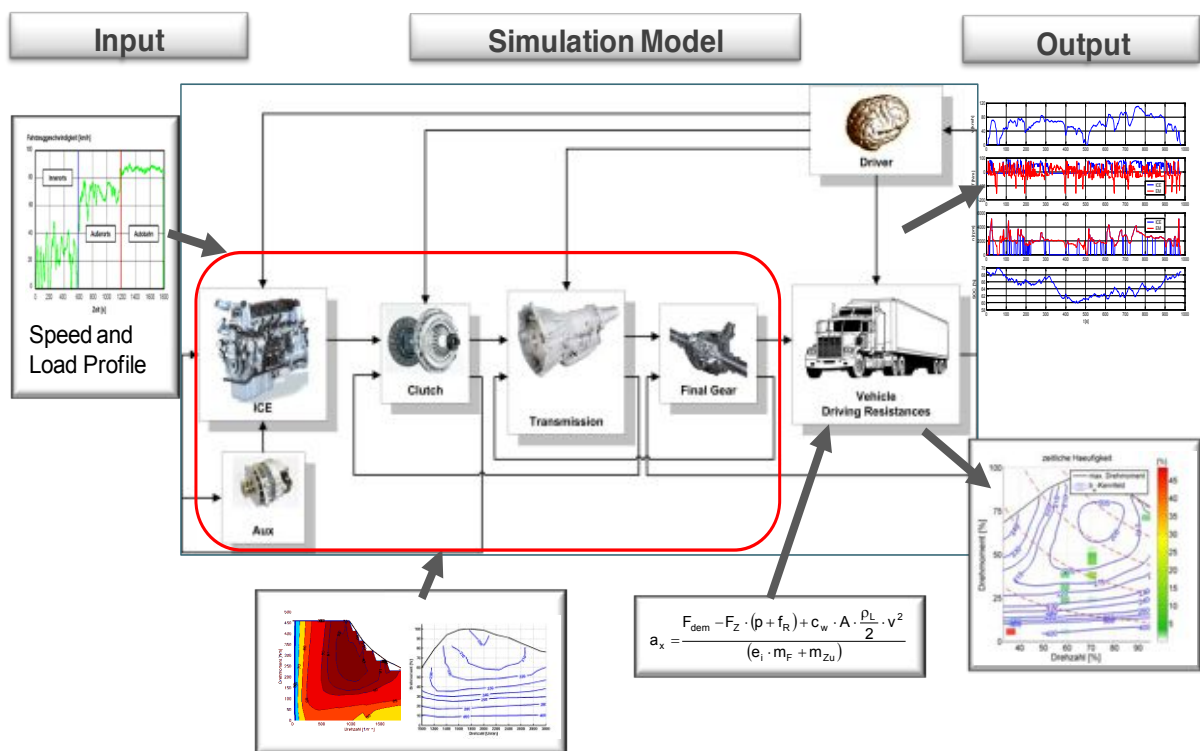


Fig. 8-8: Fuel consumption simulation model in Matlab/Simulink

The reference route used for the simulations is displayed in Fig. 8-9. This route leads from Aachen to Cologne and back. The associated velocity and altitude profiles can be seen in Fig. 8-10 and Fig. 8-11. The profiles are measured in test drives, so they represent realistic driving scenarios. Due to this it can be seen that there are also time periods, in which the truck is travelling with low speeds because of traffic volume for example.

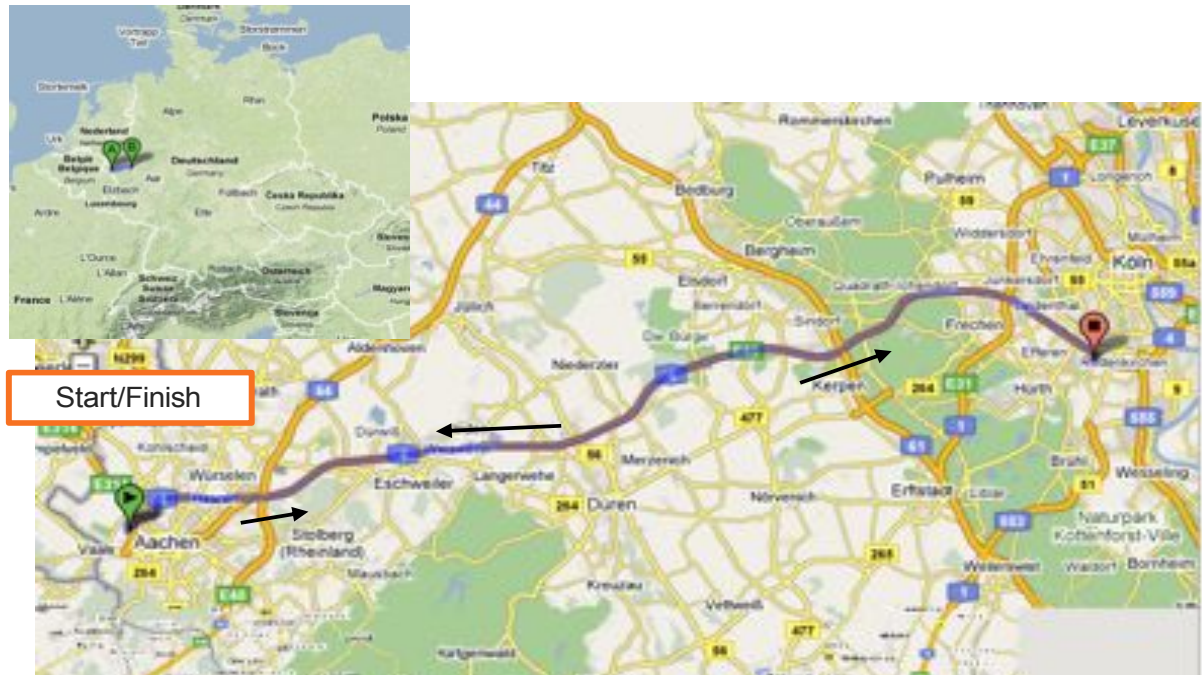


Fig. 8-9: Reference Route: Aachen - Cologne - Aachen

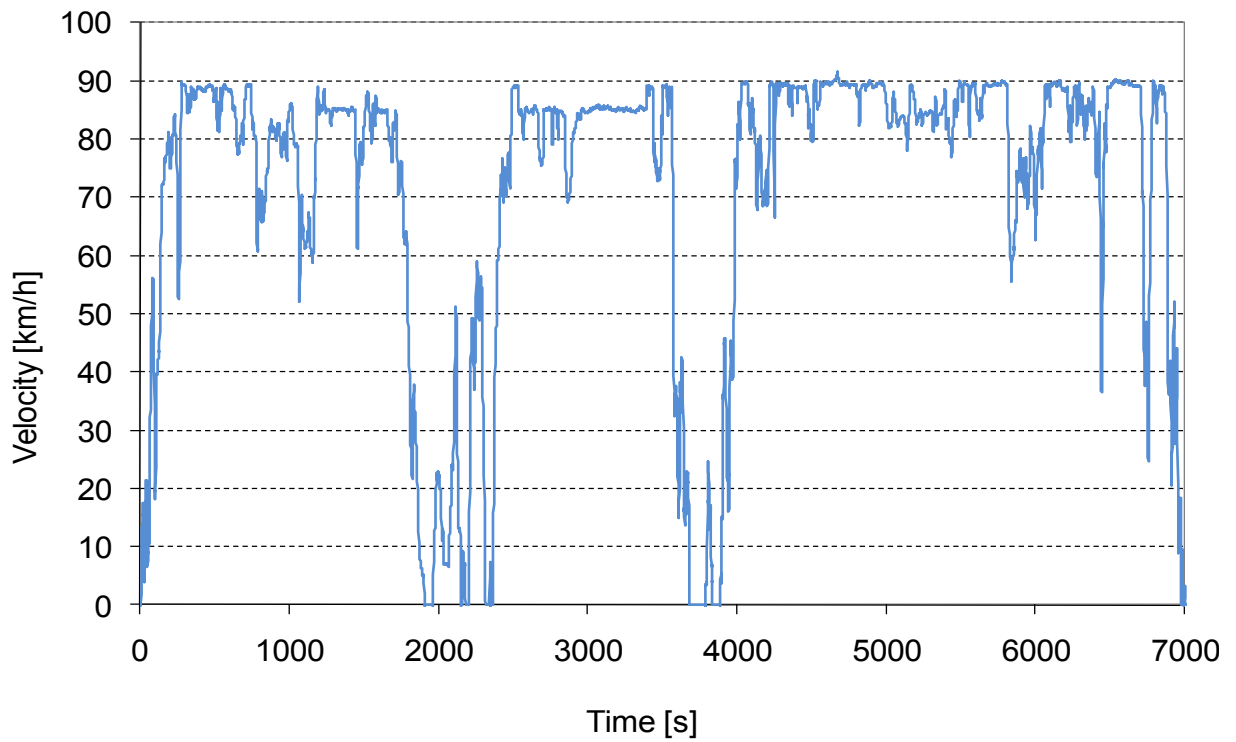


Fig. 8-10: Velocity Profile

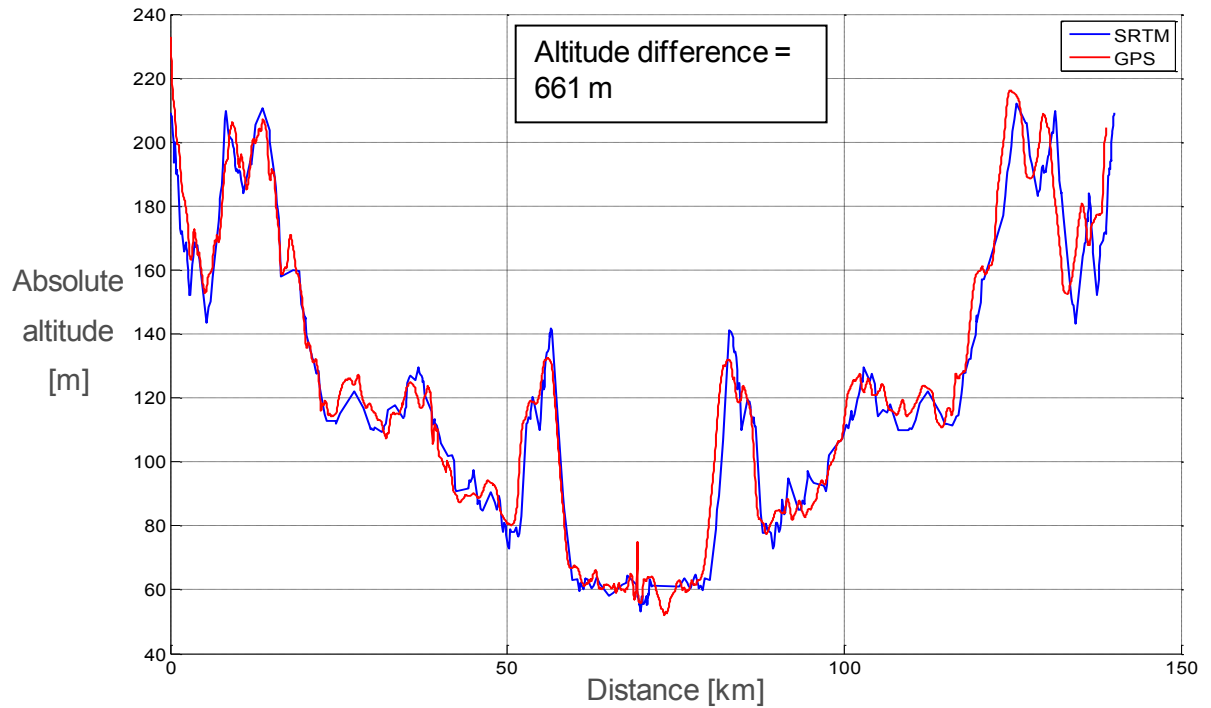


Fig. 8-11: Altitude Profile

Three different vehicle masses are considered in the simulations, one fully loaded vehicle with 40 t, one partly loaded with 25 t and an empty one with 17 t. Fig. 8-12 shows the results of the simulations. The relation between the change of c_D value and fuel consumption is linear.

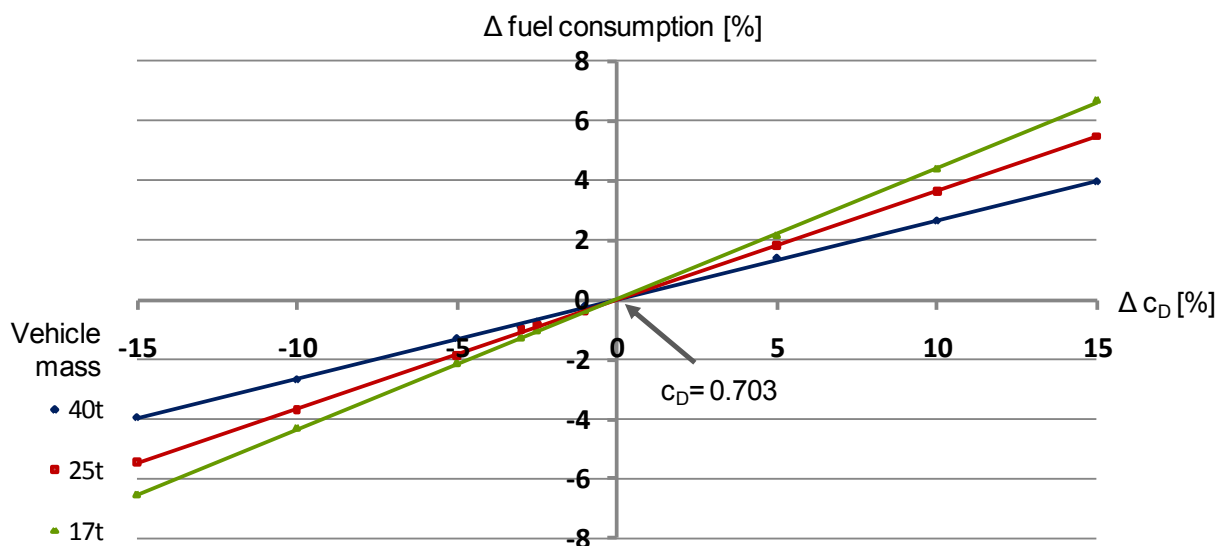


Fig. 8-12: Result of fuel consumption simulations

The optimised concept has a c_D value of 0.618, which is a reduction of 12.11 % compared to the reference basis. This leads to the reductions in fuel consumption that are listed in Fig. 8-13.

Vehicle mass	Reduction of fuel consumption
40 t	3.20 %
25 t	4.43 %
17 t	5.29 %

Fig. 8-13: Reduction of fuel consumption for different vehicle masses

For the calculation of the fuel savings and the according cost saving only a fully loaded vehicle is considered, because this reflects the minimum of savings that will be achieved in any case. If a vehicle is partly travelling with fewer loads, the savings will be accordingly higher than the calculated values. Fig. 8-14 shows the annual fuel savings for a vehicle with a mass of 40 t. The column representing the accepted annual kilometrage of 125,000 km is highlighted.

To translate the fuel savings into cost savings information about the fuel price are required. Fig. 8-15 shows diesel prices for several European countries. The average price is 1.16 € per litre. The development of the diesel prices shows a rising tendency. As an example the price development in Germany can be seen in Fig. 8-16. These numbers were collected in 35th calendar week of the year 2010.

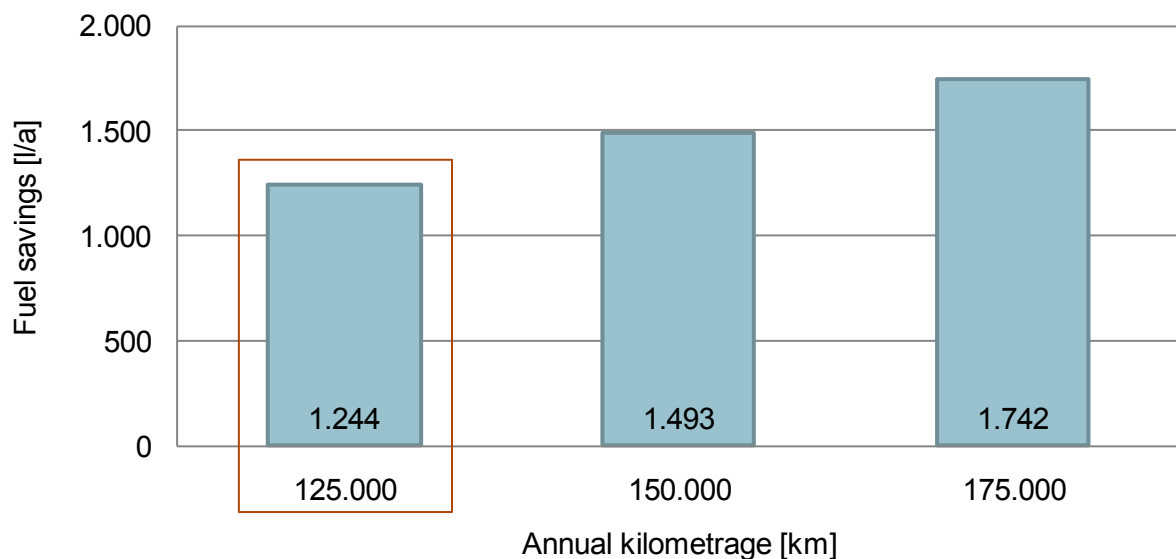


Fig. 8-14: Annual fuel savings

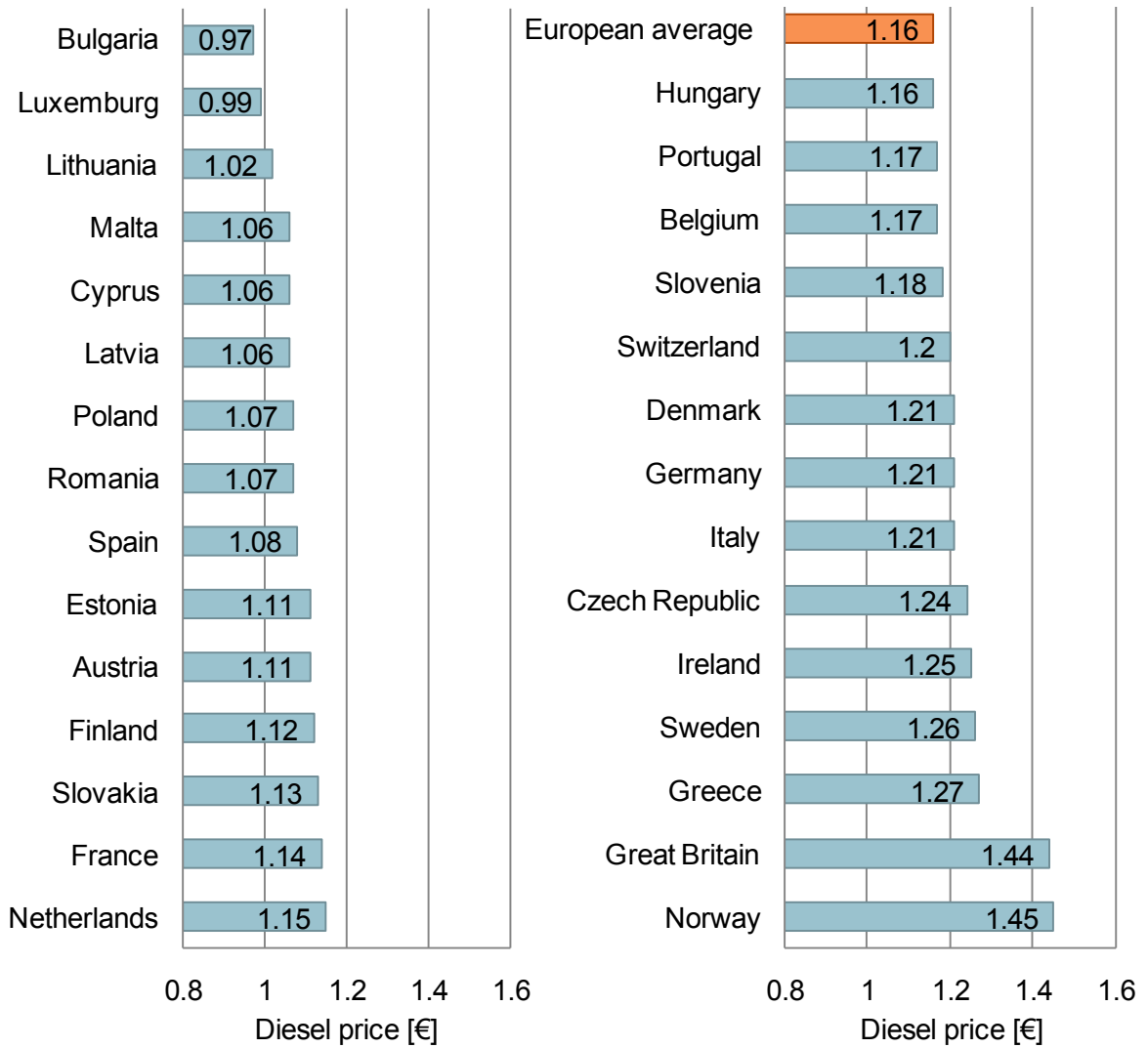


Fig. 8-15: Diesel prices in European countries [AVD10]

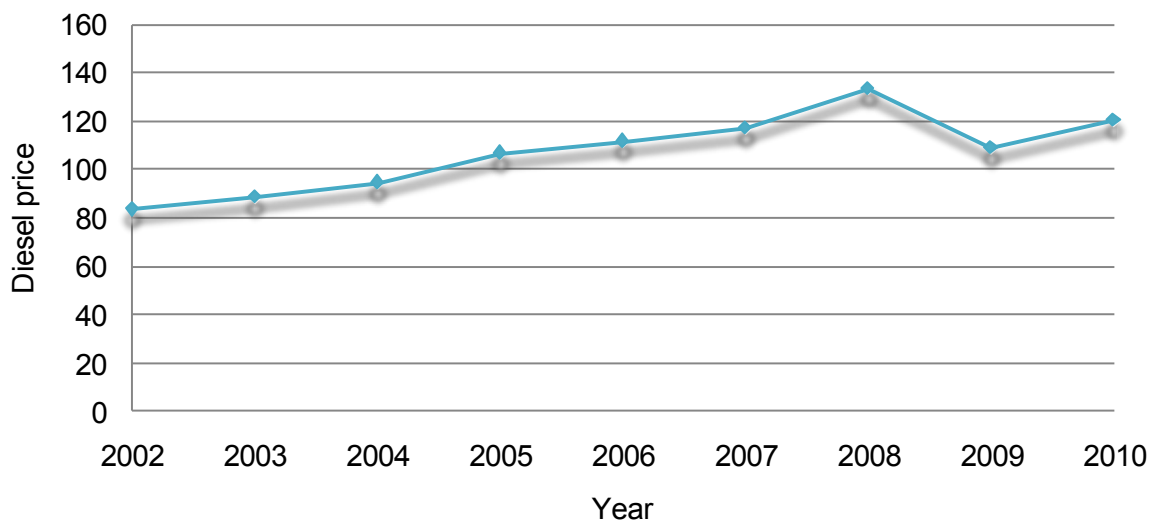


Fig. 8-16: Diesel price development in Germany [ARA10]

To achieve a realistic estimation for the near future a diesel price of 1.25 € (excluding VAT) is accepted. This price considers the European average and also the tendency. Inquiries of forwarding agencies show that in many cases contracts between the enterprises and the oil companies even reduce the price. The accordant cost savings are shown in Fig. 8-17, again for three different annual kilometrage scenarios.

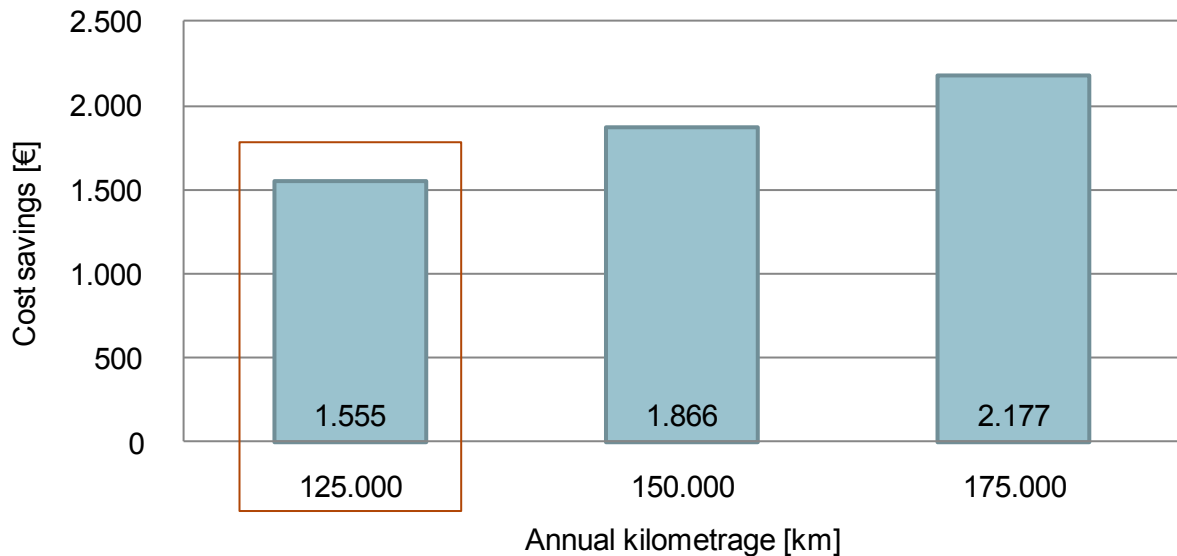


Fig. 8-17: Cost savings resulting from fuel savings

After the estimation of cost savings resulting from a fuel efficiency increase the changes of production cost are investigated. Analogous to the weight estimation the general structure and also the used materials and manufacturing technologies for the optimised concept shall remain the same as for the reference tractor in the first approach. The changes in cost result from changing the size of the respective parts. The area of the windscreen is calculated in subchapter 7.2. The additional size of the windscreen of the optimised concept causes a cost increase of 22.50 €. Similar investigations are also executed for the cooler cover and the front bumper cover. The cooler cover remains at the same size. The front bumper cover can be designed smaller than the one used for the reference tractor. It is assumed that the covers for both concepts are made from PP GF 30 plastics material, which is a standard material for such applications. Due to this there is a cost reduction of 12.02 €. Since an exact calculation of the CMS cost is not possible without detailed knowledge of many different parameters like production numbers, production process or integration of secondary parts, the cost estimation will be approximated by the weight of the part. Result of enquiries on that question is that the price of a part can be approximated by an average value of 5 to 6 Euros per kilo. The weight of the crash management system is 60.7 kg. That leads to an amount of 364.20 €. In total all these measures to extend the vehicle front lead to an increase of production cost of 398.72 €.

However, it should be noted that this approach would lead to a weight increase of 13.39 kg. But because this weight increase is relatively low in comparison with the overall weight of the tractor, the cost for weight reduction measures are neglected.

To estimate the feasible investment for research and development (R & D) for the manufacturers to achieve series-production readiness of the advanced concept, a depreciation period of four years is considered. The investigation of the running cost revealed that the advanced concept causes at least 1555 € of fuel saving. Considering a discounting of annual savings of 4 % the total cost savings sum up to 5870.27 € as shown by Eq. 8-1.

$$1555 \text{ €} + 1555 \text{ €} / 1.04 + 1555 \text{ €} / 1.04^2 + 1555 \text{ €} / 1.04^3 = 5870.27 \text{ €} \quad \text{Eq. 8-1}$$

After subtraction of the additional cost of 398.72 € the generated benefit is 5471.55 € per unit sold. This amount of money can be utilised for R & D. However no customer benefit would be generated this way. Manufacturers also often consider a depreciation period of two years. For this time period the feasible R & D cost can be calculated analogous to the previous calculation. For this case the generated benefit per unit is 2651.47 €.

The reduction of CO₂ emissions is illustrated in Fig. 8-18. This estimation is executed according to the fuel savings. As a basis for this calculation an emission of 2.65 kg CO₂ per combustion of 1 litre diesel is assumed.

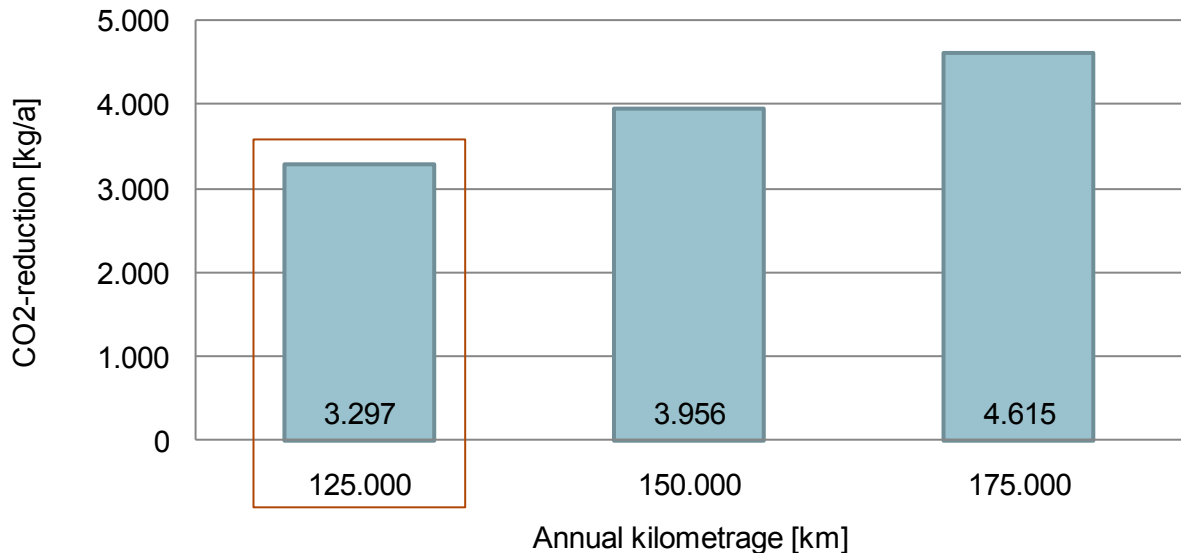


Fig. 8-18: CO₂-Reduction according to fuel savings

For an estimation of the reduction of CO₂ emissions across Europe kilometrage data for several European countries are aggregated in Fig. 8-19.

Country	Million kilometres per year	Country	Million kilometres per year
Austria	1476	Ireland	619
Belgium	1836	Italy	385
Bulgaria	763	Latvia	424
Cyprus	39	Lithuania	765
Czech Republic	2398	Luxemburg	496
Denmark	1175	Netherlands	5145
Estonia	292	Poland	8641
Finland	1113	Portugal	1813
France	12679	Romania	1060
Germany	17910	Slovakia	1351
Great Britain	7614	Slovenia	823
Greece	619	Spain	10462
Hungary	1757	Sweden	1445
Sum			86077

Fig. 8-19: Kilometrage of 40 t vehicles in Europe [EUR10]

For the estimation again an average fuel consumption of 31.1 l/100 km is assumed [HEL05]. The calculated reduction of fuel consumption of 3.20 % in the worst case leads to a total fuel saving of about 856 million litres per year and an according reduction of CO₂ emissions of approximately 2.3 million tons per year. In the best case a reduction of fuel consumption of 5.30 % could be possible. This would save 1.4 billion litres fuel per year and cause a reduction of CO₂ emissions of approximately 3.8 million tons. Compared to the overall emissions of 962 million t CO₂ caused by road traffic this means a reduction of 0.24 % (worst case) to 0.40 % (best case) [EUR10].

8.2 Evaluation

After considering simulation results and the previously described estimations the assessment is executed. The individual evaluations are summarised in Fig. 8-20. The assessment results can be seen in Fig. 8-21.

Fulfillment of the evaluation criteria			Reference truck	Advanced concept
No.	Evaluation criteria	Rating		
Fulfillment of the criteria: 0,1,3,9 0: criteria not fulfilled 1: criteria less fulfilled 3: criteria partially fulfilled 9: criteria completely fulfilled				
1	High production numbers	2	3	3
2	Low variety of components	1	3	3
3	Low material costs	1	9	3
4	Low investment costs	1	9	3
5	Low manufacturing costs	1	9	9
6	Low joining costs	1	9	9
7	High modularisation	2	3	3
8	High degree of automatisation	1	1	1
9	Easy usage of available manufacturing facilities	2	9	9
10	Low tractor purchase price	2	9	3
11	Low fuel costs	4	1	9
12	Low costs for insurance	3	3	9
13	Low costs for taxes and toll	3	9	9
14	Low fuel consumption by aerodynamic measures	4	1	9
15	Low fuel consumption by non-aerodynamic measures	4	1	3
16	Low emissions	4	1	3
17	Good recyclability	1	1	9
18	Reduction of injuries and fatalities in road traffic	5	1	3
19	Comfortable interior concept	1	3	9
20	Impression of exterior styling	1	3	9

Fig. 8-20: Environmental and economical concepts assessment

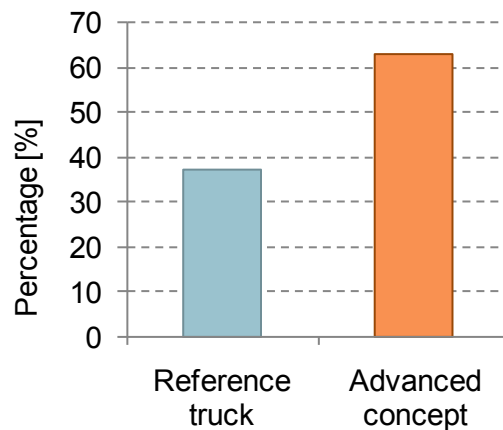


Fig. 8-21: Results of environmental and economical assessment

9 Recommendations

The results of this study show that significant reductions of fuel consumption and an improvement of road safety are achievable by changing the front of trucks. To achieve these targets changes in legislation regarding the maximum dimensions, material usage and direct field of view are required.

9.1 Design Space

To reduce the fuel consumption and increase the road safety of trucks a length extension of the front part of the tractor is necessary. Hence the limit for an overall length of 17.3 m is suggested in this study. An important point is that this extension should not be used to increase the cargo space, but to create a rounded aerodynamic front shape. Due to this, the length limitation for trailers should not be changed.

Furthermore the rounding of the front should be assured by the arranged design space of future regulations. For this purpose an examination geometry is defined. This geometry is described by two circles. The first one is located on the street plane. It has a radius of 1.48 m. The centre point is on the centre plane of the vehicle. The second circle is positioned on the centre plane. It has a radius of 6.45 m. The centre of this circle is located on the street plane. Both circles intersect at a reference point that is located 5 cm in front of the foremost point of the tractor on the street plane and on the centre plane of the vehicle. Fig. 9-1 explains the position of the two circles. The position of the reference point is shown in Fig. 9-2.

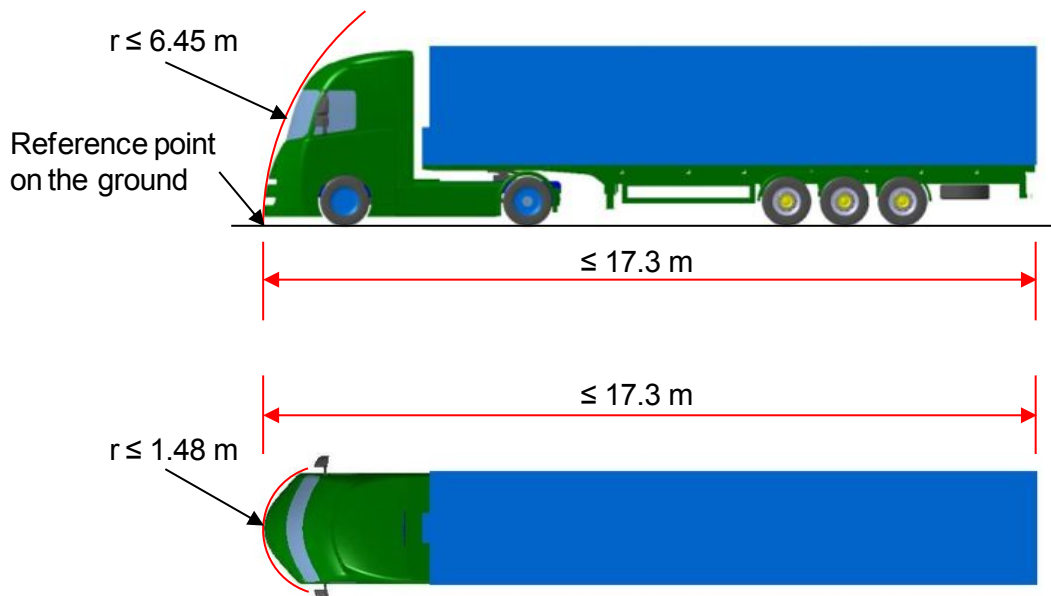


Fig. 9-1: Description of examination geometry

The two circles span a surface in front of the tractor. This surface shall not be pierced by any part of the tractor. The surface of the examination geometry can be seen in Fig. 9-3.

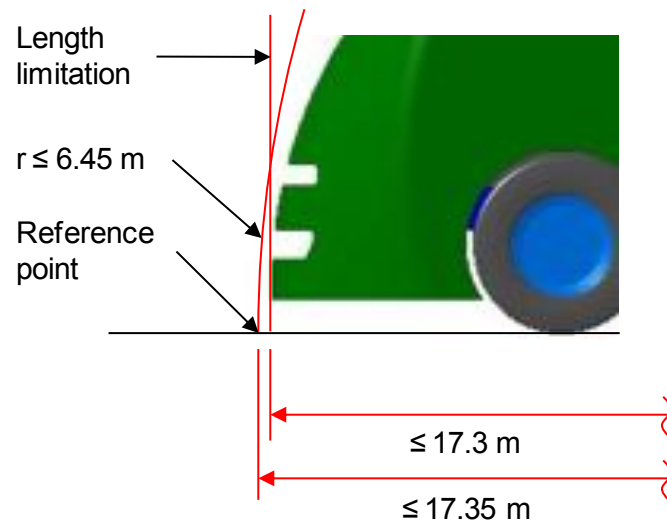


Fig. 9-2: Length limitation and position of reference point for examination geometry

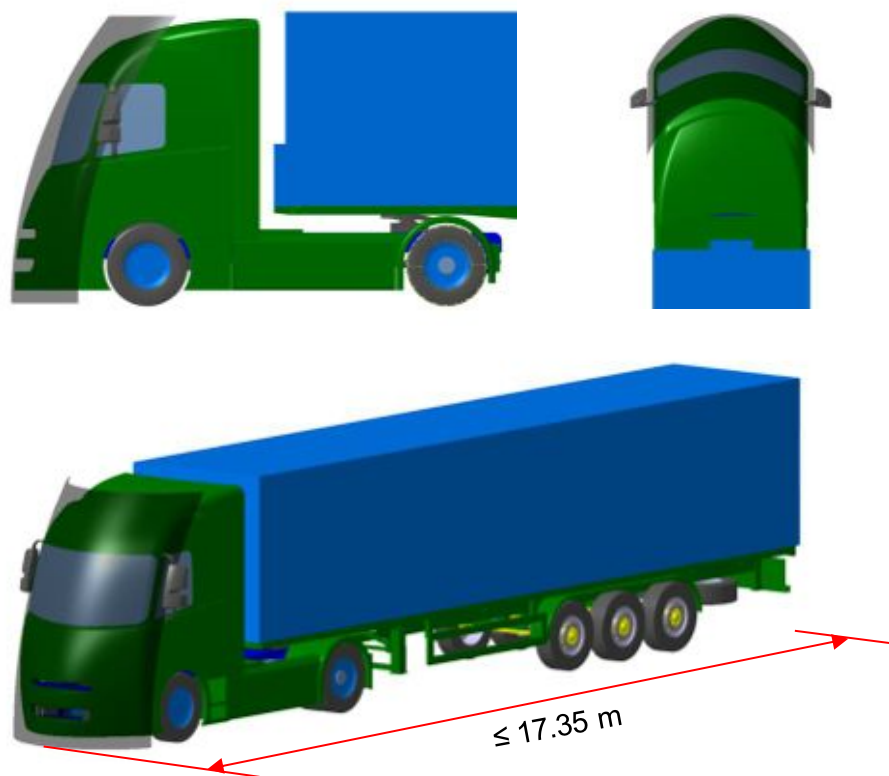


Fig. 9-3: Examination geometry

To implement these suggestions in future regulations the following changes are recommended:

1. Total length limit shall be raised in 96/53/EC, ANNEX 1, point 1.1: Change “16.50 m” to “17.30 m”.
2. An additional point shall be integrated into 96/53/EC, ANNEX 1, point 1.1: No point of the vehicle shall project beyond an examination geometry that is defined as follows:
 - a. Two circles span the surface of the examination geometry.
 - b. The first circle is located on the street plane. The radius of the circle is 1.45 m. The centre point is located on the centre plane of the vehicle.
 - c. The second circle is located on the centre plane of the vehicle. The radius of the circle is 6.45 m. The centre point is located on the street plane.
 - d. Both circles intersect at a reference point. This point is located 5 cm in front of the foremost point of the vehicle in the street plane and in the centre plane of the vehicle.

9.2 Material Usage

The initial contact between the truck front and a VRU in case of an accident has big influence on the accident consequences. Hence an energy absorbing zone is required. Regarding the head impact the minimal energy absorption length should be 68 mm to assure that limiting values are not exceeded [KÜH07]. Therefore a zone of this length behind all non transparent exterior parts on the front should be reserved for energy absorbing materials.

9.3 Direct Vision

The suggested design changes may not result in an aggravation of the direct vision of the truck driver. To achieve this it is recommended to work out a regulation for the direct field of view of trucks similar to the ECE-R 125 that currently only applies for passenger cars.

10 Summary and Outlook

The main requirements for trucks are to provide a maximum of cargo space and to carry a maximum of payload. The upper limits for these values, e.g. an overall length of 16.5 m length and 40 t of gross weight, are set by current European Union Regulations. These boundary conditions lead to a flat front design of tractors that has disadvantages regarding safety and aerodynamic issues. The focus of this study is to analyse, what benefits regarding fuel consumption and safety can result from rounding the front shape of tractors. The required design space for this was provided by an increase of the maximum semi-trailer combination length.

As a basis for the study, an analysis of state-of-the-art semi-trailer tractors, close to series concept trucks and future design concepts was executed. In addition regulations and directives with regard to the design of the truck front were investigated. The key learnings from that were used for the build-up of a generic CAD model of a reference truck. After this, three optimised base concepts were derived. The base concepts had different length extensions of 400 mm, 800 mm and 1200 mm. In the 800 mm and the 1200 mm extended concept also the position of the front axle and the entrance steps was re-arranged, to assure a sufficient approach angle and comfortable ingress and egress. A pre-assessment of these base concepts concerning aerodynamic performance, compliance of axle loads and manoeuvrability revealed that the 800 mm extended concept forms the best compromise. Due to this it was selected to undergo a second optimisation loop to further improve its aerodynamic properties. Finally, an improvement of the c_D value of more than 12 % compared to the reference truck was proven in CFD simulation. This effects a reduction of fuel consumption by 3.2 % to 5.3 % depending on the gross weight of the vehicle. If this reduction of fuel consumption is associated to overall annual fuel consumption of HGVs a total saving of 856 to 1400 million litres of fuel and 2.3 to 3.8 million tons of CO₂ emissions accordingly can be achieved.

Crash simulations showed that the rounded front shape has advantages in terms of safety. Three load cases were defined for this reason. First, simulations of accidents involving pedestrians and cyclist were executed. It was observed that the rounded front shape of the advanced concept has a deflective effect for pedestrians after the initial contact in an accident. For this reason an overrun of the accident partner was prevented in 100 % of the advanced concept simulations, whereas simulations of the reference model lead to an overrun in 70 % of the simulated cases. In the second load case the tractor crashed into a trailer standing in front of it to reproduce the accident scenario of a truck hitting another truck from behind. These simulations revealed that the advanced concept provides an enhanced self protection performance. Intrusions at the tractors front were reduced by approximately 40 mm. The third load case was set up to evaluate the partner protection performance. In a scenario of a passenger car hitting the tractor frontally, higher intrusions into the car compared to the reference were detected. This occurs, because the initial contact area of the car and the front of the advanced concept is smaller than the contact area of the car and the reference tractor front, which leads to higher local loads and an uneven absorption of the

crash energy. Hence an additional crash management system was applied to the free design space in the front of the advanced concept. By means of this system the intrusions were reduced below the reference values, so the partner protection performance was improved.

This study shows that changes of current regulations can lead to a significant improvement of efficiency and road safety of trucks. For that reason recommendations with regard to future legislation based on the results of the investigations were derived.

The presented results base on a holistic approach. Due to this the level of detail is limited in some points of the analysis. It is preferable to execute further researches to fully realise the disclosed potential. A more detailed investigation of the crash management system, for example, can result in additional enhancement of the crash behaviour. Furthermore it should be examined whether further refinement of the vehicle front can determine supplemental increase of efficiency.

11 Formula Symbols and Indices

c_D Aerodynamic drag coefficient

c_T Tangential force coefficient

G_{Tractor} Weight force of the tractor

G_{Trailer} Vertical trailer load on the fifth-wheel plate

F_{Front} Front axle load of the tractor

F_{Rear} Rear axle load of the tractor

l_{WB} Wheelbase of the tractor

l_{Tractor} Distance between the centre of gravity of the tractor and its rear axle

l_{Trailer} Distance between the centre of gravity of the tractor and its fifth-wheel plate

r Curvature radius

12 Literature

- [ARA10] N. N.
ARAL Preisdatenbank
<http://www.aral.de/toolserver/retailleurope/histFuelPrice.do?categoryId=4001137&contentId=58611>
ARAL, 2010
- [AUT07] ROTH, D.
Wheeled Spaceship - Volvo BeeVan concept
<http://www.autoblog.com>
Autoblog, 2007
- [AVD10] N. N.
Automobilclub von Deutschland (AvD)
<http://www.avd.de/startseite/service-news/benzinpreise/benzinpreise-in-europa/preise-fuer-dieselmotoren/>
2010
- [BAA08] BAAKE, U.
Industrielle Nutzfahrzeugentwicklung in globalen Märkten
Lecture at RWTH Aachen University
Institut für Kraftfahrzeuge, Aachen, 2008
- [BAC09] BACHEM, H.; GUSERLE, S.
MAN TGX/TGS – Active and Passive Safety
MAN Nutzfahrzeuge AG
18. Aachener Kolloquium Fahrzeug und Motorentechnik,
RWTH Aachen University, Aachen, 2009
- [BER09] BERGER, L.; LESEMANN, M.; SAHR, C.
SuperLIGHT-CAR - the Multi-Material Car Body
7th European LS-DYNA Conference, Salzburg, Österreich, 2009
- [CAR10] N. N.
Cartwright Cheetah
<http://www.cartwright-group.co.uk>
The Cartwright Group, Cheshire, 2010
- [CAR11] N. N.
SafetyCompanion 2011
carhs.training gmbh, 2011

- [DAF10] N. N.
Imagebank
<http://www.daftrucks.com>
DAF Trucks N.V., Eindhoven, 2010
- [DAI10a] N. N.
Nutzfahrzeuge
<http://www.mercedes-benz.de>
Daimler AG, Stuttgart, 2010
- [DAI10b] N. N.
Mercedes-Benz Econic
Booklet
http://www.mercedes-benz.de/content/germany/mpc/mpc_germany_website/de/home_mpc/truck_home/home/trucks/econic/news/econic_booklets.html, 2010
Daimler AG, Stuttgart, 2010
- [DEK09] N. N.
Verkehrssicherheitsreport LKW 2009
Strategien zur Unfallvermeidung auf den Straßen Europas
DEKRA Automobil GmbH, 2009
- [DEK10] N. N.
Aktuelle Crashtestberichte
MAN gegen VW Golf
<http://www.dekra.de>
DEKRA e.V., Stuttgart, 2010
- [DOD09] DODD, M.
Follow up study to the heavy goods vehicle blind spot modeling and reconstruction trial
<http://trl.co.uk>
Transport Research Laboratory, Wokingham, 2009
- [DON10] N. N.
The Don-Bur Teardrop Trailer
<http://www.donbur.co.uk>
Don-Bur Ltd., Stoke-on-Trent, 2010
- [EAA02] N. N.
Aluminium at European Road Transport Shows
Aluminium Quarterly Report, 1st / 2nd quarter 2002
European Aluminium Association, Brussels, 2002

- [ECX03] N. N.
2003/19/EC - Masses and Dimensions
Directives of the European Parliament
<http://eur-lex.europa.eu>
Publications Office of the European Union , Luxembourg, 2003
- [ECX09] N. N.
661/2009/EC - Type-approval Requirements
Directives of the European Parliament
<http://eur-lex.europa.eu>
Publications Office of the European Union , Luxembourg, 2009
- [ECX96] N. N.
96/53/EC - Masses and Dimensions
Directives of the European Parliament
<http://eur-lex.europa.eu>
Publications Office of the European Union , Luxembourg, 1996
- [ECX97] N. N.
97/27/EC - Masses and Dimensions
Directives of the European Parliament
<http://eur-lex.europa.eu>
Publications Office of the European Union, Luxembourg, 1997
- [ECE08] N. N.
ECE-R 48 - Lighting installation
Regulations of the UN Economic Commission for Europe (ECE)
<http://www.unece.org>
UN Economic Commission for Europe, Switzerland, 2008
- [ECE88] N. N.
ECE-R 73 - Lateral protection of goods vehicles, trailers and semi-trailers
Regulations of the UN Economic Commission for Europe (ECE)
<http://www.unece.org>
UN Economic Commission for Europe, Switzerland, 1988
- [ECE93] N. N.
ECE-R 29 - Pendulum test for cabins Regulations of the UN Economic
Commission for Europe (ECE)
<http://www.unece.org>
UN Economic Commission for Europe, Switzerland, 1993

- [ECE94] N. N.
ECE-R 93 - Front underrun protective devices
Regulations of the UN Economic Commission for Europe (ECE)
<http://www.unece.org>
UN Economic Commission for Europe, Switzerland, 1994
- [EEC77] N. N.
77/389/EEC Towing-devices
Directives of the European Parliament
<http://eur-lex.europa.eu>
Publications Office of the European Union , Luxembourg, 1977
- [EEC89] N. N.
89/461/EEC - Modification of the directive 85/3/EEC
Directives of the European Parliament
<http://eur-lex.europa.eu>
Publications Office of the European Union , Luxembourg, 1989
- [EMO10] N. N.
Double-deck Cargo for Increased Efficiency
Emons Cargo B.V., Beuningen, 2010
- [ERS08] European Road Safety Observatory
Traffic Safety Basic Facts 2008
Heavy Goods Vehicles and Buses
http://erso.swov.nl/safetynet/fixe/WP1/2008/BFS2008_SN-INTRAS-1-3-HGVs.pdf
- [EUR10] N. N.
Europäische Kommission
eurostat Verkehrsdatenbank
http://epp.eurostat.ec.europa.eu/portal/page/portal/statistics/search_database
- [FAS08] FASSBENDER, S.; HAMACHER, M.
Modification of a Truck Front for Improved Kinematics in Run Over Accidents
APROSYS Final Workshop. May 7th, 2008
- [GIL04] GILMONT, B.
Aluminium improves transport safety
Texts and illustrations for the European transport press
Press Information, European Aluminium Association, 2004
- [GOE09] GOEDE, M.
SuperLightCar: Sustainable Production Technologies for CO₂ Emission Reduced
Lightweight Car Body Concepts, 2009

- [GUG09] GUGLER, J.; FEIST, F.; FASSBENDER, S.
Guidelines for integrated designated evaluation of advanced vulnerable road user protection systems
TU Graz, Graz, 2009
RWTH Aachen University, Aachen, 2009
- [GRS10] N. N.
ECE/TRANS/WP.29/GRSG/2010/9 Indirect vision
Proposals for Global technical regulations (gtrs) of the UN Economic Commission for Europe (ECE)
<http://www.unece.org>
UN Economic Commission for Europe, Switzerland, 2010
- [HAM09] HAMACHER, M.; FASSBENDER S.; FEIST, F.; GUGLER, J
Modification of a Truck Front for Improved Kinematics in Run Over Accidents
APROSYS, Paper Number 09-0458
- [HAH03] HAHN, M.
Scania launches new crash-zone concept for trucks
Scania AB, Södertälje, 2003
- [HAR10] HARTUNG, C.-F.
Lightweight technology
<http://volvo.qbrick.com/player.aspx?mid=330&cid=1>
Volvo Truck Corporation, Gothenburg, 2010
- [HDV05] N. N.
Heavy Duty Vehicles eSafety Working Group
Final Report of Heavy Duty Vehicles Working Group
Activity report for the year 2004
Brussels, October, 2005
- [HEL05] HELMS, H.; LAMBRECHT, U.
Energy savings by light weighting for European articulated trucks
Final Report
IFEU-Institute, Heidelberg, 2005
- [HOC10] N. N.
3-Achs-Auflieger
<http://www.hohenkirchner-nutzfahrzeuge.de>
Hohenkirchner Nutzfahrzeuge Service GmbH, Hohenkirchen, 2010

- [HOE06a] HOEPKE, E.
Anhängertechnik
Teil 1: 1930 bis 1980
Springer Automotive Media, Wiesbaden, 2006
- [HOE06b] HOEPKE, E.
Anhängertechnik
Teil 2: 1980 bis heute
Springer Automotive Media, Wiesbaden, 2006
- [HOE08] HOEPKE, E.; BREUER, S.; APPEL, W.; BRÄHLER, H.; ESCH, T.; KOPP, S.
Nutzfahrzeugtechnik
GWV Fachverlage GmbH, Wiesbaden, 2008
- [HUC08] HUCHO, W. H.
Aerodynamik des Automobils
GWV Fachverlage GmbH, Wiesbaden, 2008
- [HYM02] N. N.
Aero-Safety-Truck 2002
<http://www.hymer-idc.de>
Hymer IDC, Pforzheim, 2002
- [IRU06] International Road Transport Union
A Scientific Study
"ETAC" European truck Accident Causation, 2006
http://ec.europa.eu/transport/roadsafety_library/publications/etac_final_report.pdf
- [ITF10] N. N.
International Transport Forum
<http://www.internationaltransportforum.org>
International Transport Forum (OECD), Paris, 2010
- [IVE07a] N. N.
Stralis. Die neue Dimension im Transport.
Iveco Magirus AG, Ulm, 2007
- [IVE07b] N. N.
Sparsam durch den Wind
Ivecos Transport Concept zeigt Spritspar-Potenziale
Nutzfahrzeug Management, Beverstedt, 2007

- [KRO09] N. N.
Eco Liner
<http://www.nutzfahrzeuge.krone.de>
Fahrzeugwerk Bernard KRONE GmbH, Werlte, 2009
- [KÜH07] KÜHN, M.; FRÖMING, R.; SCHINDLER, V.
Fußgängerschutz
Unfallgeschehen, Fahrzeuggestaltung, Testverfahren
Springer-Verlag Berlin Heidelberg, 2007
- [LAS03] N. N.
Aero-Safety-Truck
Lastauto Omnibus, ETM Verlags- und Veranstaltungs-GmbH, Stuttgart, 2003
- [LAS04] N. N.
Renault Radiance – Die Zukunft hat begonnen
Lastauto Omnibus, ETM Verlags- und Veranstaltungs-GmbH, Stuttgart, 2004
- [MAI09] MAIERHOFER, B.
Der 1-Liter LKW
Mitglied des Vorstands der MAN Nutzfahrzeuge AG
VDA, 11. Technischer Kongress
25. Und 26. März 2009
- [MAN09] N. N.
MAN TGX.
Der Maßstab im Fernverkehr
MAN Nutzfahrzeuge Group, Munich, 2009
- [MES06] MESINA, C. T., et al
Characteristics of Heavy Trucks Versus Pedestrians and/or Cyclists
APROSYS SP8.3 Deliverable D8.3.5.
Dutch Organisation for Applied Scientific Research (TNO), 2006
- [MEK10] N. N.
Field of vision
<http://www.mekra.de/Sichtfeld.92.0.html>
MEKRA Lang GmbH & Co. KG, Fürth, 2010
- [MOT11] N. N.
Mercedes-Benz – Actros
http://www.motornews.eu/cms/front_content.php?idcatart=23009
motornews onlineservice i.G., Schwarzach, 2011

- [NEW08] N. N.
Space Truck von Luigi Colani kommt an die SuisseEMEX'08
<http://www.news.ch>
News.ch, St. Gallen, 2008
- [OST92] OSTERMANN, F.; et al
Aluminium-Werkstofftechnik für den Automobilbau
expert verlag, 1992
- [PAL09] PALETHORPE, A.
Major Project - Truck Cab
<http://www.palethorpedesign.co.uk>
Palethorpe Design, Birmingham, 2009
- [REN08] N. N.
Optifuel Solutions Generation 2010
<http://www.pressebox.de>
Renault Trucks Deutschland GmbH, Bruehl, 2008
- [REN10] N. N.
Renault Trucks in Deutschland
<http://www.renault-trucks.de>
Renault Trucks, 2010
- [SCA02] N. N.
Die Zukunft des Haubers: Scania STAX – Konzept-Hauber der Zukunft
<http://www.scania.de>
Scania Deutschland GmbH, Koblenz, 2002
- [SCA10] N. N.
Image Bank
<http://www.scania.com>
Scania AB, Södertälje, 2010
- [SCB10] N. N.
S.CS UNIVERSAL
Schmitz Cargobull AG, Horstmar, 2010
- [SCH06] SCHRAM, R.
Car-to-Truck Testing and Simulations
<http://vc-compatible.rtdproject.net>
VC-COMPAT, Eindhoven, 2006

- [SCH08] SCHALLER, V.
Nachhaltigkeit im Straßengüterverkehr
Sicht eines Fahrzeugherstellers
MAN Nutzfahrzeuge AG
Symposium "Nachhaltigkeit im Straßengüterverkehr", Frankfurt, 2008
- [SMI05] SMITH, T.; KNIGHT, I.
Summary of UK accident data
APROSYS Report AP-SP21-0036
APROSYS, Brussels, 2005
- [STÜ07] STÜRZEBECKER, V.
Volvo Rolling Steel
<http://www.volvotrucks.com>
Volvo Trucks Region Central Europe GmbH, Ismaning, 2007
- [TGX10] N. N.
TGX EcoLion
Extremely economical. Superbly safe.
MAN Nutzfahrzeuge, Munich, 2010
- [TRA03] N. N.
TRANS/WP.29/AC.3/4 Installation of Lighting and Light-Signalling Devices
Proposals for Global Technical Regulations (GTR) of the UN Economic
Commission for Europe (ECE)
<http://www.unece.org>
UN Economic Commission for Europe, Switzerland, 2003
- [TRA05] N. N.
TRANS/WP.29/AC.3/11 Masses and Dimensions
Proposals for Global technical regulations (gtrs) of the UN Economic Commission
for Europe (ECE)
<http://www.unece.org>
UN Economic Commission for Europe, Switzerland, 2005
- [TRL10] ROBINSON, B. J.; HULSHOF, W.; ROBINSON, T.; KNIGHT, I.
AEBS and LDWS exemptions study: draft final report
http://circa.europa.eu/Public/irc/enterprise/automotive/library?l=/mvwg_vehicles_working/116th_meeting_2010/ldws_draft290610pdf/_EN_1.0_&a=d
TRL, 2010

- [ULS98] N. N.
ULSAB Engineering Report
6. CAE Analysis Results
WorldAutoSteel
http://www.worldautosteel.org/uploaded/2_2_6_ULSAB_EngRpt_CAEEAnalRes.pdf, 1998
- [UTA05] N. N.
Front underride protection / rear underride protection
UTAC Gothenburg
Workshop Gothenburg, Gothenburg, 2005
- [VER09] N. N.
Erlkönig: Die nächste Daimler-Generation
Verkehrsrundschau Online
<http://www.verkehrsrundschau.de>
Springer Fachmedien, Munich, 2009
- [VOL10a] N. N.
Images and Videos
<http://www.volvotrucks.com>
Volvo Truck Corporation, Gothenburg, 2010
- [VOL10b] N. N.
Super-light trucks
<http://www.volvotrucks.com>
Volvo Truck Corporation, Gothenburg, 2010
- [VOL10c] N. N.
Volvo - Safety
Nobody Has Crashed
<http://www.volvo.com>
Volvo Truck Corporation, Gothenburg, 2010
- [VTN09] N. N.
TruckNews0309
Willkommen in der Crash-Fabrik
<http://www.volvo.com>
Truck News, Ismaning, 2009
- [WAL07] WALLENTOWITZ, H.
Vorstellung der wissenschaftlichen Begleitstudie zum Feldversuch des verlängerten Aufliegerkonzeptes
Institut für Kraftfahrwesen, Aachen, 2007

- [WAN05] WANG, W.
Review of accident data
APROSYS, Sub Task 2.1.1.1 Summary Report AP-SP21-0036
APROSYS, Brussels, 2005
- [WIN10] WINTER, M.; PUCHNER, K.; PRENNINGER, K.
Concept of a Lightweight Heavy Truck Frame for Increased Transportation
Efficiency
MAGNA Engineering Center Steyr GmbH & Co KG
4. Grazer Nfz Workshop
TU Graz, Graz, 2010
- [WOL10] WOLFSGRUBER, A.
Nutzfahrzeugdesign im 21. Jahrhundert
Szenarien, Trends und Utopien im Truckdesign
MAGNA STEYR Fahrzeugtechnik
4. Grazer Nfz Workshop
TU Graz, Graz, 2010

13 Appendix

13.1 CFD Simulations

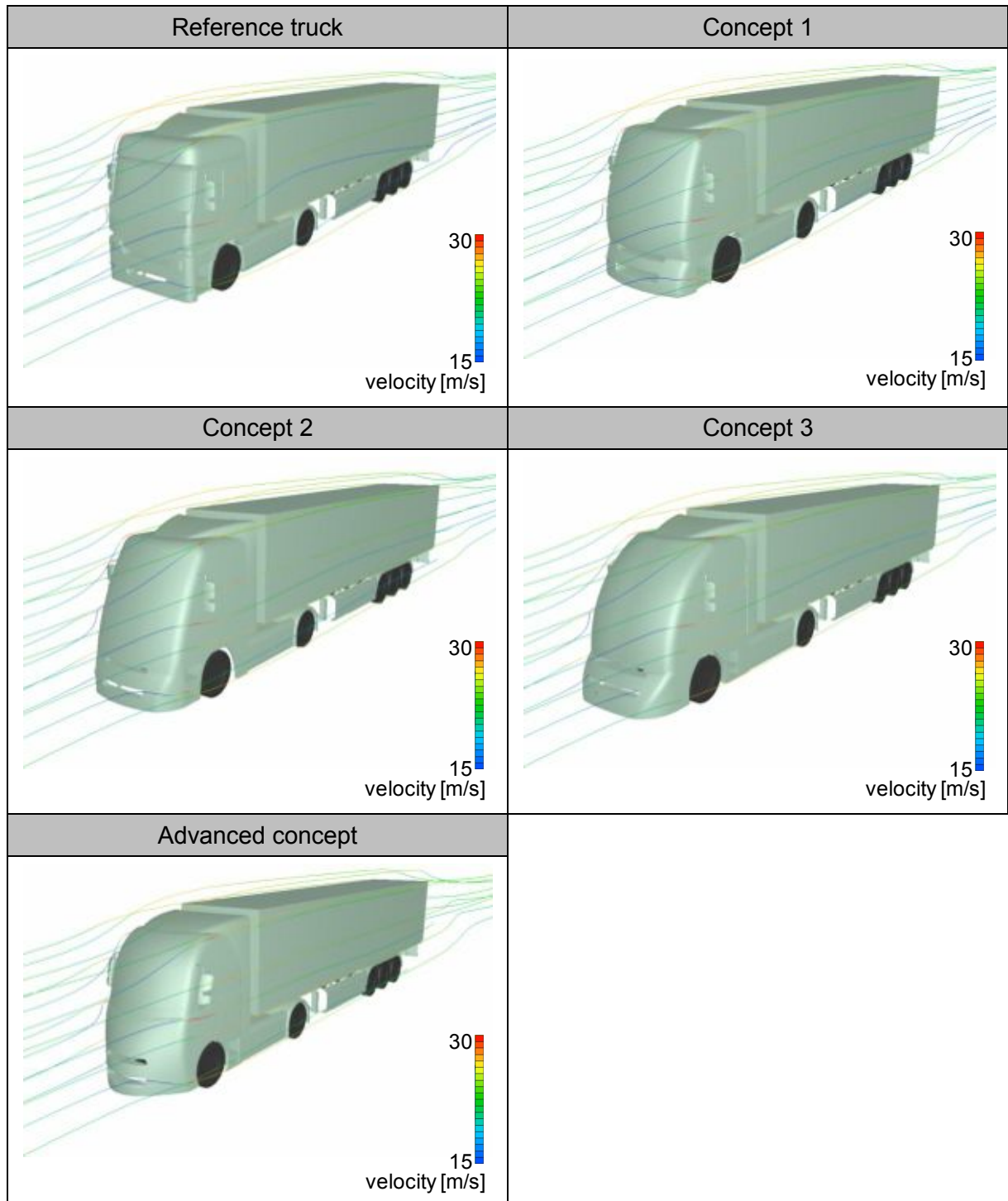


Fig. 13-1: Velocity in the streamlines

13.2 Partner Protection Simulations

13.3 Frontal Collision without Offset

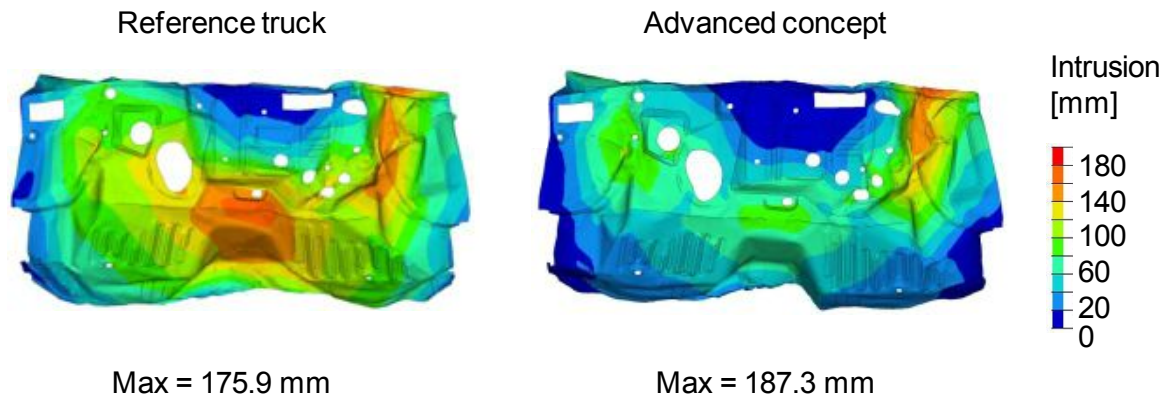


Fig. 13-2: Intrusions into the car's firewall after the crash

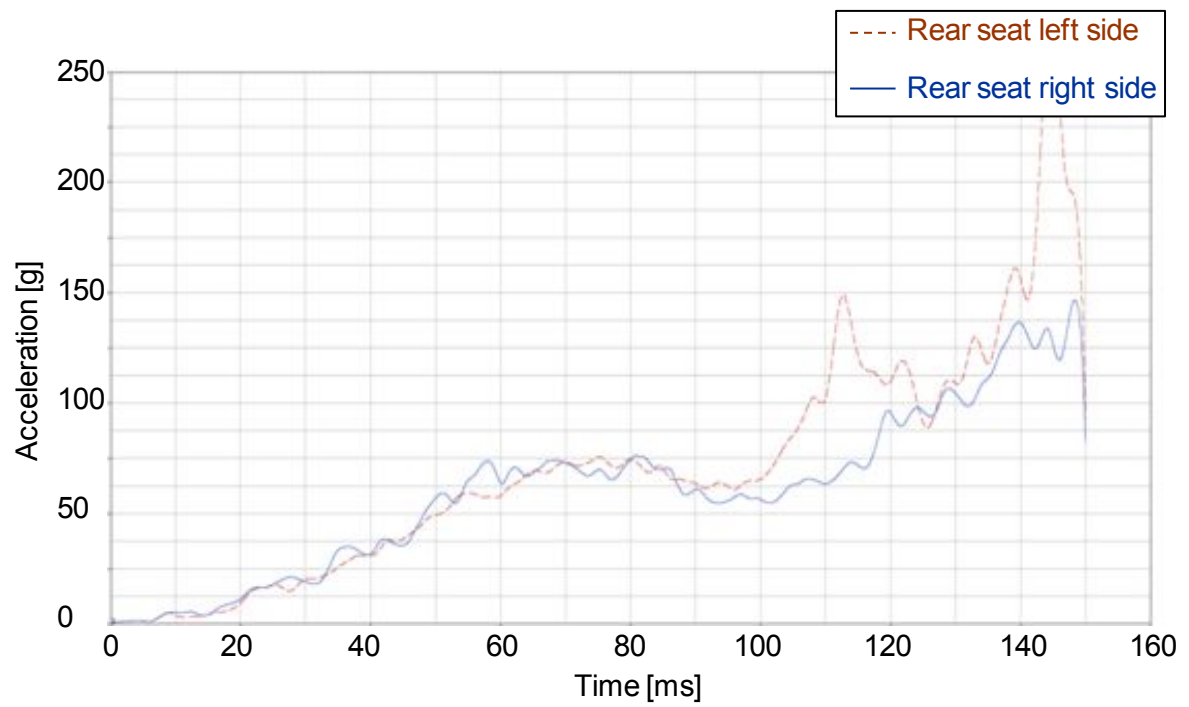


Fig. 13-3: Acceleration at the car's rear seats during the crash with the reference truck

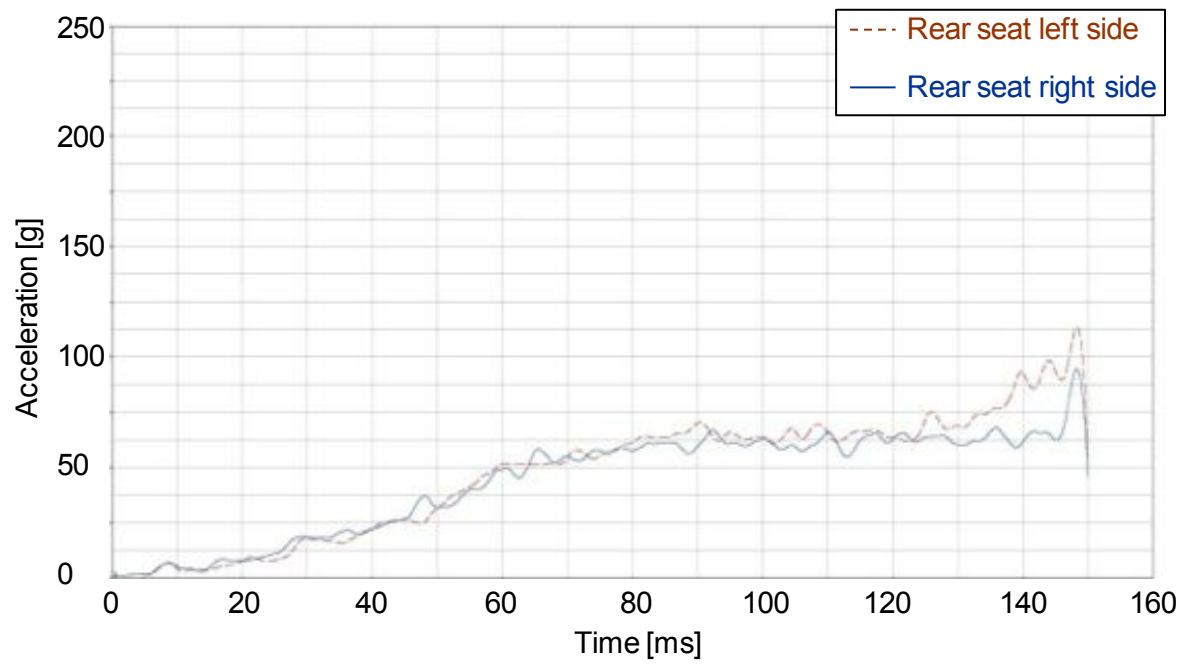


Fig. 13-4: Acceleration at the car's rear seats during the crash with the advanced concept

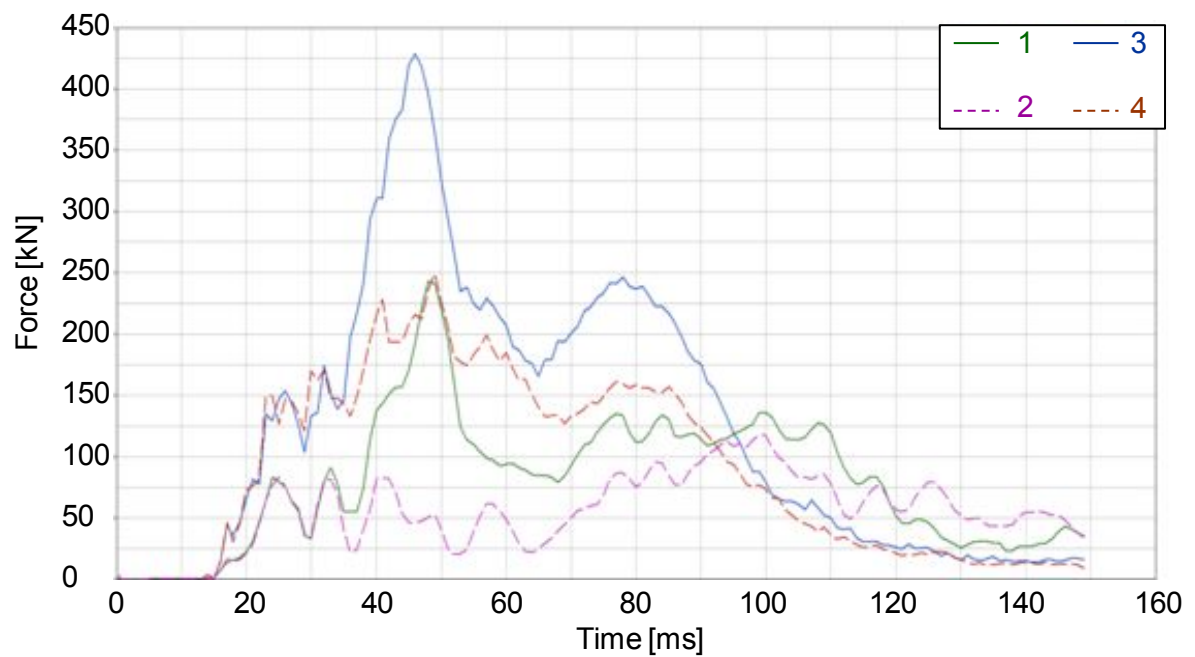


Fig. 13-5: Forces in the side members of the reference truck

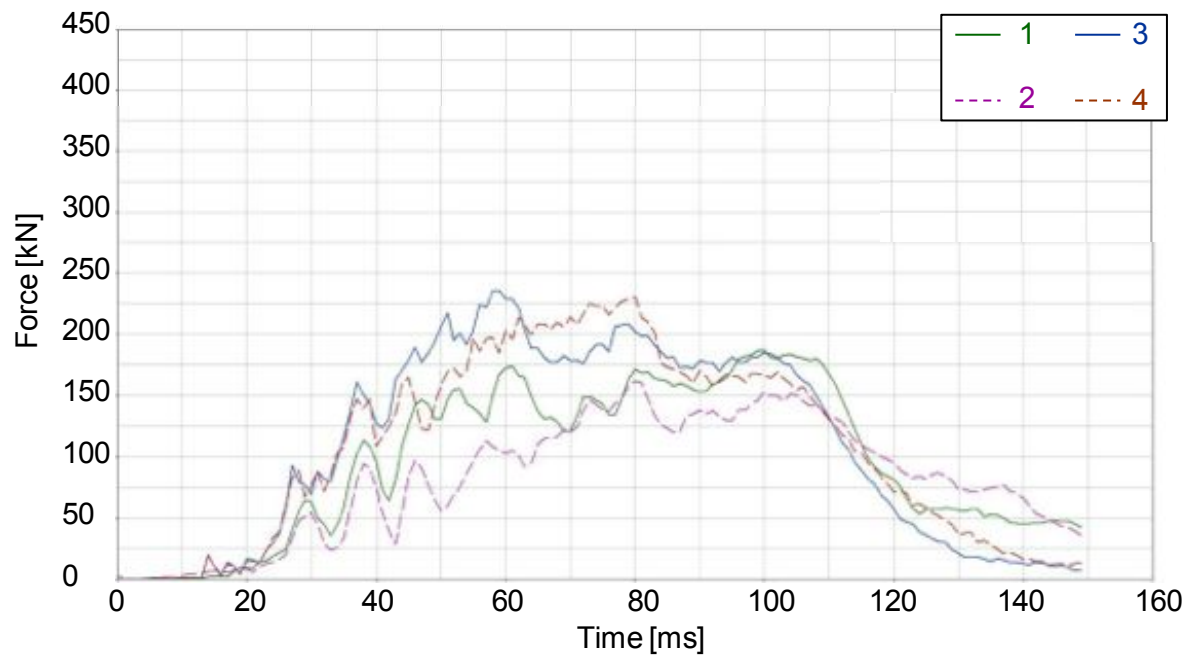


Fig. 13-6: Forces in the side members of the advanced concept

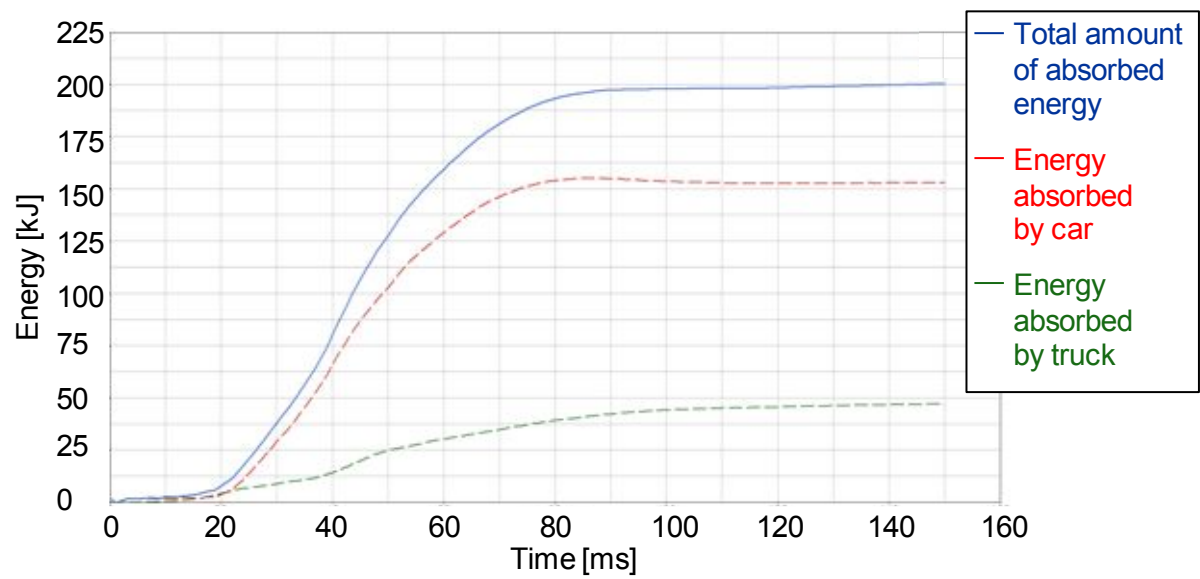


Fig. 13-7: Energy absorption behaviour of reference truck

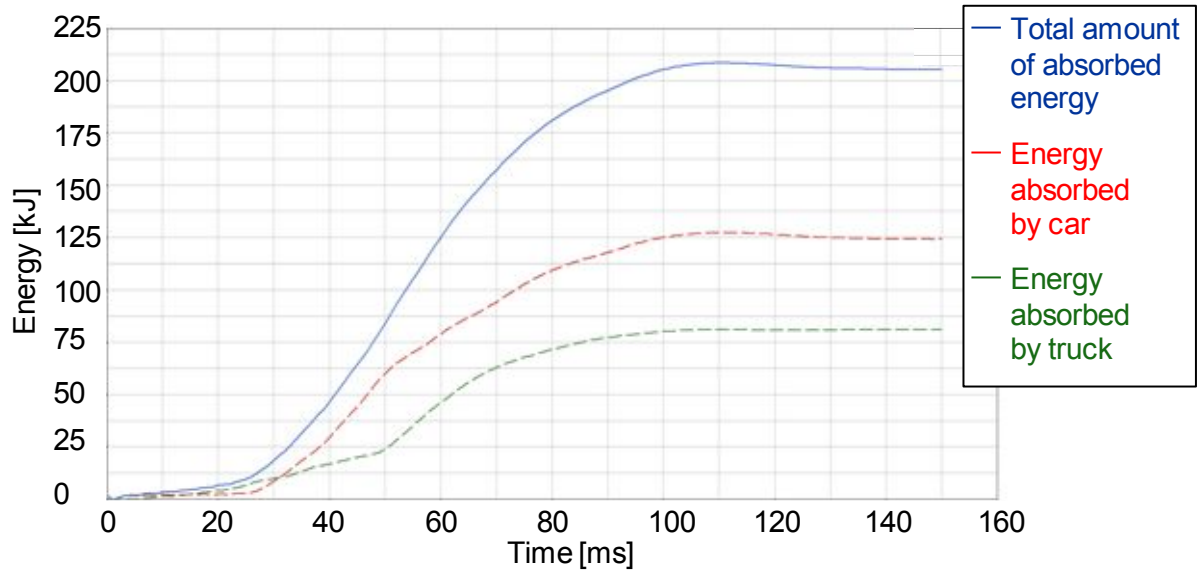


Fig. 13-8: Energy absorption behaviour of the advanced concept

13.4 Rear Shunt

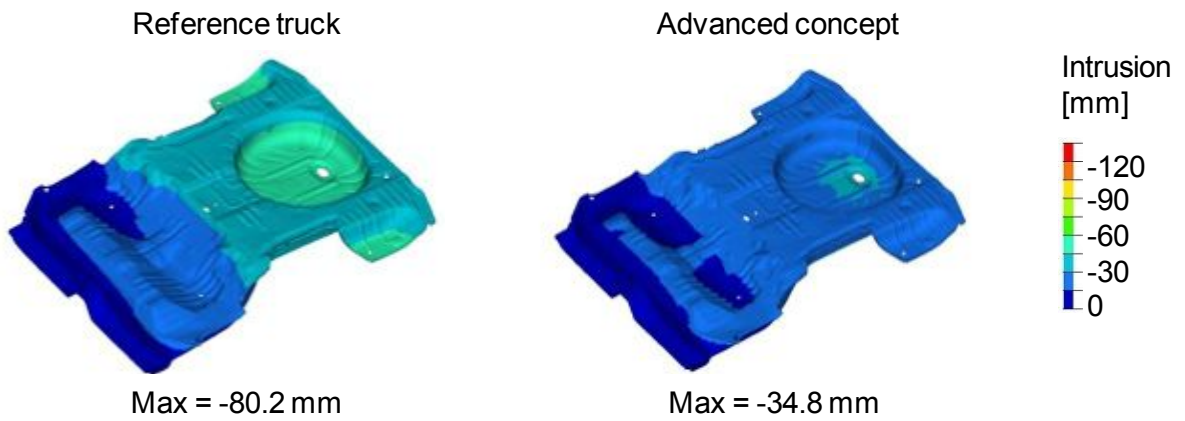


Fig. 13-9: Intrusions into the car's rear bottom panel

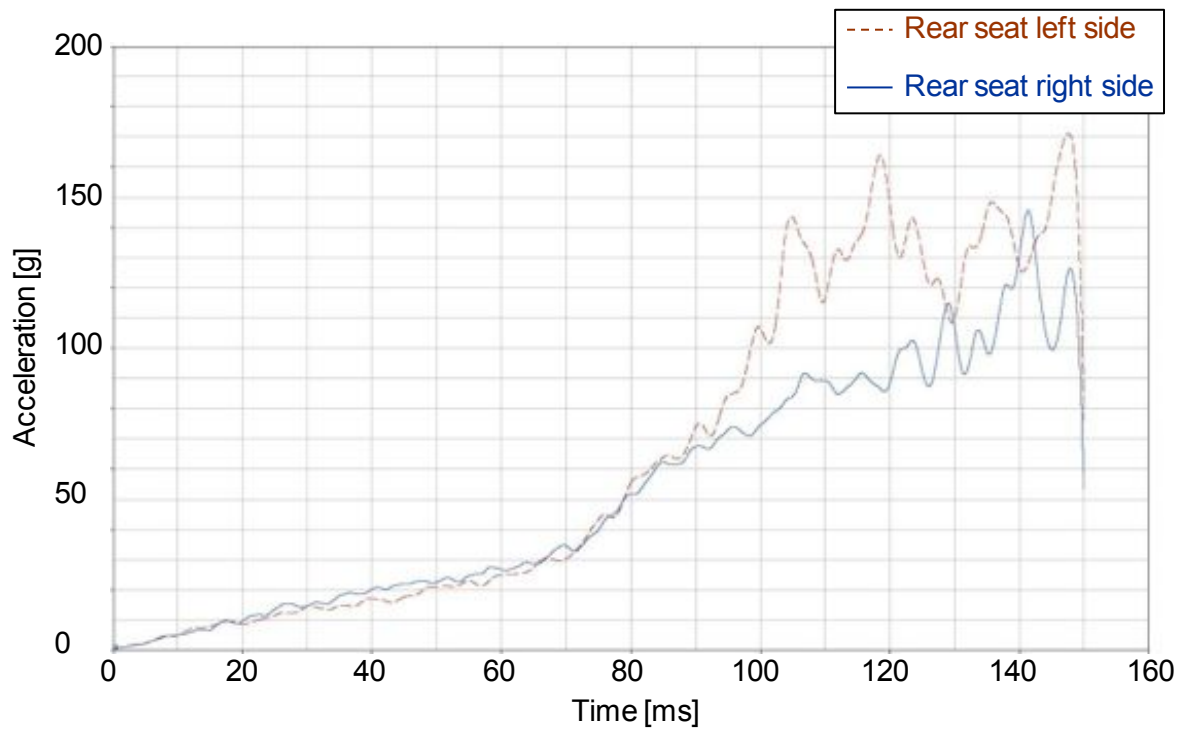


Fig. 13-10: Acceleration at the car's rear seats during the crash with the reference truck

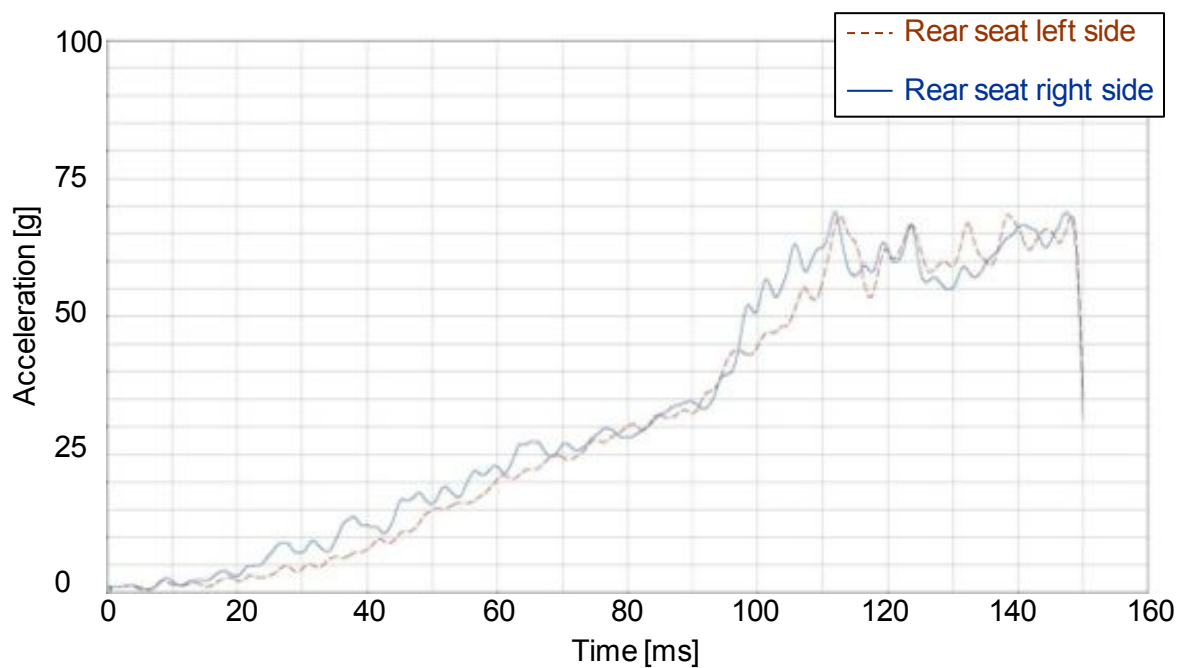


Fig. 13-11: Acceleration at the car's rear seats during the crash with the advanced concept

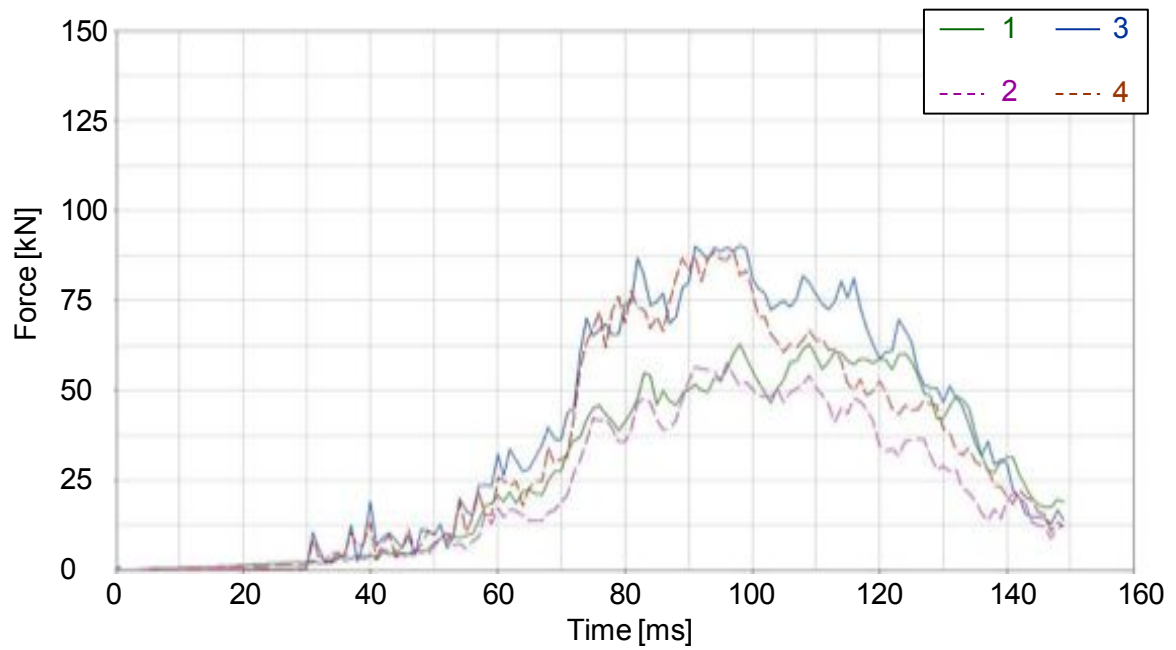


Fig. 13-12: Forces in the side members of the reference truck

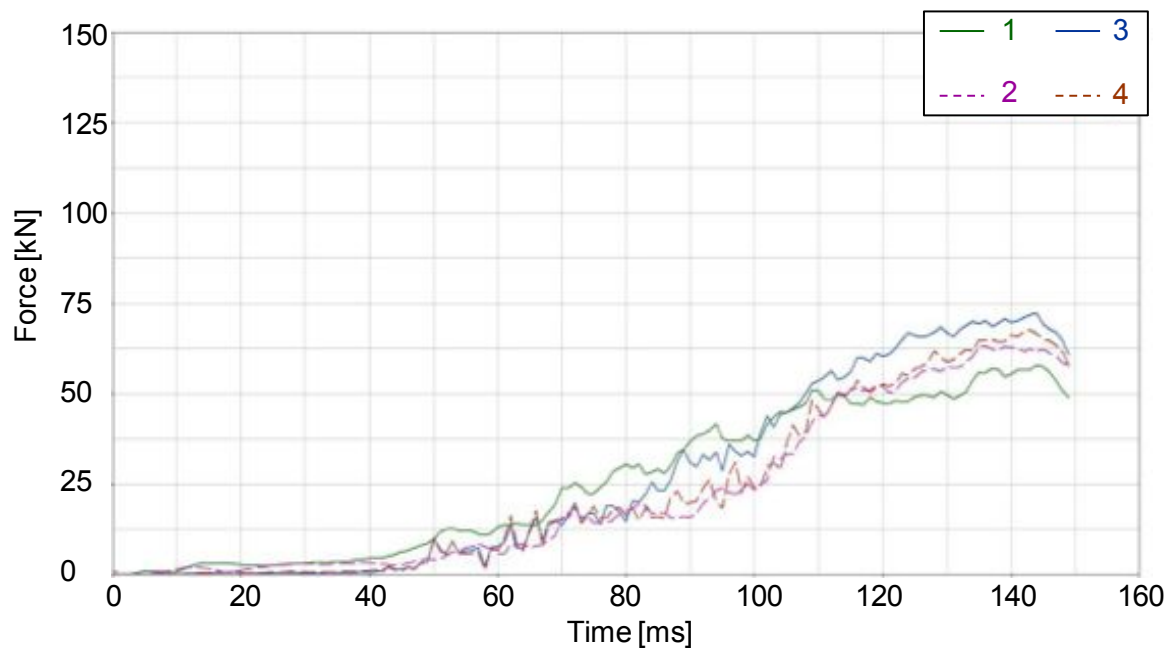


Fig. 13-13: Forces in the side members of the advanced concept

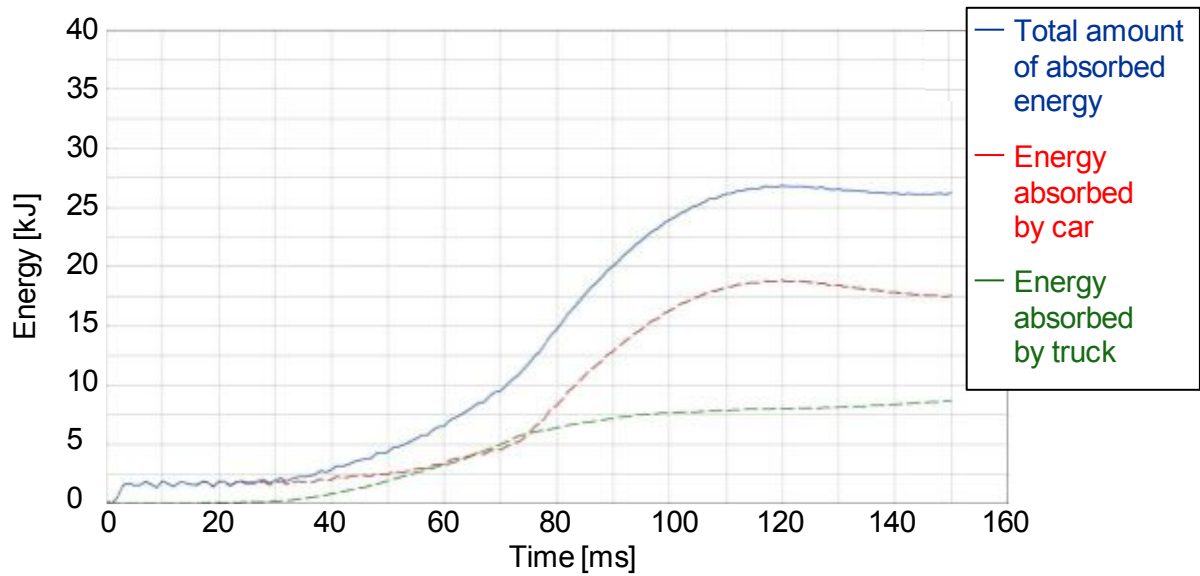


Fig. 13-14: Energy absorption behaviour of reference truck

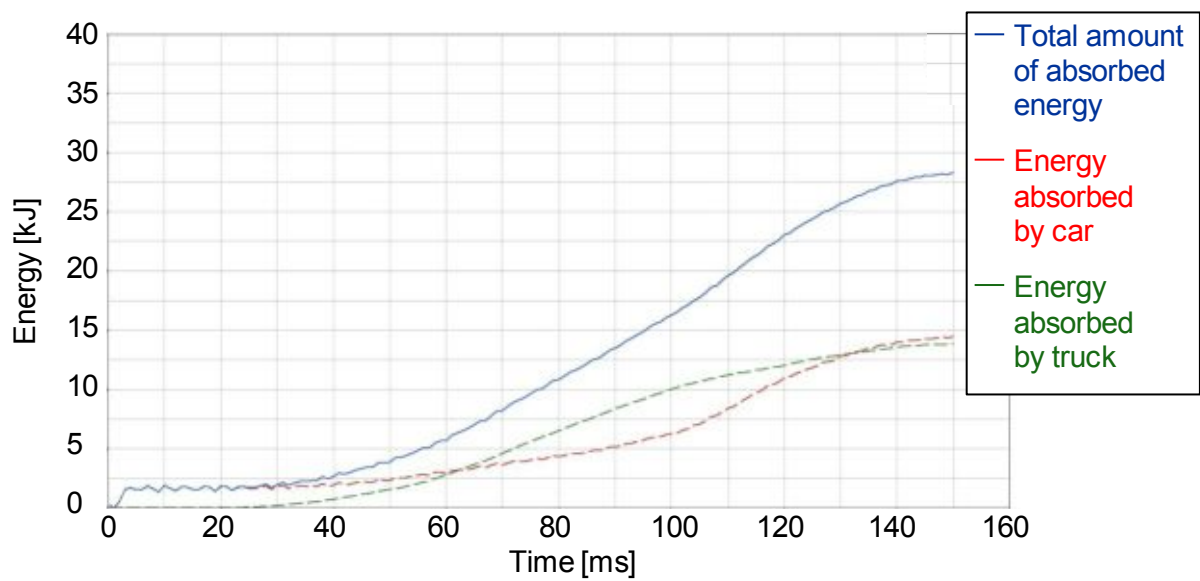


Fig. 13-15: Energy absorption behaviour of the advanced concept

13.4.1 VRU Protection Simulations

13.4.2 Reference Tractor: Central Impact

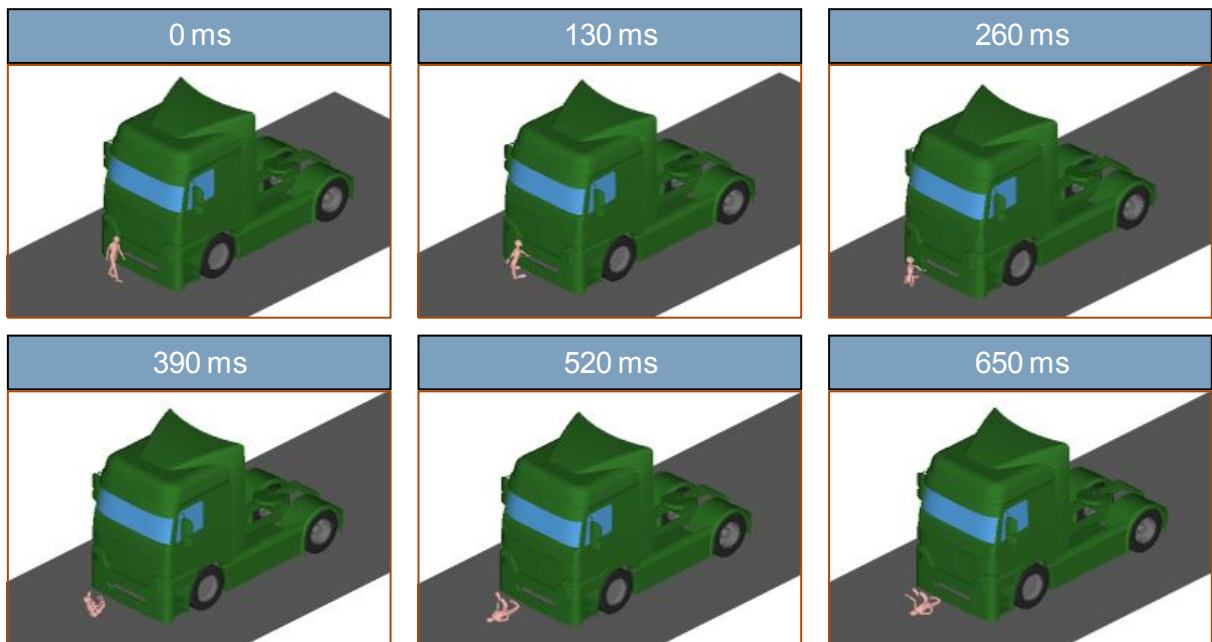


Fig. 13-16: Reference tractor against 6 year old child

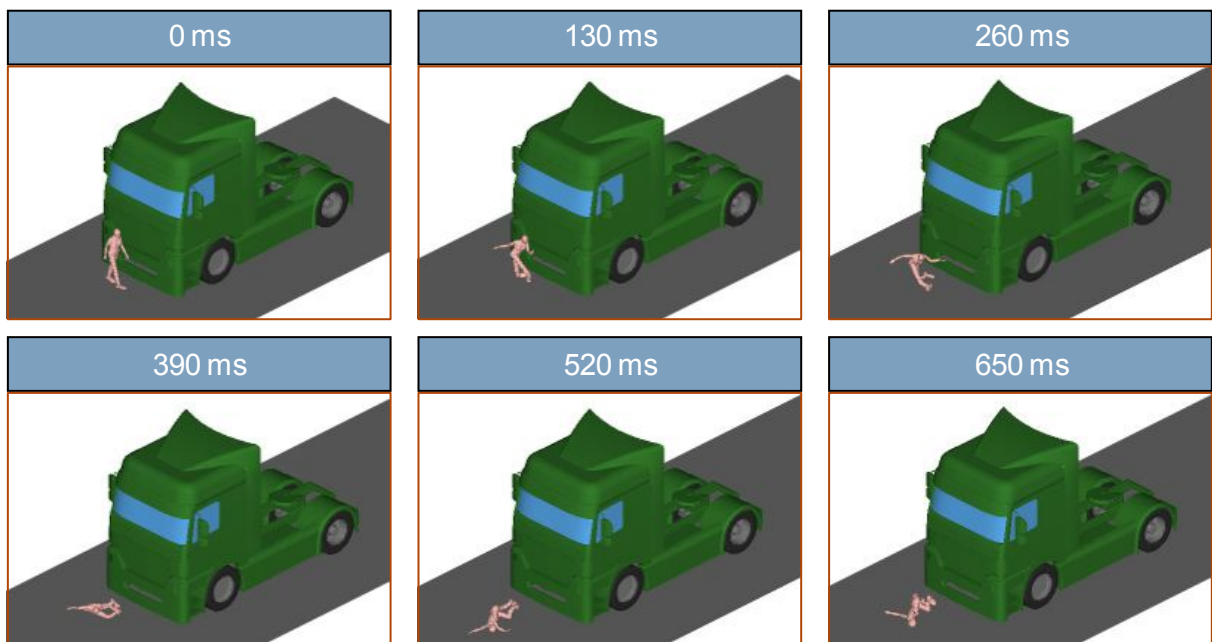


Fig. 13-17: Reference tractor against 5 % female

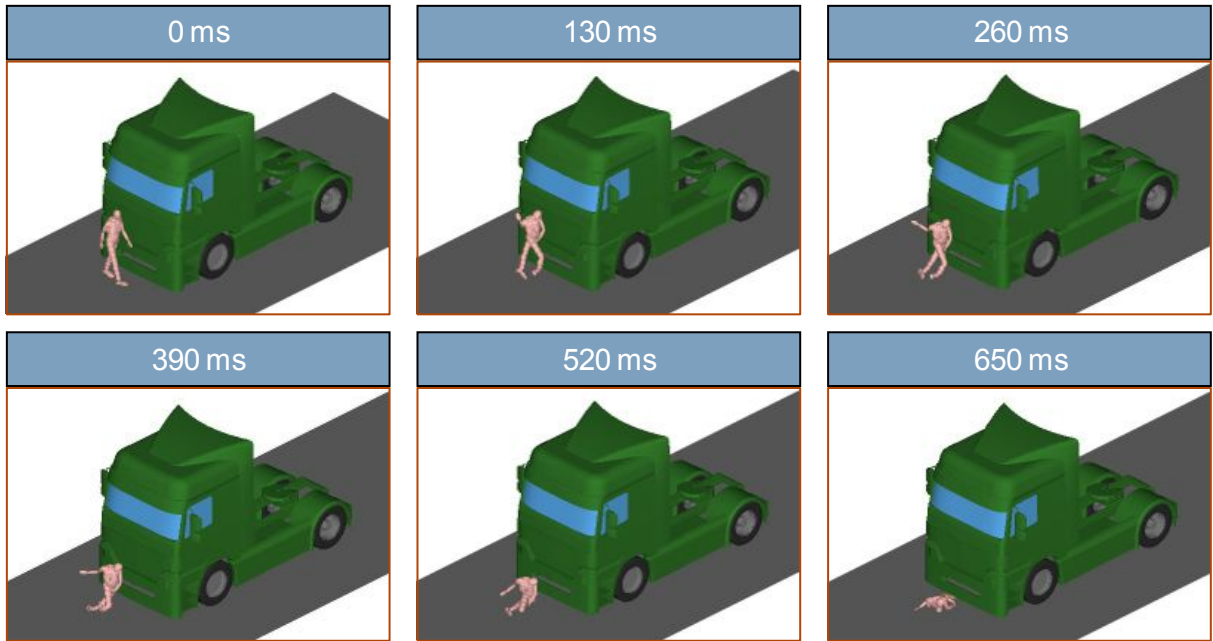


Fig. 13-18: Reference tractor against 95 % male

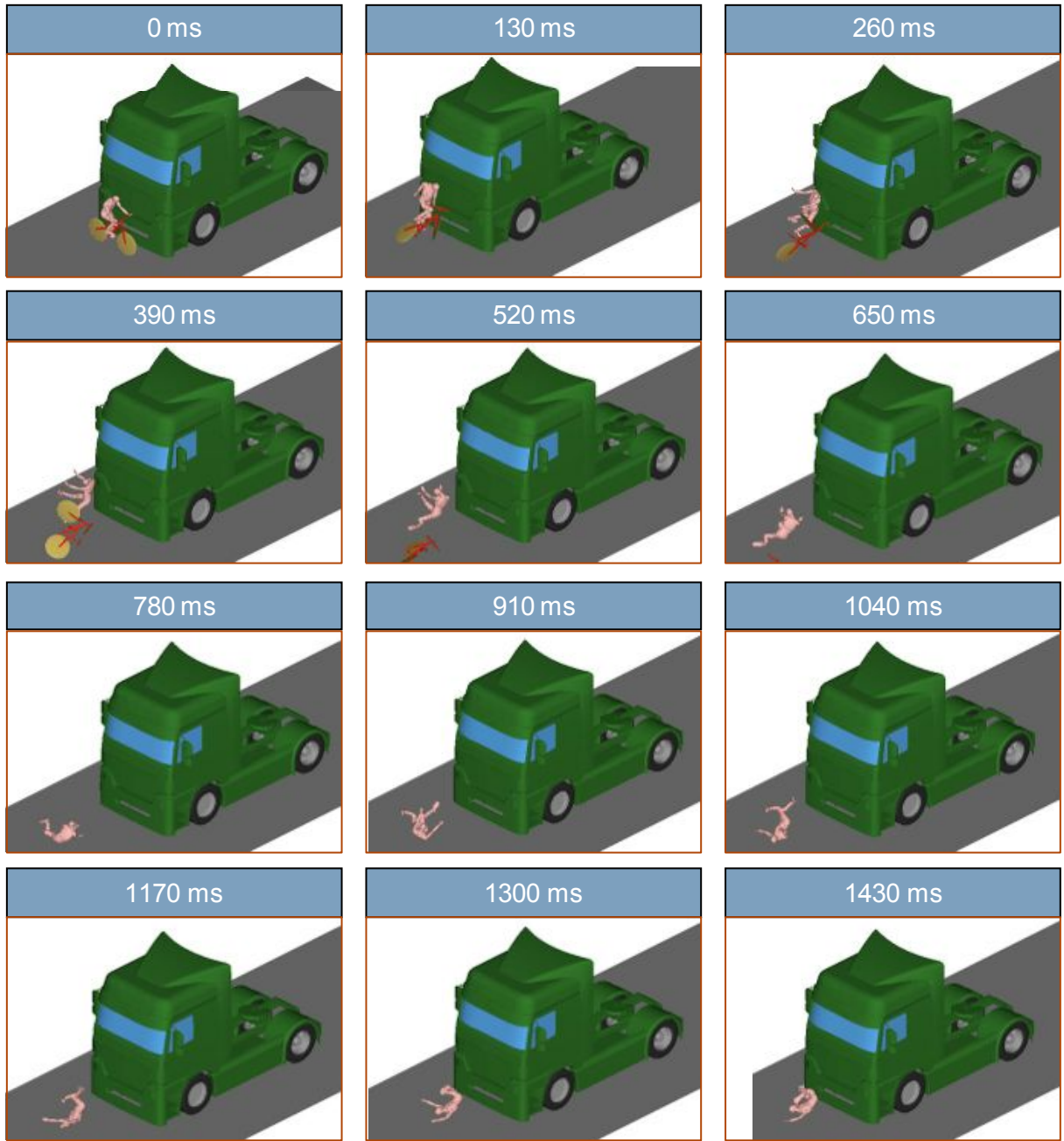


Fig. 13-19: Reference tractor against cyclist

13.4.3 Reference Tractor: Edge Impact

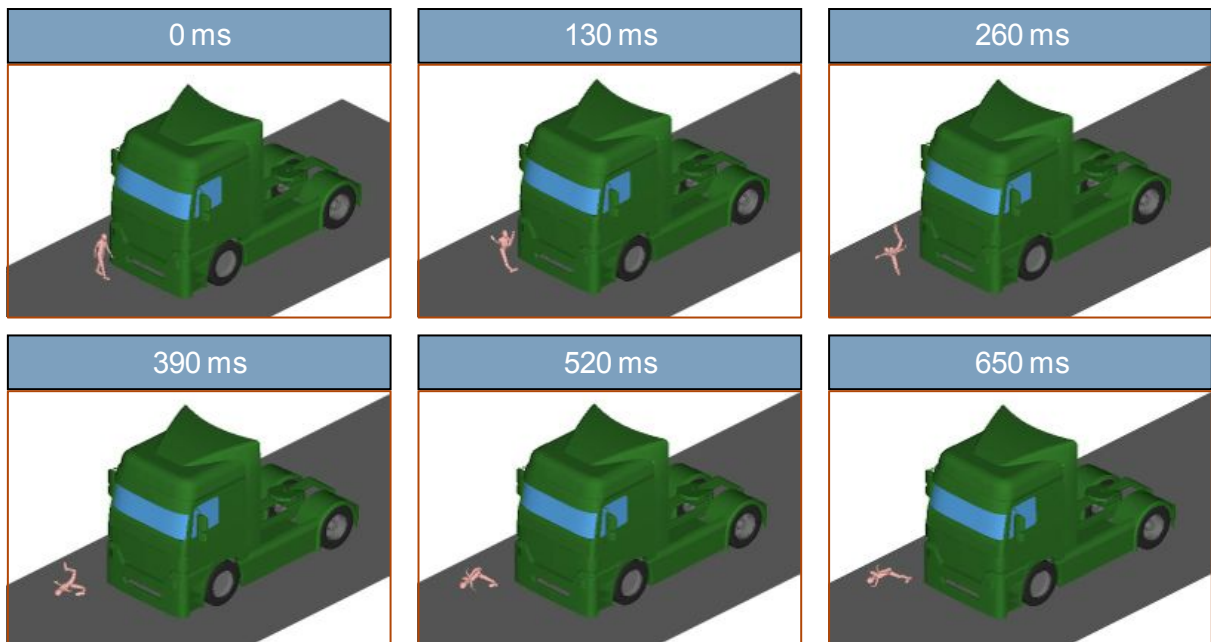


Fig. 13-20: Reference tractor against 6 year old child

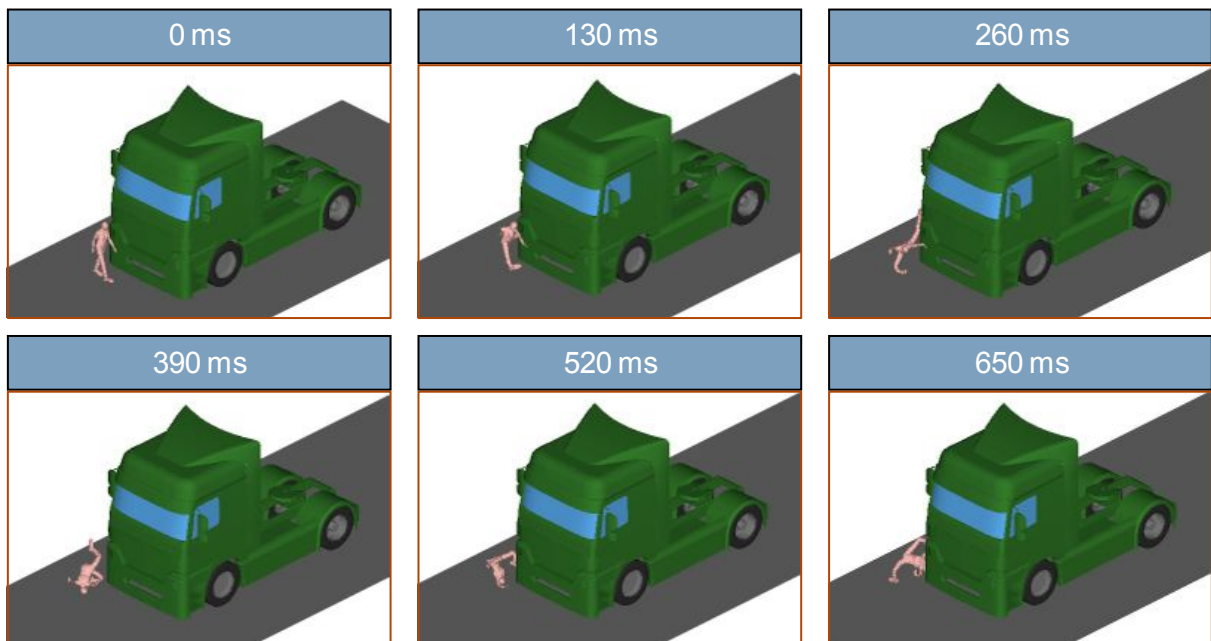


Fig. 13-21: Reference tractor against 5 % female

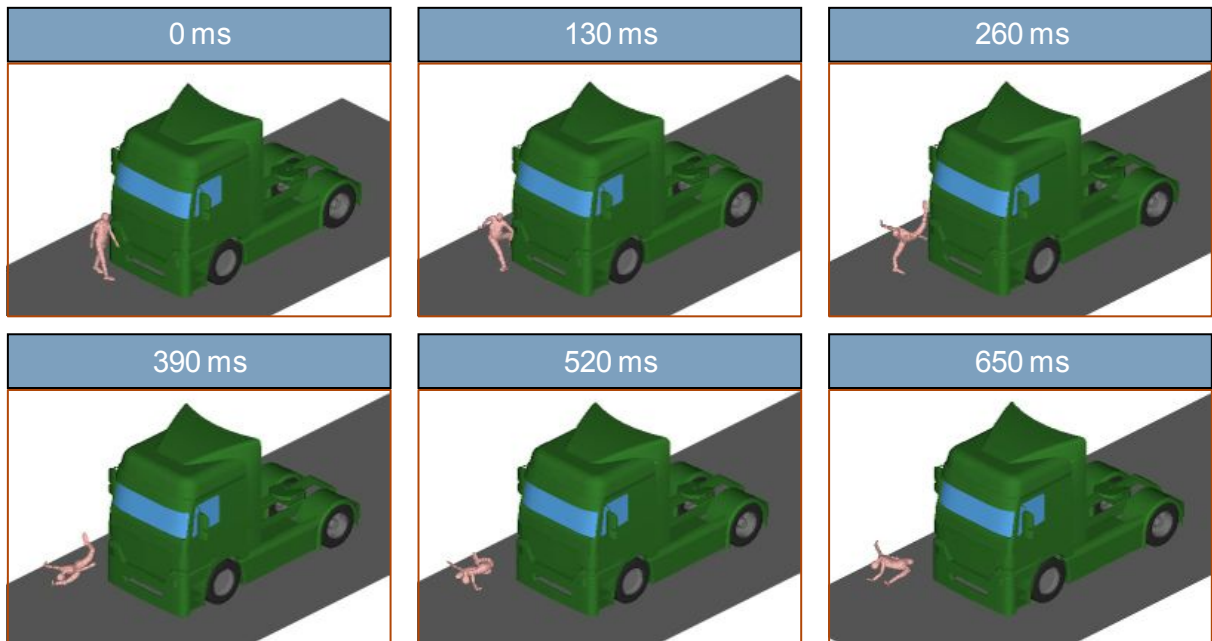


Fig. 13-22: Reference tractor against 50 % male

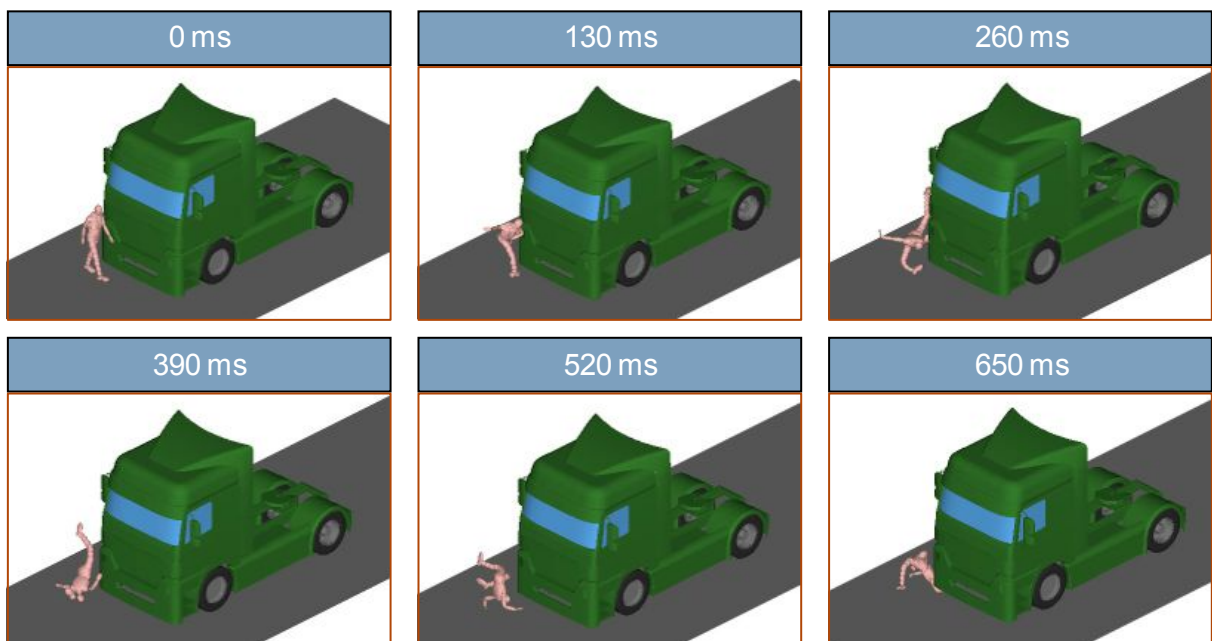


Fig. 13-23: Reference tractor against 95 % male

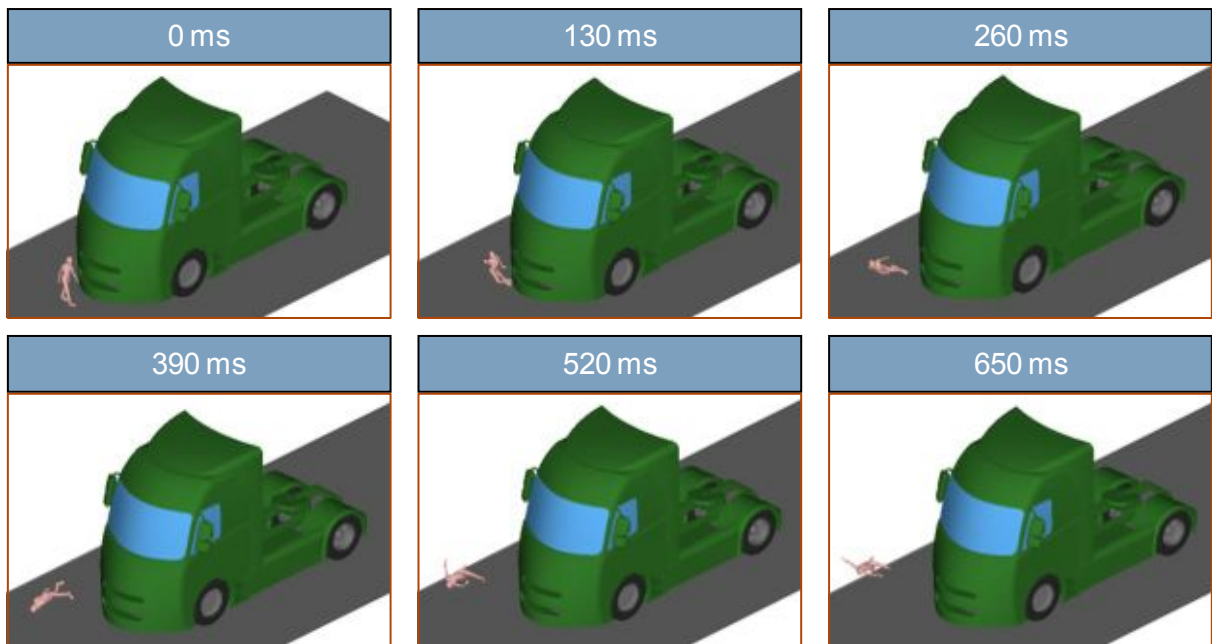
13.4.4 Advanced Concept: Central Impact

Fig. 13-24: Advanced concept against 6 year old child

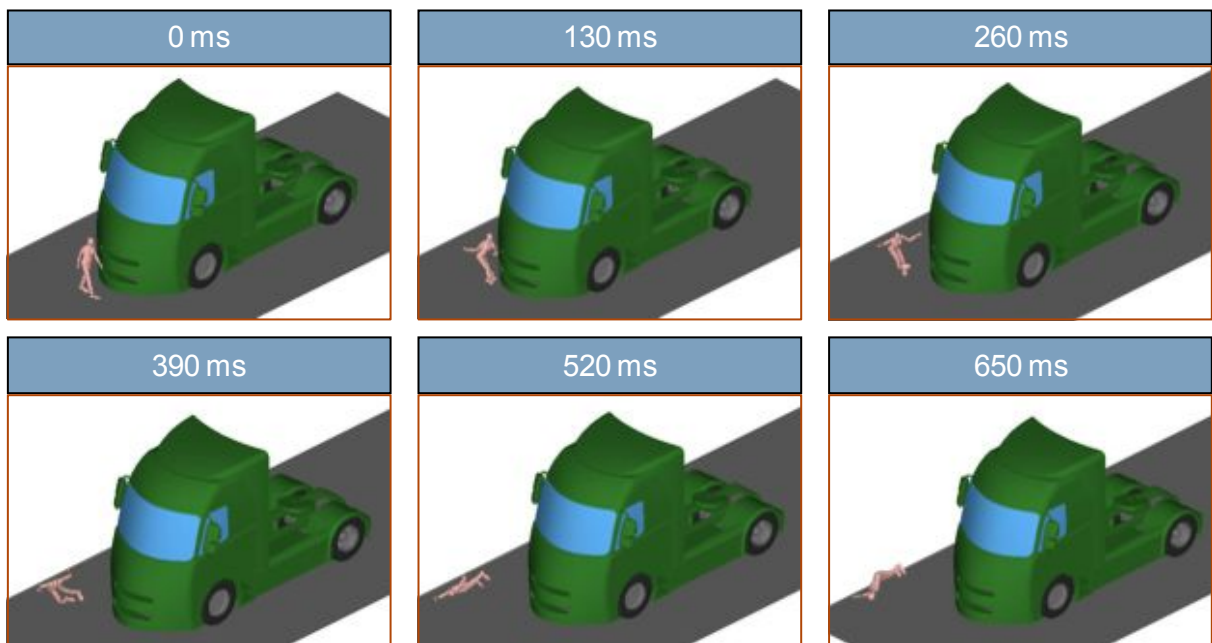


Fig. 13-25: Advanced concept against 5 % female

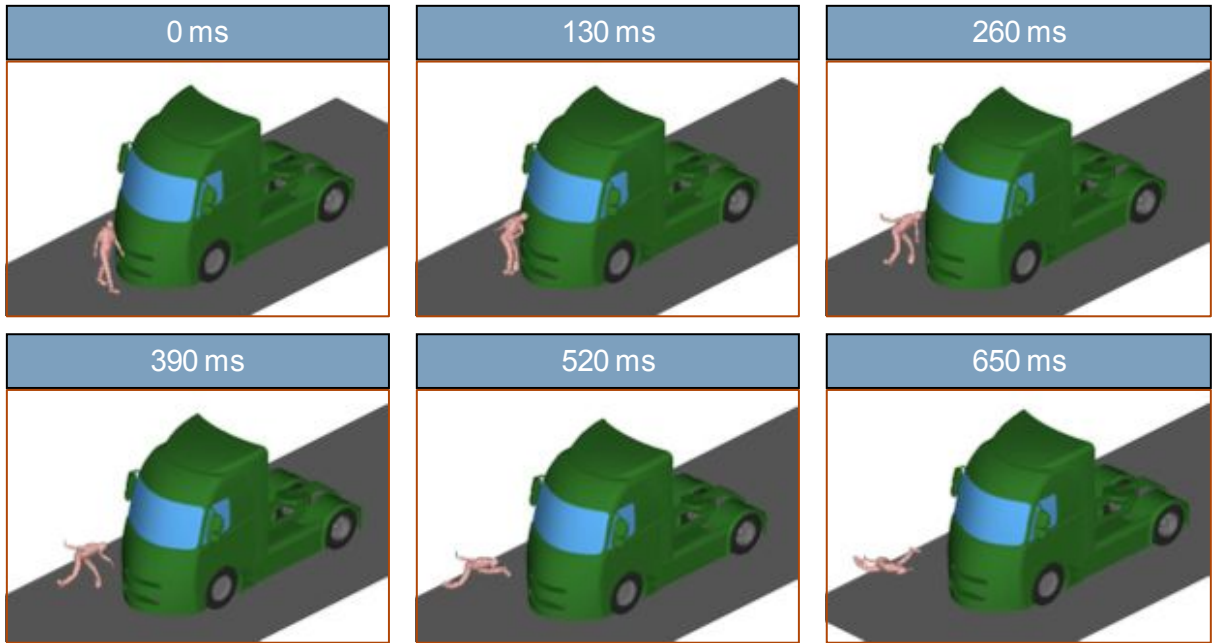


Fig. 13-26: Advanced concept against 95 % male

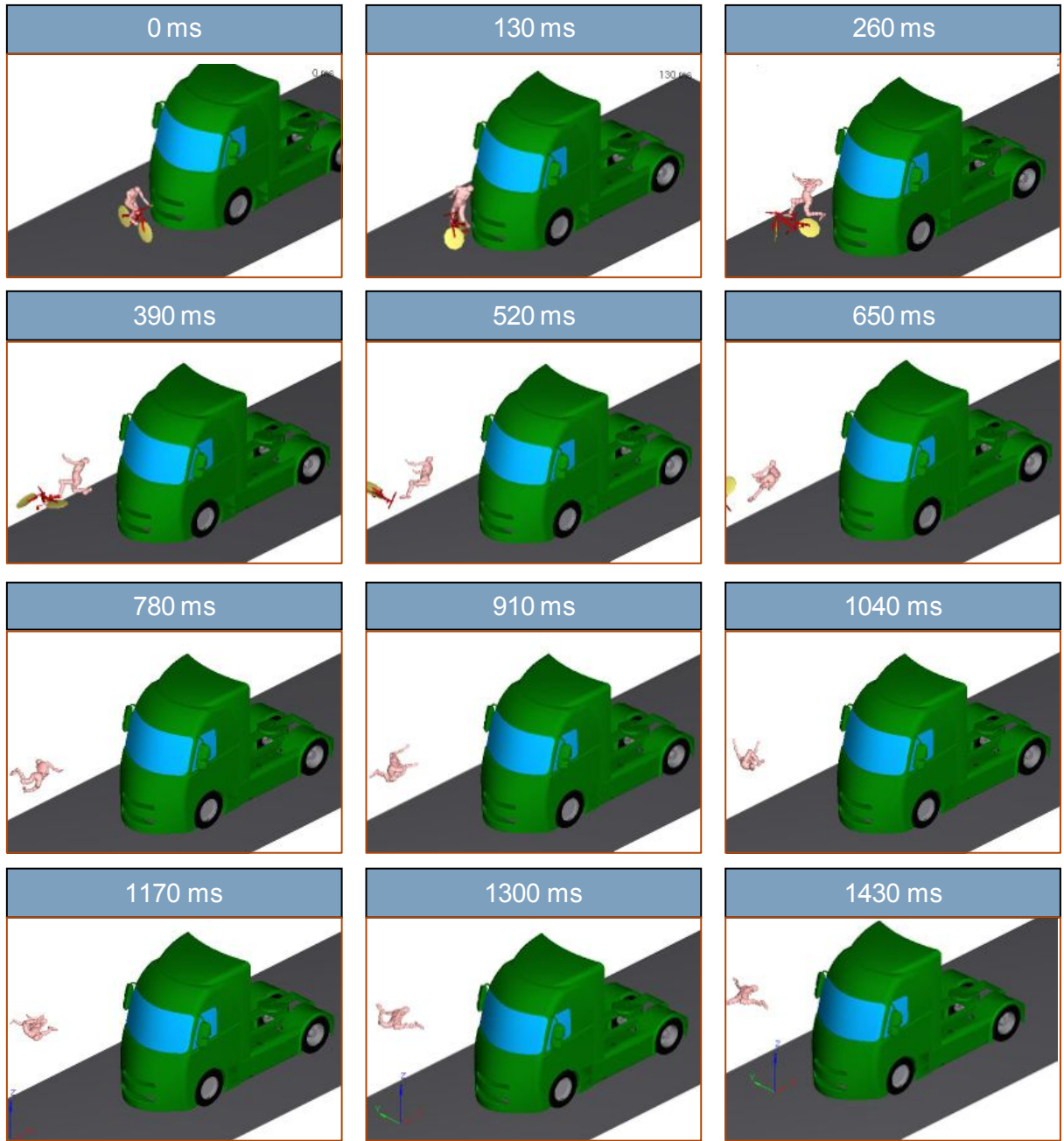


Fig. 13-27: Advanced concept against cyclist

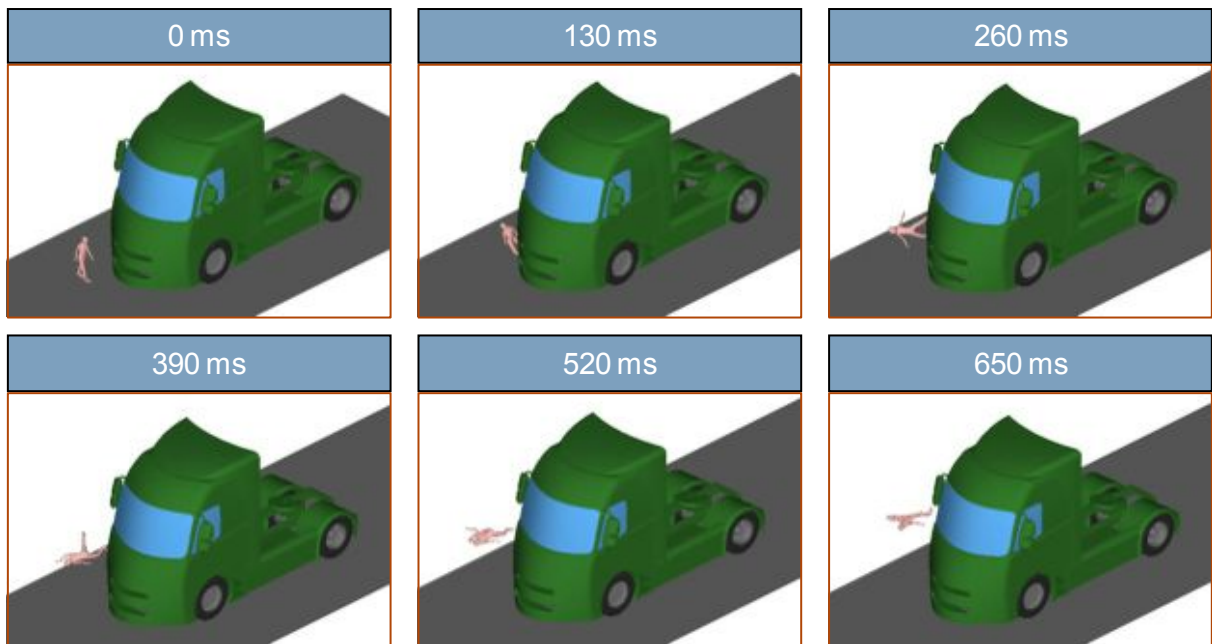
13.4.5 Advanced Concept: Edge Impact

Fig. 13-28: Advanced concept against 6 year old child

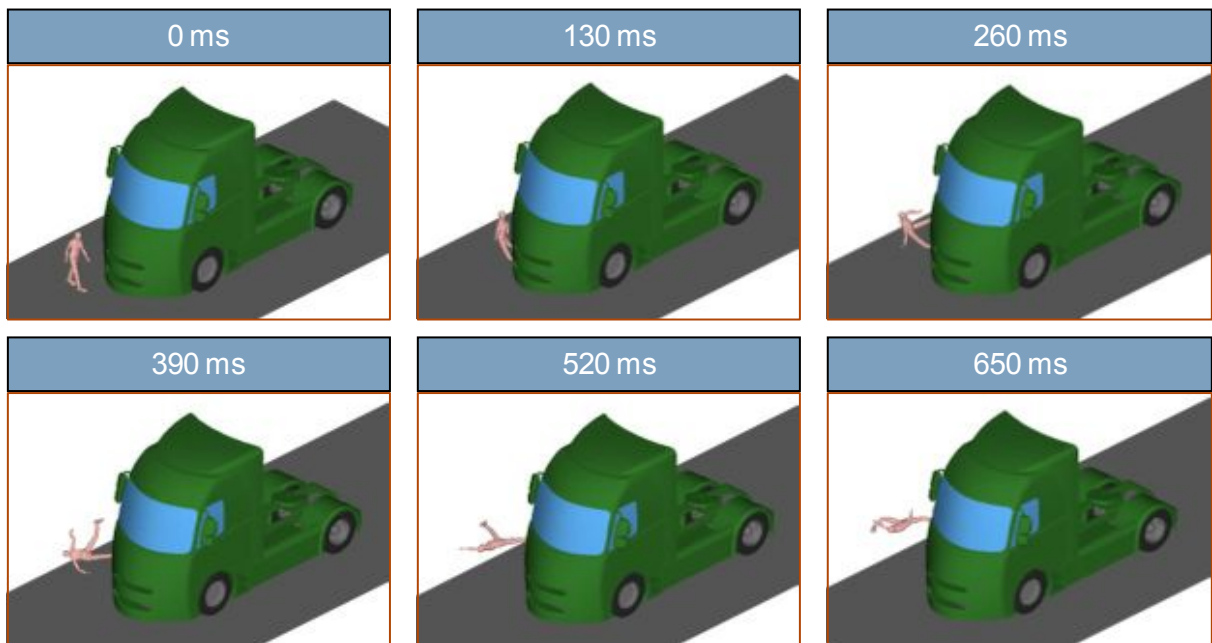


Fig. 13-29: Advanced concept against 5 % female

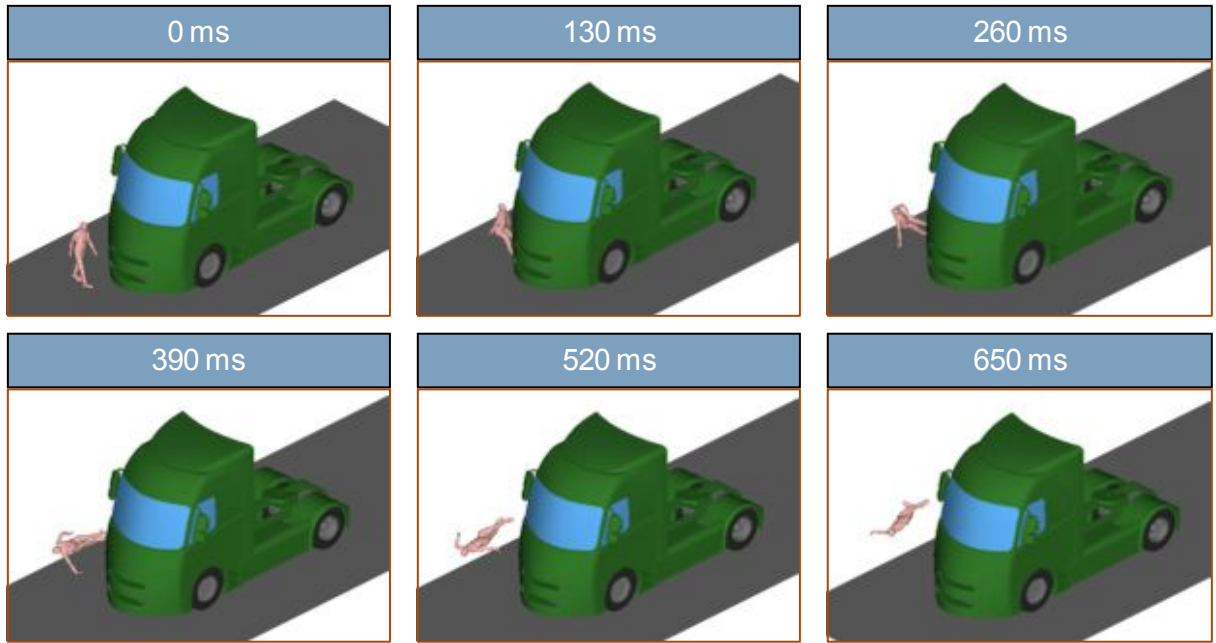


Fig. 13-30: Advanced concept against 50 % male

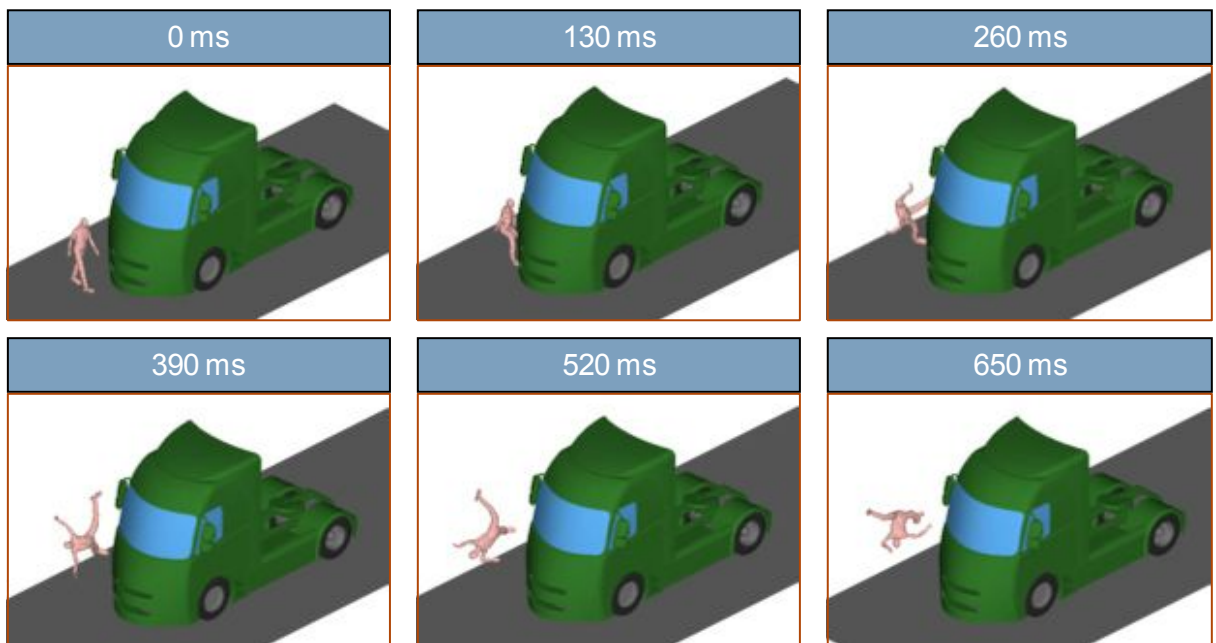


Fig. 13-31: Advanced concept against 95 % male